

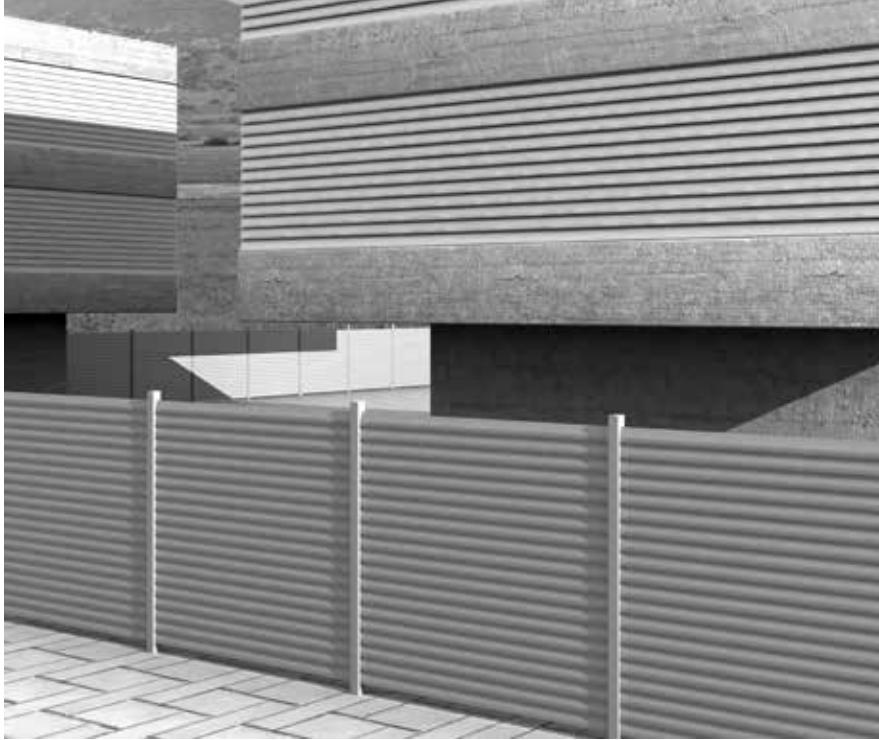

CARACTERÍSTICAS

El sistema Closed nace como sustituto natural a otros materiales tradicionalmente utilizados para la construcción de vallas de jardín y cancelas, por su robustez, estética y caren-

cia de mantenimiento. El amplio catálogo de lamas permite su utilización en cualquier situación, incluso en barandas, puertas, divisorias o corrugables.



SISTEMA CLOSED
LINEAL



SISTEMA CLOSED
PRACTICABLE



SISTEMA CLOSED
CORREDERA

APERTURAS PRINCIPALES

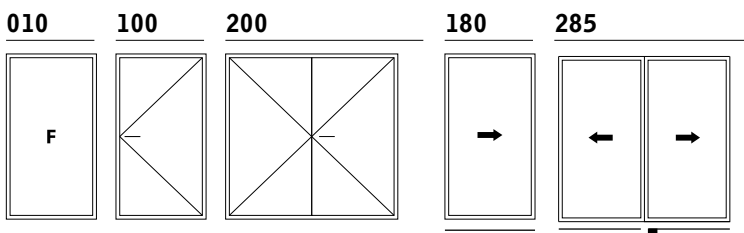

VJ70
1



PERFILES

E: 1/2

PERFILES ESTRUCTURALES

VJ70-0100

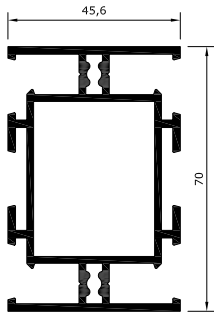

VJ70-3550

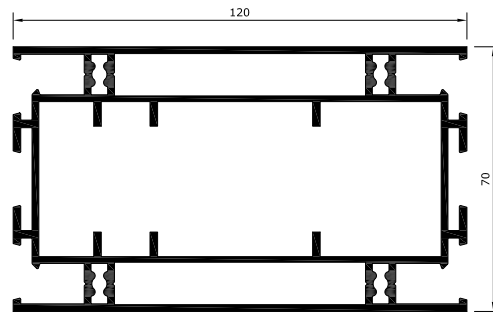

VJ70-3600

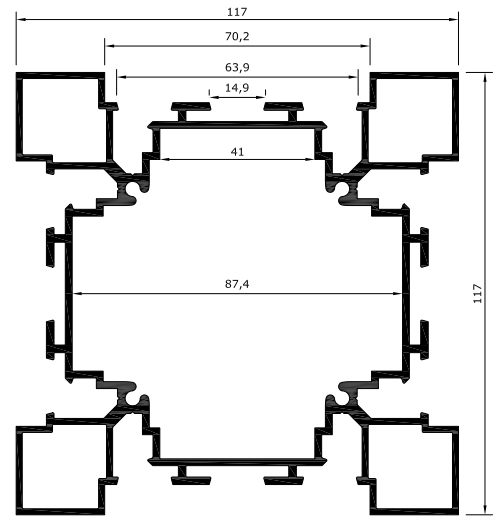

KR4031

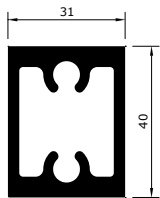

PERFILES PORTALAMAS

VJ70-7099

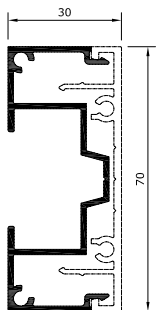

VJ70-1499

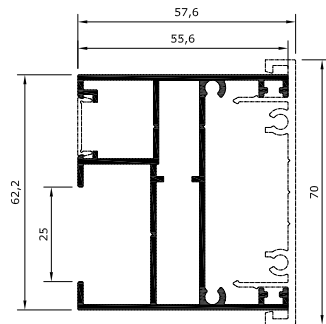

VJ70-0000

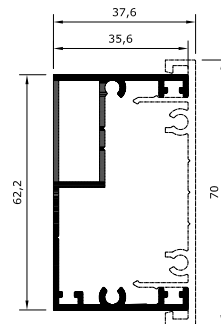

LN03-1499

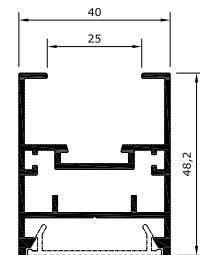

TAPETAS UNIVERSALES

VJ70-7000

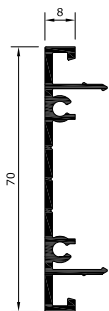

VJ70-7098

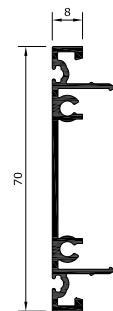

PERFILES INVERSOR

VJ70-2390

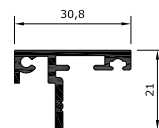

OB30-2390

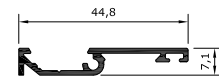

OM60-7000

(2131)

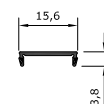

PERFILES

E: 1/2

PERFILES DIVISORIAS

GL40-6099

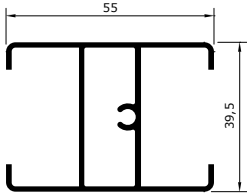

LN03-6099

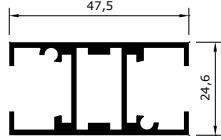

PERFILES GUÍAS

VJ70-9072

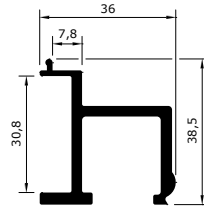

VJ70-7077

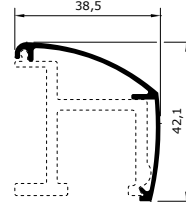

VJ70-9061

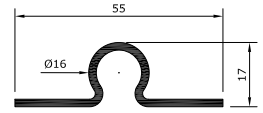

PERFILES COMPLEMENTARIOS

CP01-1850

(11850)

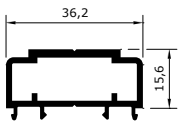

U25

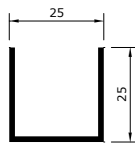

LAMAS FIJAS

XX07-0086

(18152)

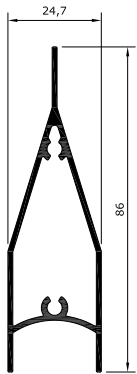

XX07-0094

(74165)

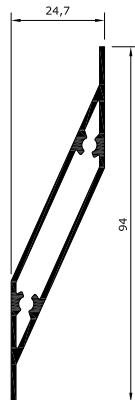

XX06-0062

(66166)

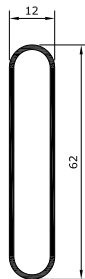

SISTEMA LAMA MÓVIL

XX06-0065

(10010)

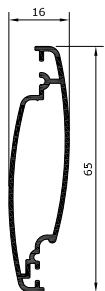

XX06-0011

(10011)

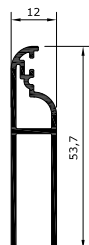

XX06-0012

(10012)

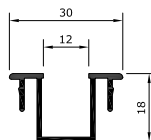



PERFILES

E: 1/2

LAMAS AVIÓN OPACITY

XX06-0160
(11851)

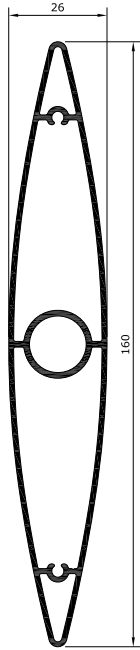

XX06-0210
(11852)

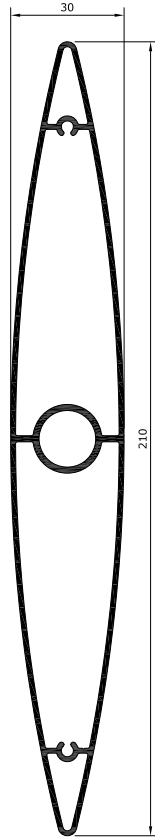

XX06-0320
(11853)

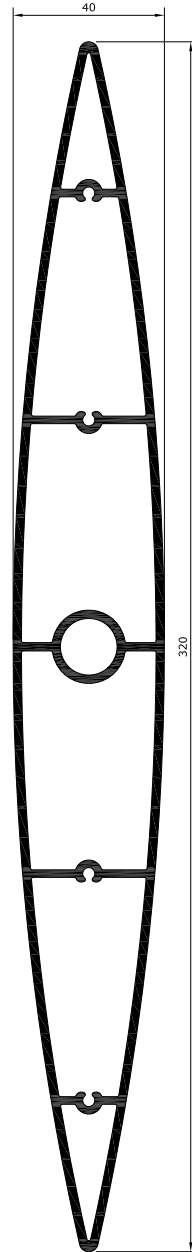

TUBOS / BARROTES

Q25

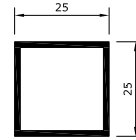

R2515

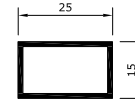

R3520

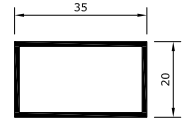

R4025

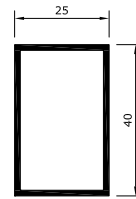

R5025

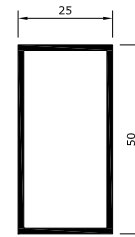

R10025

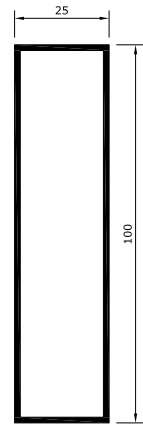

PERFILES

E: 1/2

BARROTES TRADICIONALES

KR3520
(2100)

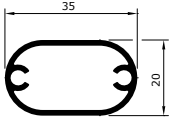

KR3017
(6990)

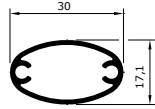

KR3015
(5745)

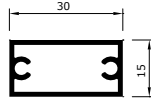

KQ0030
(7956)

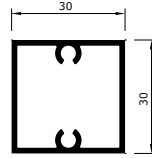

KR5040
(2050)

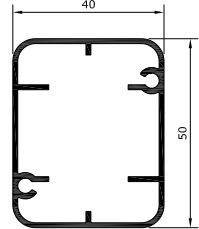

MACHIHEMBRADO

XX09-1410
(11410)

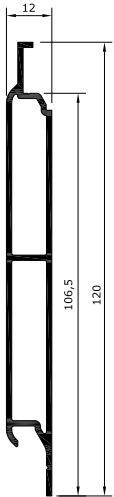

XX09-7992
(7992)

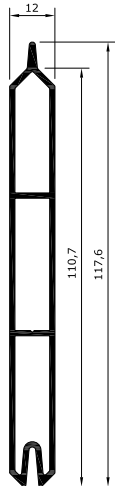

XX09-6346
(6346)

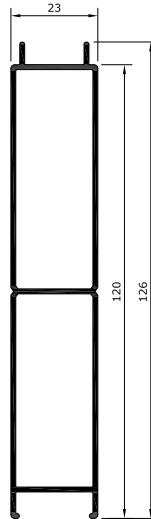

XX09-0140

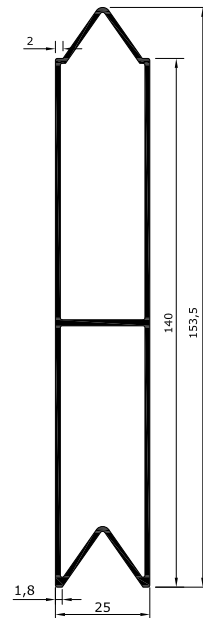















JUNQUILLOS



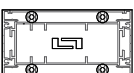
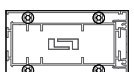

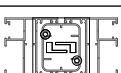
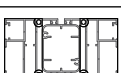

JUNQUILLOS	ESQUEMA	JUNQUILLOS	ESQUEMA
8 mm		38 mm	
13 mm		41,1 mm	
18 mm		43 mm	
23 mm		46,1 mm	
28 mm		48 mm	
31,1 mm		56,1 mm	
33 mm		51,1 mm	
36,1 mm		64,4 mm	

ACCESORIOS

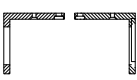

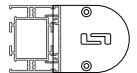

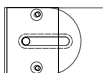



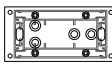

TAPAS ESTÁNDAR

ESQUEMA	REF	DESCRIPCIÓN
	VA70-0010	Tapa superior perfil VJ70-0100 + 2 x VJ70-7000
	VA70-0020	Tapa perfil VJ70-0100 + 2 x VJ70-70099
	VA70-0030	Tapa perfil VJ70-1499
	VA70-0050	Tapa perfil VJ70-0100
	VA70-0060	Tapa perfil VJ70-0100 + 1 x VJ70-7000
	VA70-0080	Tapa perfil VJ70-0100 + 1 x VJ70-7099
	VA70-0090	Tapa perfil VJ70-0100 + 1 x VJ70-7000 + 1 x VJ70-7099
	VA70-9010	Tapa perfil VJ70-3600
	VA70-0110	Tapa perfil VJ70-3550 + 2 x VJ70-7000
	VA70-0120	Tapa perfil VJ70-3550 + 1 x VJ70-7000
	VA70-0150	Tapa perfil VJ70-7099
	VA70-0160	Tapa perfil KR5040 + 2 x VJ70-1499
	VA70-0170	Tapa perfil KR5040 + 2 x VJ70-1499
	VA70-0180	Tapa perfil KR5040 y 1 x VJ70-0000
	VA70-0390	Tapa cantonera 90°

SOLUCIÓN VALLA LINEAL POLIGONAL

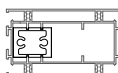
ESQUEMA	REF	DESCRIPCIÓN
	VA70-0340	Kit lateral soporte módulo valla VA70-0300 + VA70-0320 + componentes + tornillería
	VA70-0350	Kit central soporte módulo valla VA70-0300 + VA70-0320 + componentes + tornillería
	VA70-0310	Tapa para VA70-0710, VA70-0340, VA70-0350
	VA70-036A	Kit lateral adaptador módulo perfil LN03-1499 (2 piezas) a VA70-0340
	VA70-036B	Kit lateral adaptador módulo LN03-1499 (4 piezas) a VA70-0350
	VA70-0370	Juego adaptador módulo perfil VJ70-0100 a VA70-0340/VA70-0350
	VA70-0380	Kit tornillos para aplicaciones dobles

SISTEMAS DE ANCLAJE

	TPA0-1251	Compensador para anclaje en sistemas telescópicos VJ70-1499 y VJ70-0000
	VA70-0190	Pie terminal a pared para perfil VJ70-0100 y 1 x VJ70-7000
	VA70-0200	Pie completo para perfil VJ70-0100 y 2 x VJ70-7000
	VA70-0210	Pie para perfil VJ70-3550 y 2 x VJ70-7000
	VA70-9020	Pie para perfil VJ70-7000, VJ70-3600, VJ70-0100 y KR4031
	VA70-0610	Escuadra para la fijación a la pared
	VA70-0220	Manguito
	VA70-022B	Manguito 1 x VJ70-3550
	VA70-022C	Manguito 1 x KR5040
	BA51-0762	Soporte fijación a la pared 100 mm perfil KR4020 o accesorio VA70-022A
	BA51-0908	Perfil KR5040 + KR4020 o accesorio con pie RA908
	BA51-0461	Perfil KR5040 + KR4020 o accesorio con pie RA461







ACCESORIOS

SOLUCIÓN DE CANTONERA

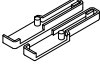
ESQUEMA	REF	DESCRIPCIÓN
	VA70-0390T	Kit 2 x escuadras y tapas para unión montante VJ70-0100 a 90°

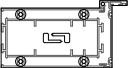
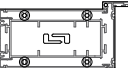

TAPAS PARA INVERSOR VJ70-7000

	OA30-G419	Tapa perfil OB30-2390
	VA70-023A	Tapa VJ70-0100 + 1 x VJ70-2390
	VA70-023B	Tapa perfil VJ70-0100 + 1 x VJ70-2390 + 1 x VJ70-7000
	VA70-023C	Tapa perfil VJ70-0100, VJ70-2390 + 1 x VJ70-7099 + 1 x VJ70-2390
	VA70-028A	Tapa perfil VJ70-3550 + 1 x VJ70-2390
	VA70-028B	Tapa perfil VJ70-3550 + 1 x VJ70-2390 + 1 x VJ70-7000

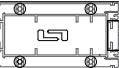

TAPAS PARA PASADOR ESTÁNDAR

	VA70-026A	Tapa perfil VJ70-0100 + 1 x VJ70-7000 para pasador
	VA70-026B	Tapa perfil VJ70-0100 + 2 x VJ70-7000 para pasador
	VA70-027A	Tapa perfil VJ70-3550 + 1 x VJ70-7000 para pasador
	VA70-027B	Tapa perfil VJ70-3550 + 2 x VJ70-7000 para pasador

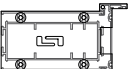
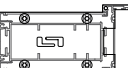

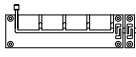

TAPAS PARA PASADOR EN INVERSOR

	VA70-024A	Tapa perfil VJ70-0100 + 1 x VJ70-2390 para pasador
	VA70-024B	Tapa perfil VJ70-0100 + 1 x VJ70-7000 + 1 x VJ70-2390 para pasador
	VA70-029A	Tapa perfil VJ70-3550 + 1 x VJ70-7000 + 1 x VJ70-2390 para pasador
	VA70-029B	Tapa perfil VJ70-3550 + 1 x VJ70-2390 para pasador

PASADORES Y BATIENTES PARA SUELO

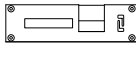
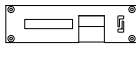
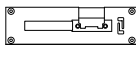
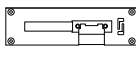
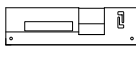
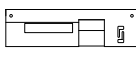
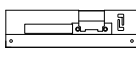
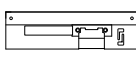
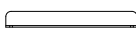

ESQUEMA	REF	DESCRIPCIÓN
	VA70-0250	Batiente central para suelo
	VA70-065A	Contraplaca pasador para perfil VJ70-7000
	VA70-066A	Contraplaca pasador para perfil VJ70-2390
	CPAF-3720C	Pasador TitanDue 220 mm
	CPAF-3721C	Pasador TitanDue 450 mm

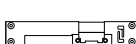
CONTRAPACAS DE MARCO PARA CERRADURA

	VA70-040D	Contraplaca / batiente mano derecha para VJ70-7000
	VA70-040E	Contraplaca / batiente mano izquierda para VJ70-7000
	VA70-041D	Contraplaca / batiente portero electrónico derecha para VJ70-7000
	VA70-041E	Contraplaca / batiente portero electrónico izquierda para VJ70-7000
	VA70-043D	Contraplaca / batiente fijación a obra derecha
	VA70-043E	Contraplaca / batiente fijación a obra izquierda
	VA70-044D	Contraplaca / batiente portero fijación a obra derecha
	VA70-044E	Contraplaca / batiente portero fijación a obra izquierda
	VA70-042A	Batiente regulable 30 mm VA70-0400 / VA70-0410 / VA70-0430 / VA70-0440 / VA70-0450 / VA70-0460
	VA70-042B	Batiente regulable 60 mm VA70-0400 / VA70-0410 / VA70-0430 / VA70-0440 / VA70-0450 / VA70-0460
	VA70-045D	Contraplaca / batiente fijación derecha para VJ70-2390
	VA70-045E	Contraplaca / batiente fijación izquierda para VJ70-2390
	VA70-046D	Contraplaca / batiente portero derecha para VJ70-2390

ACCESORIOS

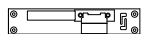



CONTRAPLACAS DE MARCO PARA CERRADURA

ESQUEMA	REF	DESCRIPCIÓN
	VA 70-046E	Contraplaca batiente portero izquierda para VJ70-2390
	VA 70-0490	Contraplaca para valla jardín corredera



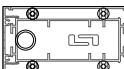
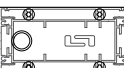

BISAGRAS OPTIMA

	VA 70-0700	Bisagra Optima grande valla de jardín / 2 palas
	VA 70-0800	Bisagra Optima grande Closed / 3 palas
	VA 70-0710	Bisagra Optima mediana valla de jardín / 2 palas
	VA 70-0810	Bisagra Optima mediana Closed / 3 palas
	VA 70-0720	Bisagra Optima pequeña valla de jardín / 2 palas
	VA 70-0820	Bisagra Optima pequeña valla de jardín / 3 palas

BISAGRAS DE PIVOTE - TAPAS

	VA 70-077A	Tapa casquillo pivotante VJ70-0100 + 1 x VJ70-7000
	VA 70-077B	Tapa casquillo pivotante VJ70-0100 + 2 x VJ70-7000
	VA 70-079A	Tapa pivote perfil VJ70-3550 + 1 x VJ70-7000
	VA 70-079B	Tapa pivote perfil VJ70-3550 + 2 x VJ70-7000
	VA 70-078A	Tapa pivote perfil VJ70-0100 + 1 x VJ70-2390
	VA 70-078B	Tapa pivote perfil VJ70-0100 + 1 x VJ70-7000 + 1 x VJ70-2390



BISAGRAS DE PIVOTE - SOPORTES Y EJES

	VA 70-0340	Kit lateral soporte módulo valla VA 70-0300 + VA 70-0320 + componentes + tornillería
	VA 70-0350	Kit central soporte módulo valla VA 70-0300 + VA 70-0320 + componentes + tornillería
	VA 70-0310	Tapa para VA 70-0710 / VA 70-0340 / VA 70-0350
	VA 70-0740	Kit bisagras laterales fijación pared + componentes + tornillería
	VA 70-0750	Tapa superior bisagras VA 70-0740





BISAGRAS DE PIVOTE - SOPORTES Y EJES

ESQUEMA	REF	DESCRIPCIÓN
	VA 70-0730	Kit bisagra pivotante
+ tornillería		
	VA 70-0500	Bisagra superior valla de jardín pivote
	VA 70-0510	Bisagra inferior valla de jardín pivote
	VA 70-0590	Bisagra inferior para el suelo pivote

CERRADURAS PARA CANCELAS ABISAGRADAS

	CPAC-0017	Cerradura con aguja de 35 mm golpe y llave
	CPAC-4040	Bombín de 80 40/40 para sistema Closed
	CPAC-4545 (P7685)	Bombín de 90 45/45 para sistema Closed

MANILLAS Y TIRADORES PARA CANCELAS ABISAGRADAS

	CPA0-4900 (4000)	Unidad maneta
	CPA0-4920 (4014)	Unidad maneta con escudo largo
	CPAF-2060 (F2060)	Pomo fijo HORUS
	CPAF-2100 (F2100)	Escudo decorativo para bombín CPA0-4545 (P7685)



MOTORES Y COMPLEMENTOS PARA CANCELAS ABISAGRADAS

	VA 70-0950	Kit motor batiente
	VA 70-0960	Kit motor con brazos puerta dos hojas
	VA 70-0970	Cerradura electromecánica
	VA 70-0920	Fotocélula emisora / receptora
	VA 70-0930	Lámpara luz destellante



ACCESORIOS

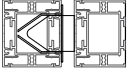

ACCESORIOS ESPECÍFICOS PARA CANCELAS CORREDERAS

ESQUEMA	REF	DESCRIPCIÓN
	VA70-0520	Rodamiento encastrado 60 mm diámetro valla corredera
	VA70-0530	Juego tapa lateral para guía superior valla corredera
	VA70-0540	Sistema guiado forma U superior cancela corredera
	VA70-0550	Sistema guiado forma L superior cancela corredera
	VA70-0580	Centrador de corredera
	CNA0-9605 (93037)	Tirador para cierre CNA0-9804 (904) / CNA0-9885 (904C)

CERRADURAS Y COMPLEMENTOS PARA CANCELAS CORREDERAS

	CPAC-0013 (P359)	Cerradura para puerta corredera
	VA70-0013	Cerradura golpe y llave para puerta corredera Closed
	VA70-0490	Contraplaca para valla de jardín corredera
	VA70-0480	Contraplaca para valla de jardín corredera cerradura VA70-0013
	CPAC-4040	Bombín de 80 40/40 para sistema Closed
	CPAC-4545 (P7685)	Bombín de 90 45/45 para sistema Closed
	CPAF-2100 (F2100)	Escudo decorativo para bombín CPAC-4545 (P7685)

MOTORES Y COMPLEMENTOS PARA CANCELAS CORREDERAS

	VA70-0900	Kit motor corredera
	VA70-0910 (VA91)	Kit cremallera 3 m
	VA70-0940 (VA94)	Kit batería motor corredera

TOPE LIMITADOR APERTURA

	VA70-4002	Tope limitador apertura practicable y corredera
---	-----------	---

ACCESORIOS PARA EL ANCLAJE DE LAMAS FIJAS

ESQUEMA	REF	DESCRIPCIÓN
	XA27-0086 (1942)	Soporte lama XX07-0086
	XA27-0094 (1943)	Soporte lama XX07-0094
	XA26-0062 (K013)	Soporte lama XX06-0062
	XA16-0065 (K020)	Soporte lama ciega XX06-0065
	XA26-0065 (K021)	Soporte lama abierta XX06-0065
	XA2R-3520 (1924)	Soporte tubo R3520
	XA16-0210 (1934)	Soporte fijo 0° lama avión XX06-0210
	XA26-0210 (1935)	Soporte fijo 30° lama avión XX06-0210

ACCESORIOS PARA EL ANCLAJE DE LAMAS MÓVILES







	XA36-0665 (LUC06)	Mecanismo mallorquina LUNA 6 láminas
	XA36-0765 (LUC07)	Mecanismo mallorquina LUNA 7 láminas
	XA36-0865 (LUC08)	Mecanismo mallorquina LUNA 8
	XA36-0965 (LUC09)	Mecanismo mallorquina LUNA 9 lamas 535-590 mm
	XA36-1065 (LUC10)	Mecanismo mallorquina LUNA 10 lamas 590-645 mm
	XA36-1165 (LUC11)	Mecanismo mallorquina LUNA 11 lamas 645-700 mm
	XA36-1265 (LUC12)	Mecanismo mallorquina LUNA 12 lamas 700-755 mm
	XA36-1365 (LUC13)	Mecanismo mallorquina LUNA 13 lamas 755-810 mm
	XA36-1465 (LUC14)	Mecanismo mallorquina LUNA 14 lamas 810-865 mm
	XA36-1565 (LUC15)	Mecanismo mallorquina LUNA 15 lamas 865-920 mm
	XA36-1665 (LUC16)	Mecanismo mallorquina LUNA 16 lamas 920-975 mm
	XA36-1765 (LUC17)	Mecanismo mallorquina LUNA 17 lamas 975-1030
	XA36-1865 (LUC18)	Mecanismo mallorquina LUNA 18 lamas 1030-1085 mm
	XA36-1965 (LUC19)	Mecanismo mallorquina LUNA 19 lamas 1085-1140 mm
	XA36-2065 (LUC20)	Mecanismo mallorquina LUNA 20 lamas 1140-1195 mm

ACCESORIOS





ACCESORIOS PARA EL ANCLAJE DE LAMAS MÓVILES

ESQUEMA	REF	DESCRIPCIÓN
	XA36-2165 (LUC21)	Mecanismo mallorquina LUNA 21 lamas 1195-CPA0-1250 (1250 mm)
	XA36-2265 (LUC22)	Mecanismo mallorquina LUNA 22 lamas CPA0-1250 (1250-1305 mm)
	XA36-2365 (LUC23)	Mecanismo mallorquina LUNA 23 lamas 1305-1360 mm
	XA36-2465 (LUC24)	Mecanismo mallorquina LUNA 24 lamas 1360-1415 mm
	XA36-2565 (LUC25)	Mecanismo mallorquina LUNA 25 lamas 1415-1470 mm
	XA36-6065 (LUC60)	Mecanismo mallorquina LUNA 60 lamas 3300 mm





GOMAS SISTEMA

	CPAG-G900 (3553)	Goma burbuja
	CPAG-G906 (3559)	Goma cuña interior hoja
	VA70-G900	Goma burbuja grande
	VA70-G800 (G600)	Goma antipinzados
	VA70-G810 (G600T)	Tapón terminal para G600
	0A60.G100 (BGC5)	Goma lama móvil

ESCUADRAS ENSAMBLEY ALINEACIÓN FIJAS

	VA70-0600 (VA60)	Escuadra múltiple VJ70-7099
	TPAE-6016 (01006)	Escuadra de tiro 40 x 30 mm
	TPAE-6065 (0465)	Escuadra de tiro 10 x 25 mm
	TPAE-6045 (0445)	Escuadra de tiro 32 x 11 mm
	TPAE-6023 (0423)	Escuadra de tiro 19 x 11 mm
	VA70-7150	Escuadra especial para refuerzo VJ70-3550
	TPAE-6192 (F9002)	Escuadra interior perfil VJ70-3550
	TPAE-7359 (0359)	Escuadra alineación inox

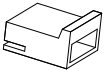
ESCUADRAS REGULABLES

ESQUEMA	REF	DESCRIPCIÓN
	TPAE-8110	Escuadra regulable 25 x 15 mm
	TPAE-8015 (L81015)	Escuadra de tiro regulable 25 x 15 mm
UNIONES FIJAS		
	TPAE-6148 (U408)	Unión reforzada 15 x 18 mm
	TPAE-6043 (K003)	Unión travesaño mallorquina
	VA70-0630	Unión frontal montante VJ70-0100
	D7981 TX48X60	Tornillo de inox 4,8 x 60 mm

UNIONES REGULABLES

	TPAE-8144 (U411)	Unión regulable 15 x 18 mm
---	------------------	----------------------------



VALLA FIJA
VA70(B2=10(XX07-006));0

E: 1/2

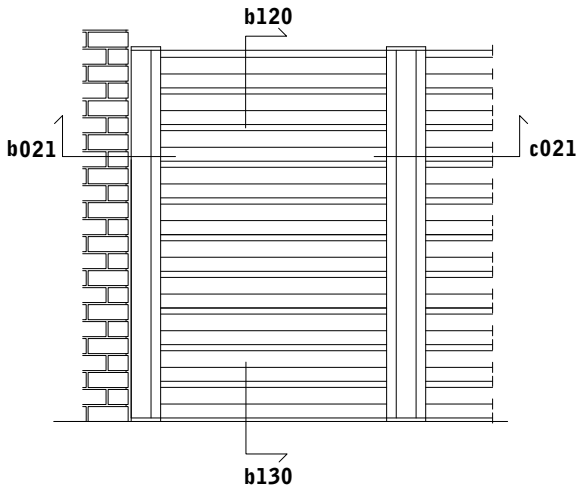

SECCIÓN VERTICAL
b120-b130

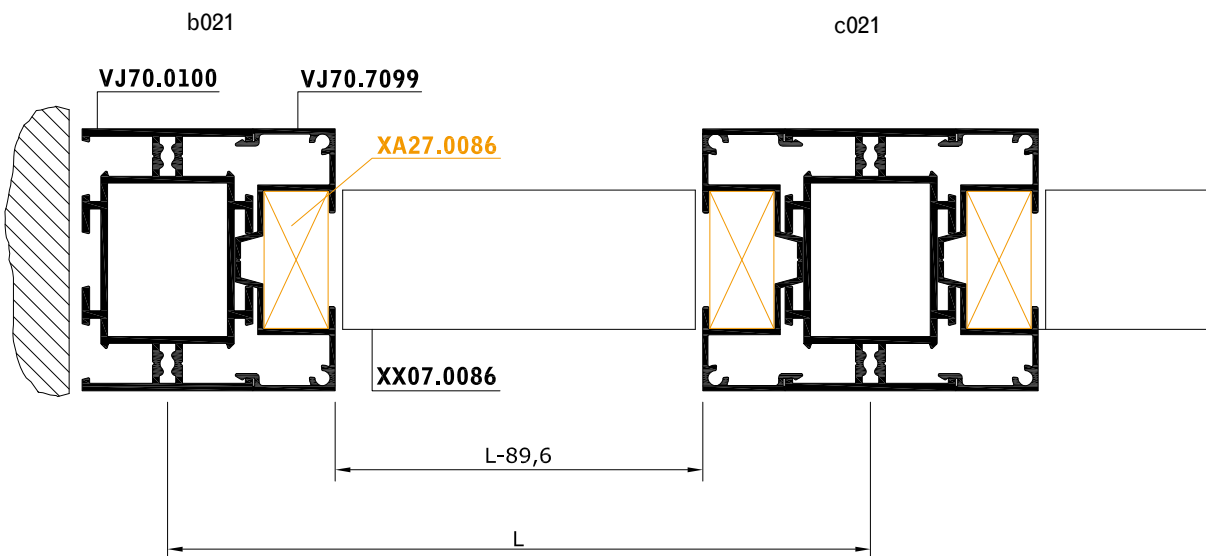
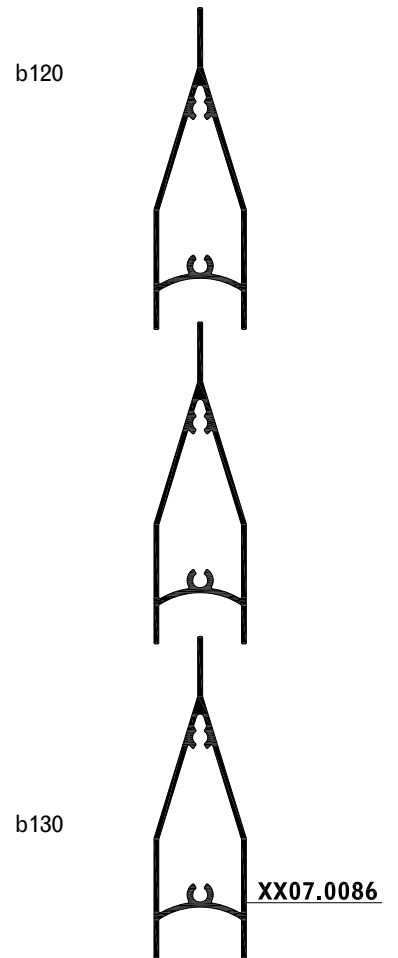

SECCIÓN HORIZONTAL b021-c021

PUERTA CANCELA DE DOS HOJAS

VA70(B2=200E(XX07-0094));0

E: 1/3

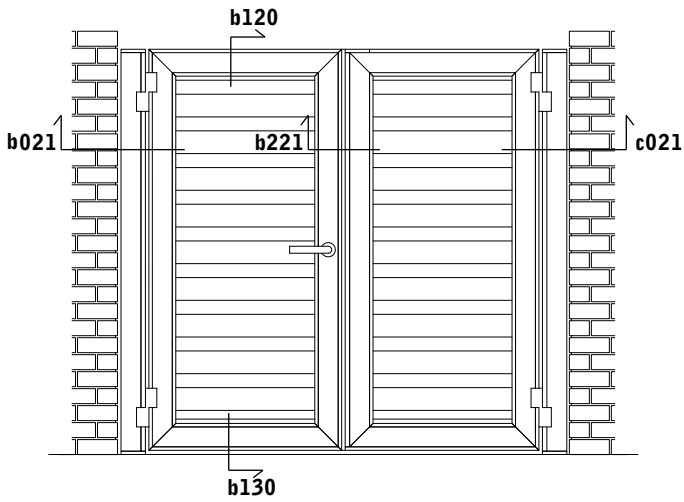

INVERSOR VJ70-2390: H-16

SECCIÓN VERTICAL
b120-b130

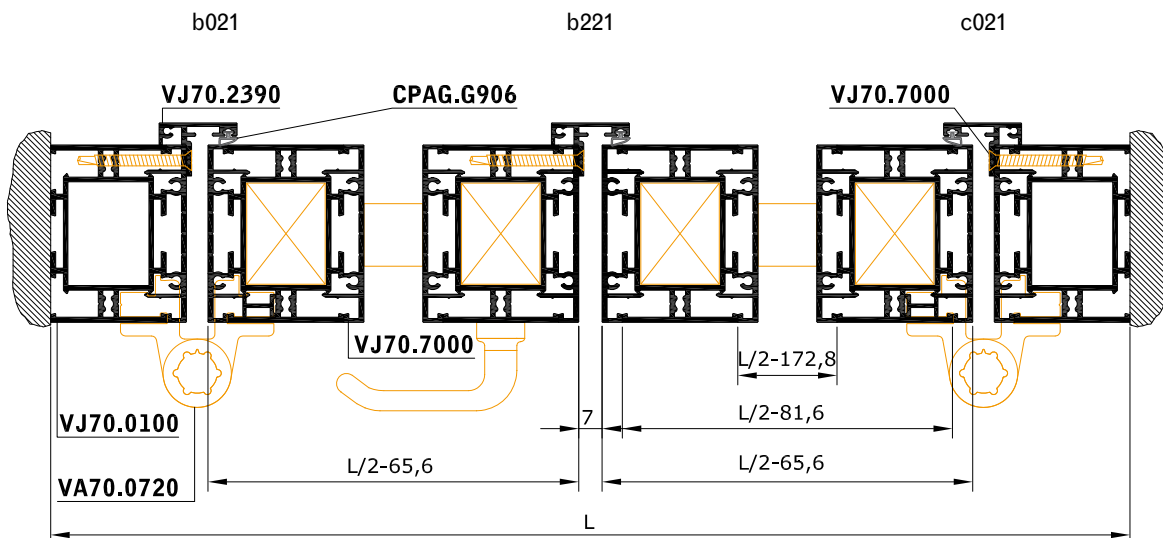
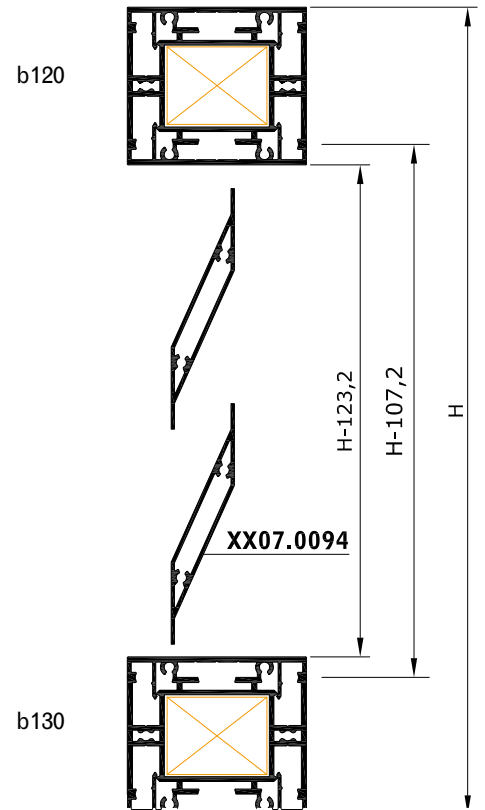

SECCIÓN HORIZONTAL b021-b221-c021



PUERTA CANCELA 1 HOJA CORREDERA
VA70(B2=80D(XX07-0094));0

E: 1/3

SECCIÓN VERTICAL
b120-b130

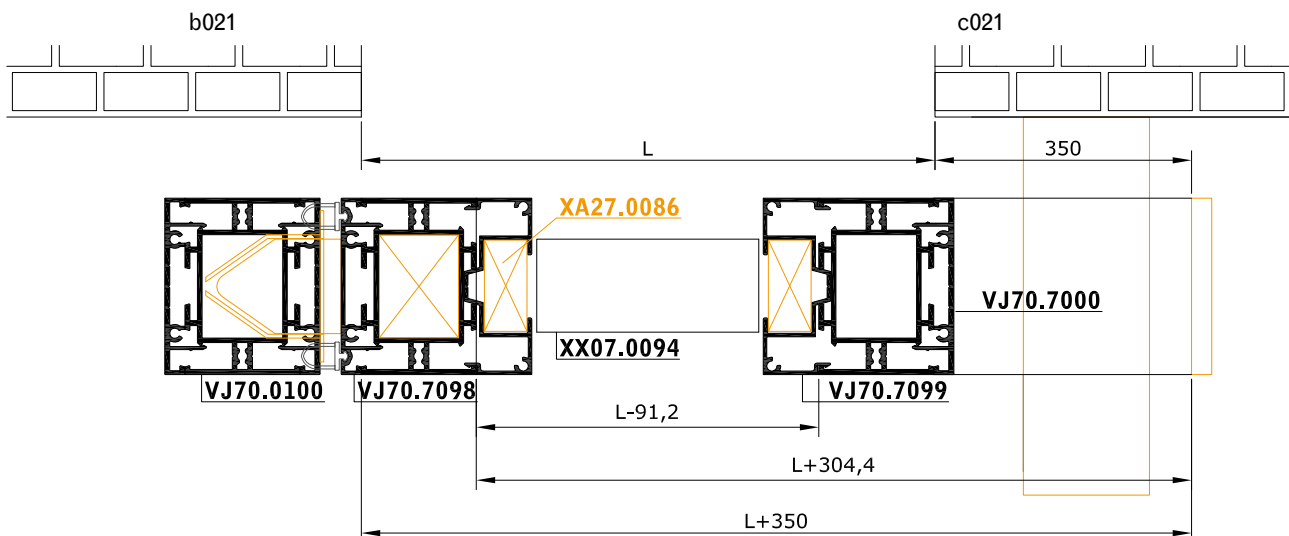
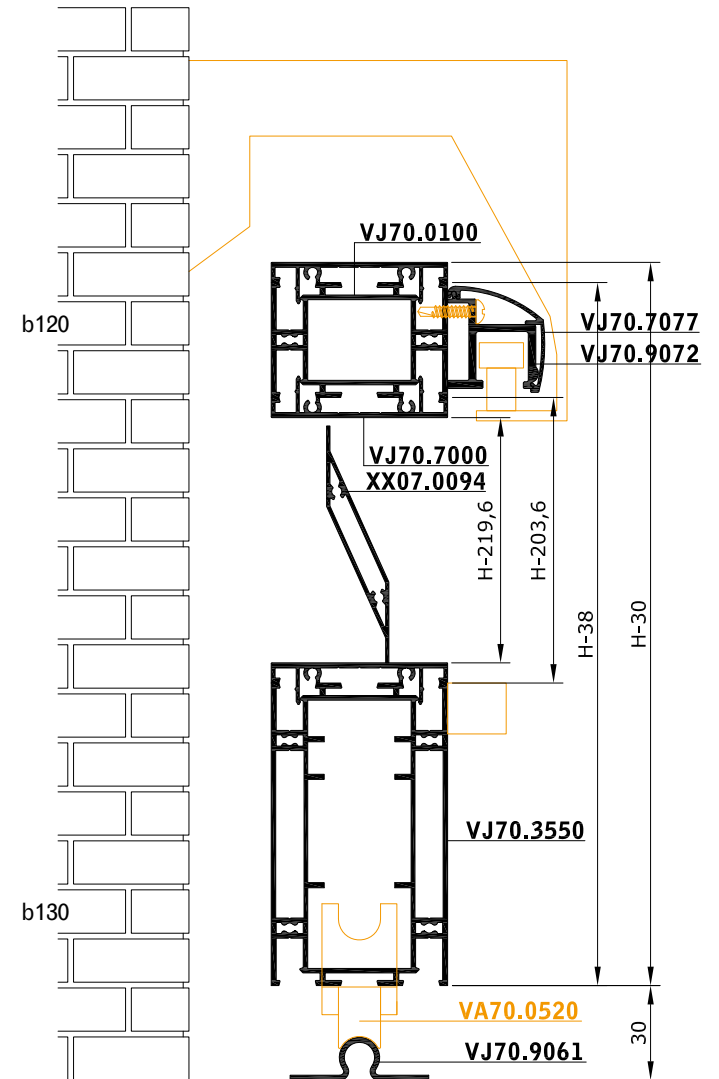
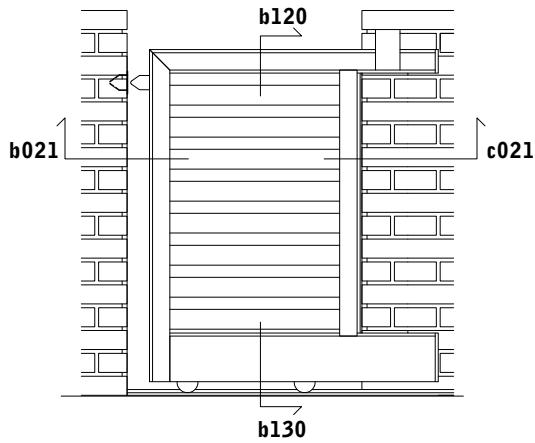

SECCIÓN HORIZONTAL b021-c021

VJ70
14