

Puerta de calle robusta que destaca por su estética, versatilidad y seguridad. Estéticamente se presenta en dos líneas: cantos romos y rectos. La primera presenta unas formas armónicas y agradables, siendo la elipse la forma geométrica aglutinadora del sistema. La segunda, más vanguardista y acorde con las tendencias arquitectónicas actuales, permite la realización de ejecuciones complejas, como puertas de vaivén, puertas con muelle en el suelo, muelle oculto, etc. así como puertas amplias y pesadas. Sistema total-

mente compatible con las series Practic 40 y Alfil 45. Así, se construyen todo tipo de estructuras combinando la puerta con fijos o ventanas. El grosor de los perfiles, junto con el nuevo sistema de cerradura automática y las contraplacas integradas en el perfil, les confiere una seguridad superior. Sistema adaptado a la normativa francesa. Así, dispone de tapajuntas con fijación frontal y de sistemas de cierre inferiores específicamente apropiados.

OF52
1

Dimensiones base:	Marco:	52 mm
	Hoja:	52 mm
Espesor máximo del cristal:		34 mm
Peso máximo de la hoja:		150 kg

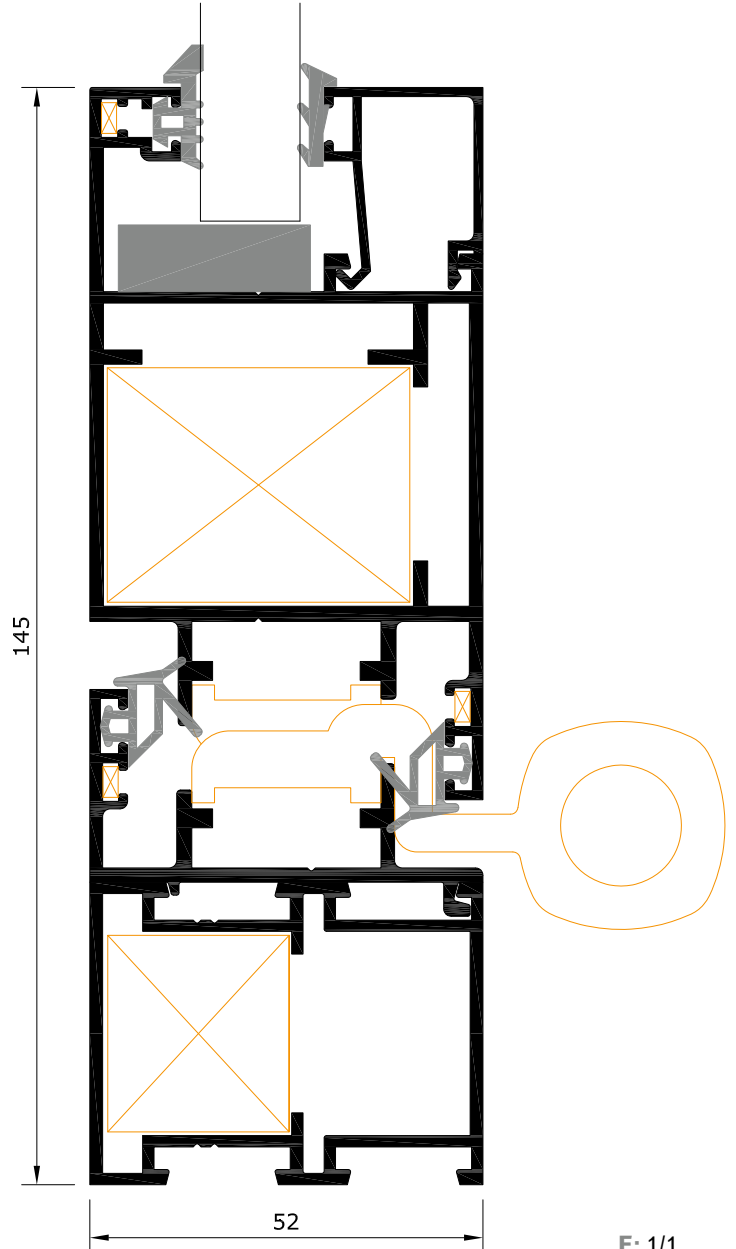

APERTURAS PRINCIPALES

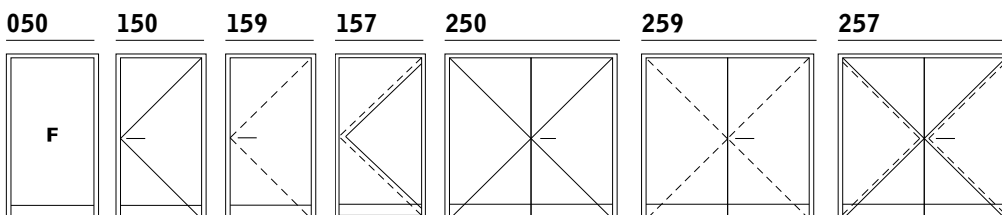

E: 1/1

MEDIDAS HOJA. BISAGRAS DE 2 PALAS
PUERTAS RESIDENCIALES MÁX. 90 KG

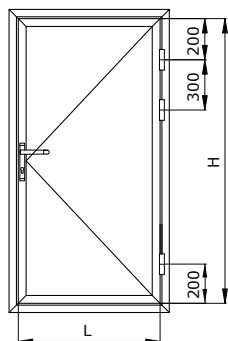

H (mm)	≤800	900	1000	1100	1200	1300	1400
3000	90	90	90	90	90	90	90
2900	90	90	90	90	90	90	90
2800	90	90	90	90	90	90	90
2700	90	90	90	90	90	90	84
2600	90	90	90	90	90	90	78
2500	90	90	90	90	90	87	71
2400	90	90	90	90	90	77	65
2300	90	90	90	90	83	70	58
2200	90	90	90	90	75	63	52
2100	90	90	90	82	68	56	45
2000	90	90	90	74	60	49	39

OF52
2

PUERTAS RESIDENCIALES MÁX. 100 KG

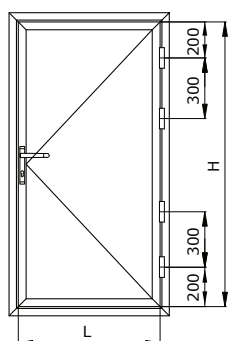

H (mm)	≤800	900	1000	1100	1200	1300	1400
3000	100	100	100	100	100	100	100
2900	100	100	100	100	100	100	100
2800	100	100	100	100	100	100	100
2700	100	100	100	100	100	100	93
2600	100	100	100	100	100	100	86
2500	100	100	100	100	100	93	79
2400	100	100	100	100	100	85	72
2300	100	100	100	100	92	77	65
2200	100	100	100	100	84	70	58
2100	100	100	100	91	75	62	50
2000	100	100	100	82	67	54	43

MEDIDAS HOJA. BISAGRAS DE 3 PALAS
PUERTAS RESIDENCIALES MÁX. 135 KG

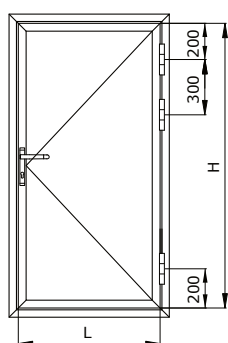

H (mm)	≤800	900	1000	1100	1200	1300	1400
3000	135	135	135	135	135	135	135
2900	135	135	135	135	135	135	135
2800	135	135	135	135	135	135	135
2700	135	135	135	135	135	135	126
2600	135	135	135	135	135	135	116
2500	135	135	135	135	135	125	107
2400	135	135	135	135	135	115	97
2300	135	135	135	135	124	104	87
2200	135	135	135	135	113	94	78
2100	135	135	135	123	102	84	68
2000	135	135	135	111	90	73	58

PUERTAS RESIDENCIALES MÁX. 150 KG

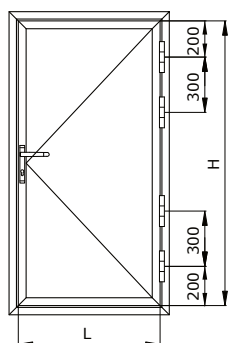

H (mm)	≤800	900	1000	1100	1200	1300	1400
3000	150	150	150	150	150	150	150
2900	150	150	150	150	150	150	150
2800	150	150	150	150	150	150	150
2700	150	150	150	150	150	150	140
2600	150	150	150	150	150	150	129
2500	150	150	150	150	150	139	118
2400	150	150	150	150	150	127	108
2300	150	150	150	150	138	116	97
2200	150	150	150	150	125	104	86
2100	150	150	150	137	113	93	75
2000	150	150	150	123	100	81	65

Puertas edificios públicos	=	Puertas residenciales -10 kg
Puertas edificios públicos con cierrapuertas sin retención en apertura	=	Puertas residenciales -20 kg
Puertas edificios públicos con cierrapuertas con retención en apertura	=	Puertas residenciales -30 kg

■ Medidas no recomendables



MARCOS

OF52-0500 **B** **LB** **BLR**
(5050)

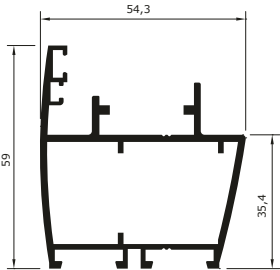

OF52-0400 **B** **LB**
(5070)

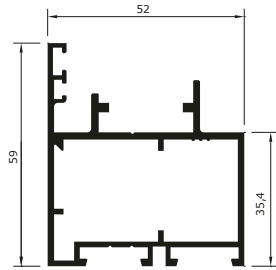

OF52
3

HOJAS APERTURA INTERIOR

OF52-1360 **B** **LB** **BLR**
(5051)

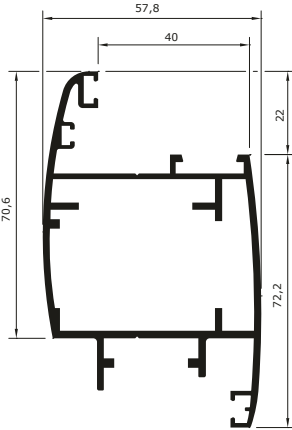

OF52-1390 **B** **LB**
(5071)

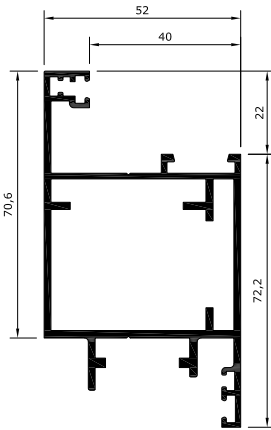

HOJAS APERTURA EXTERIOR

OF52-1960 **B** **LB** **BLR**
(5054)

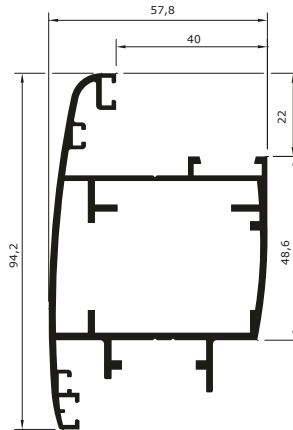

OF52-1990 **B**
(5074)

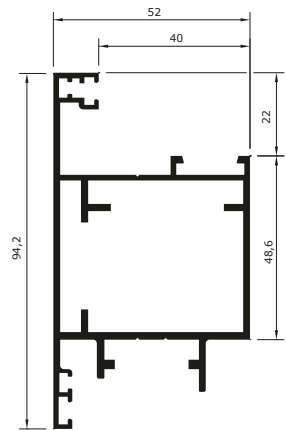

INVERSOR

OF52-2360 **B** **LB** **BLR**
(5053)

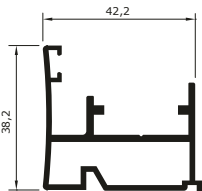

TAPETA CANAL

OT65-7000 **B**

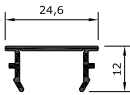

PERFILES ESTRUCTURALES (MONTANTES, TRAVESAÑOS, ZÓCALOS Y CANTONERAS)

PF43-3140 B LB BLR
(60893)

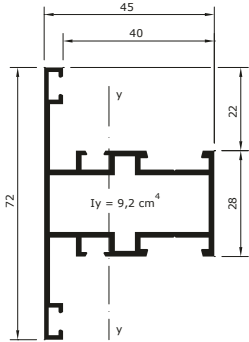

PF43-3340 B LB BLR
(62285)

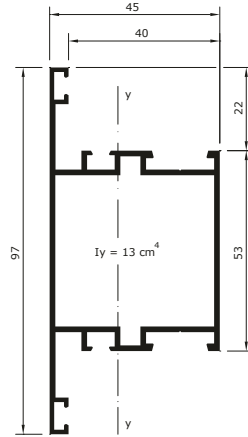

OF52-3540 B LB BLR
(5052)

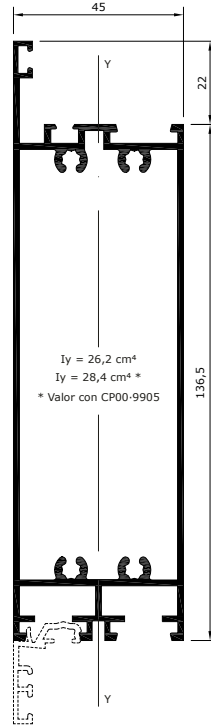

PF43-3440 B LB
(60538)

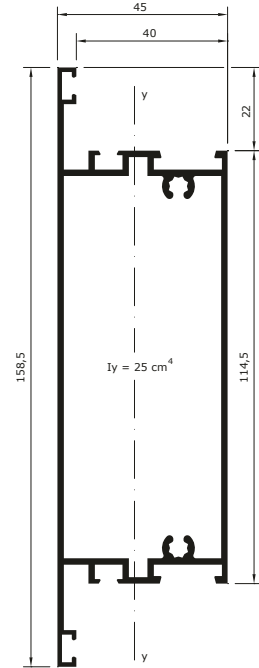

OF52
4

OF52-3090 B LB
(5060)

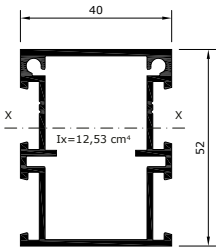

OF52-3060 B LB BLR
(5060)

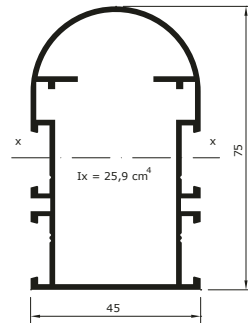

OF52-3099 B
NOVEDAD

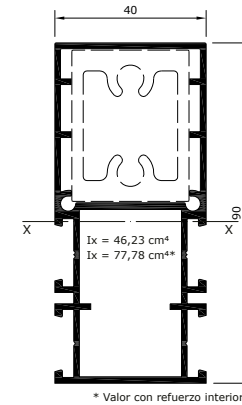

PF43-3600 B LB BLR
(59966)

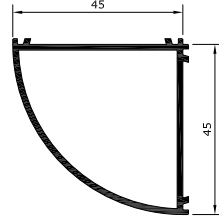

PERFILES ESTRUCTURALES DE REFUERZO UNIVERSALES

TP07-0279 B
(5063)

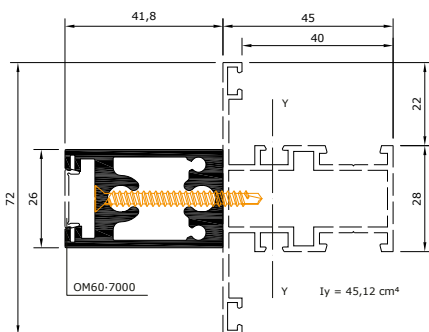

NT10-0279 B
NOVEDAD

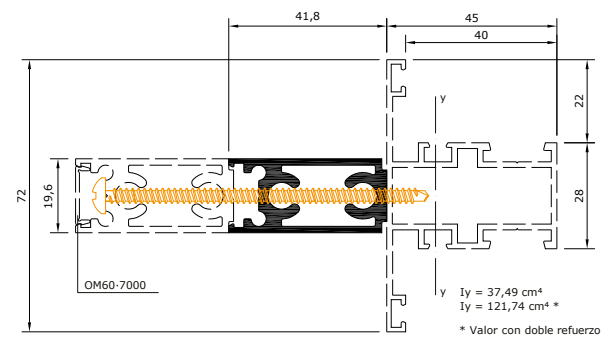

CONVERTIDORES SISTEMA

CP00-9905 B LB PM BLR
(5063)

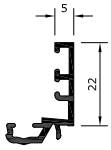

CP00-9708 B LB PM BLR
(5055)

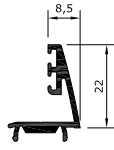

OF52-0005 B LB

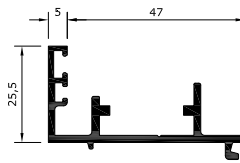

OF52-0000 B LB
(5065)

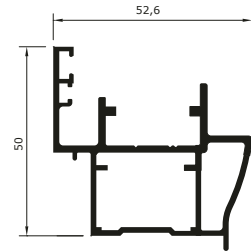

OF52
5

TAPAJUNTAS

OF52-7098 B LB
(5064)

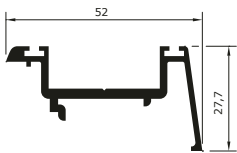

OF52-0800 PM
(11722)

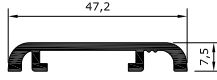

OM60-7098 B LB BLR
(69865)

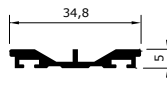

TP09-0030 B LB
(64537)

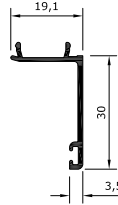

TAPÉES

TE29-0047 B
(L8114)

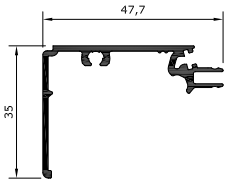

TE29-0067 B
(L8117)

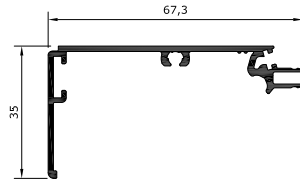

TE29-0042 B
(L8116)

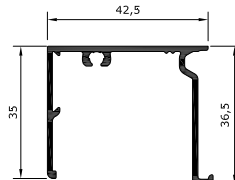

GLOSARIO PERFILES COMPATIBLES DE OTRAS SERIES COMBINABLES

PF43-0400 B LB BLR
(58958)

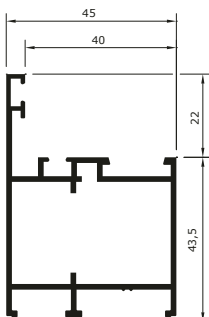

PF43-0100 B LB BLR
(58955)

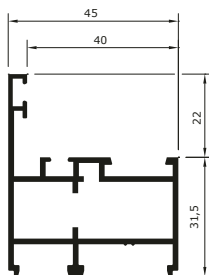

PF43-0601 B LB BLR
(65610)

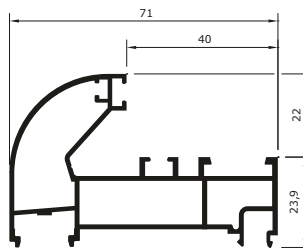

PF43-1160 B LB BLR
(62673)

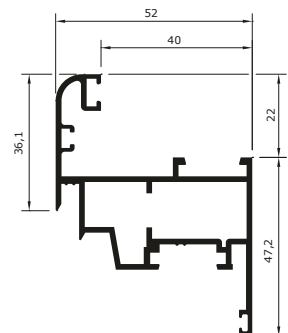

GLOSARIO PERFILES COMPATIBLES DE OTRAS SERIES COMBINABLES

PF43-1190 B LB BLR
(59735)

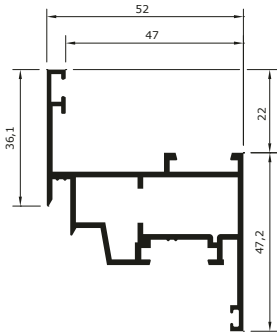

PF43-1290 B
(59736)

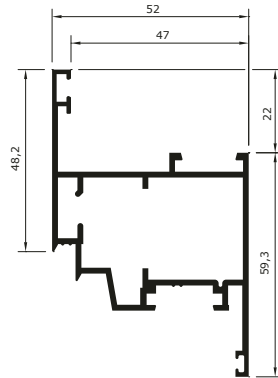

PF43-2390 B LB BLR
(59734)

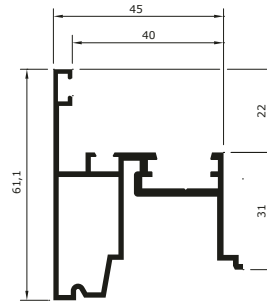

PF40-0100 B LB PM BLR 90 10
(65779)

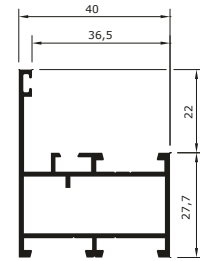

PF40-1160
(65781)

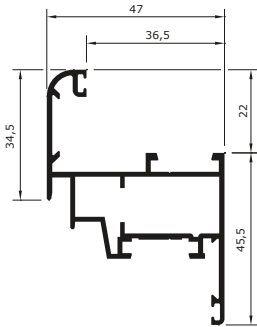

PF40-1190 B LB 90 10
NOVEDAD

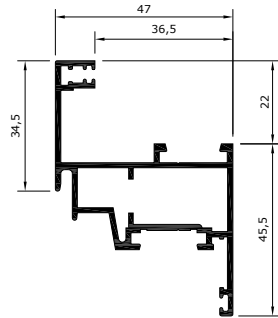

PF40-2360 B LB PM BLR 90 10
(65782)

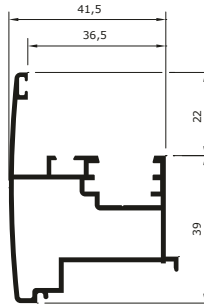

TAPAJUNTAS UNIVERSALES

TP09-0030 B LB
(64537)

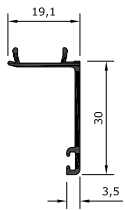

TP09-0040 B LB PM BLR 90 10

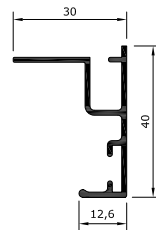

TP09-0060 B LB PM BLR 90 10

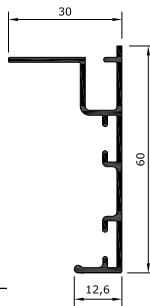

TP09-0085 B LB PM BLR 90 10

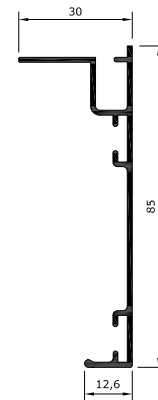

TP06-0040 B LB PM BLR
(64997)

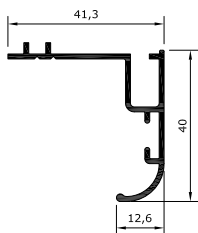

TP06-0085 B LB PM BLR
(64998)

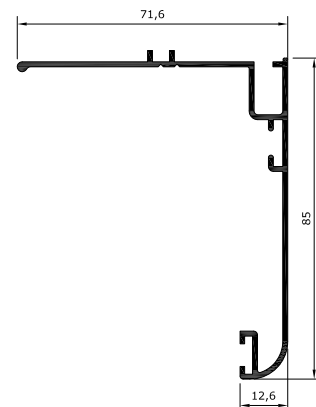













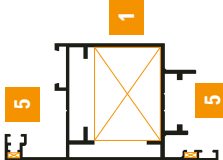



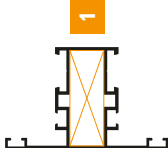

PROVISIONAL 07/10/2024

OF52
7

TABLA DE ASOCIACIONES ENTRE PERFILES Y PRINCIPALES ACCESORIOS

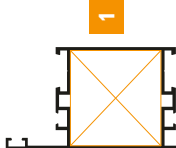
PERFILES		ACCESORIOS RELACIONADOS					UNIONES		TAPAS INVERSORAS Y TERMINACIONES		GOMAS, JUNTAS Y FELPAS	
ESQUEMA	REF	ESCUADRAS Y ELEMENTOS DE TRABAJO	ESCUADRAS ALINEACIÓN	UNIONES	TAPAS INVERSORAS Y TERMINACIONES	GOMAS, JUNTAS Y FELPAS	ESQUEMA	REF	ESQUEMA	REF	ESQUEMA	REF
	OF52-0500	 TPAE-6007 1	 TPAE-7359 5	 TPAE-6007 1	 TPAE-7359 5	 TPAE-6007 1	 TPAE-7359 5	 TPAE-6016 1	 TPAE-7359 5	 TPAE-6016 1	 TPAE-7359 5	 OA52-G900
	OF52-0400	 TPAE-6007 1	 TPAE-7359 5	 TPAE-6007 1	 TPAE-7359 5	 TPAE-6007 1	 TPAE-7359 5	 TPAE-6016 1	 TPAE-7359 5	 TPAE-6016 1	 TPAE-7359 5	 OA52-G900
	OF52-1360	 TPAE-6016 1	 TPAE-7359 5	 TPAE-6016 1	 TPAE-7359 5	 TPAE-6016 1	 TPAE-7359 5	 TPAE-6016 1	 TPAE-7359 5	 TPAE-6016 1	 TPAE-7359 5	 OA52-G900
	OF52-1390	 TPAE-6016 1	 TPAE-7359 5	 TPAE-6016 1	 TPAE-7359 5	 TPAE-6016 1	 TPAE-7359 5	 TPAE-6016 1	 TPAE-7359 5	 TPAE-6016 1	 TPAE-7359 5	 OA52-G900
	OF52-1960	 TPAE-6016 1	 TPAE-7359 5	 TPAE-6016 1	 TPAE-7359 5	 TPAE-6016 1	 TPAE-7359 5	 TPAE-6016 1	 TPAE-7359 5	 TPAE-6016 1	 TPAE-7359 5	 OA52-G900

TABLA DE ASOCIACIONES ENTRE PERFILES Y PRINCIPALES ACCESORIOS

PERFILES		ACCESORIOS RELACIONADOS					GOMAS, JUNTAS Y FELPAS	
ESQUEMA	REF	ESCUADRAS Y ELEMENTOS DE TRABAJO	ESCUADRAS ALINEACIÓN	UNIONES	TAPAS INVERSORAS Y TERMINACIONES	ESQUEMA	REF	
	OF52-1990	 TPAAE-6016 1	 TPAAE-7359 5				 OA52-G900	
	OF52-2360				 OA52-G419 OA52-G492	 CPAG-G5XX		
	PF43-3140	 TPAAE-6006 1		 TPAAE-6144			 CPAG-G5XX	
		 TPAAE-8114 1						
		 TPAAE-8010 1						
		 TPAAE-0393						
	PF43-3340	 TPAAE-6008 1		 TPAAE-6145			 CPAG-G5XX	

OF52
8

TABLA DE ASOCIACIONES ENTRE PERFILES Y PRINCIPALES ACCESORIOS

ACCESORIOS RELACIONADOS













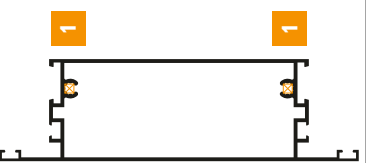

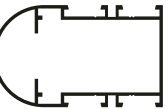



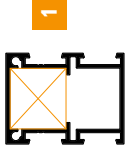



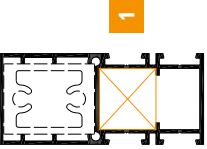





PERFILES	ESCUADRAS Y ELEMENTOS DE TRABAJO		ESCUADRAS ALINEACIÓN		UNIONES		TAPAS INVERSORAS Y TERMINACIONES		GOMAS, JUNTAS Y FELPAS	
	ESQUEMA	REF	ESQUEMA	REF	ESQUEMA	REF	ESQUEMA	REF	ESQUEMA	REF
 <p>OF52-3540</p>		Tornillos auto-rosacantes DIN 7981 4,8x34 1								CPAG-G5XX
	 <p>OF52-3440</p>		Tornillos auto-rosacantes DIN 7981 4,8x34 1							
 <p>OF52-3060</p>						TPAE-6144				
						TPAE-6148				
						TPAE-8144				

TABLA DE ASOCIACIONES ENTRE PERFILES Y PRINCIPALES ACCESORIOS									
PERFILES		ACCESORIOS RELACIONADOS							
ESQUEMA	REF	ESCUADRAS Y ELEMENTOS DE TRABAJO	ESCUADRAS ALINEACIÓN	UNIONES	TAPAS INVERSORAS Y TERMINACIONES	GOMAS, JUNTAS Y FELPAS	ESQUEMA	REF	ESQUEMA
		ESQUEMA	ESQUEMA	ESQUEMA	ESQUEMA	ESQUEMA	ESQUEMA	REF	REF
	OF52-3090								
									
									
	OF52-3099								
									
									
	CP00-9905								
									
									
	CP00-9708								
									
	OF52-0005								

OF52
10



PROVISIONAL 07/10/2024

OF52
11

TABLA DE ASOCIACIONES ENTRE PERFILES Y PRINCIPALES ACCESORIOS

PERFILES		ACCESORIOS RELACIONADOS									
ESQUEMA	REF	ESCUADRAS Y ELEMENTOS DE TRABAJO		ESCUADRAS ALINEACIÓN		UNIONES		TAPAS INVERSORAS Y TERMINACIONES		GOMAS, JUNTAS Y FELPAS	
		ESQUEMA	REF	ESQUEMA	REF	ESQUEMA	REF	ESQUEMA	REF	ESQUEMA	REF
	OF52-0000		TPAE-6007 1		TPAE-7359 5						OA52-G900
	OF52-7098								OA52-G499		CNAP-5007
	OF52-8000		TPAE-6122 1								CNAP-5009

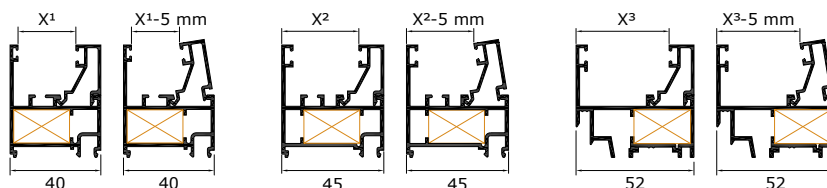

RELACIÓN JUNQUILLO - GROSOR VIDRIO

		JUNQUILLOS										
		36	31	26	21	18	16	11	3			
Opción 1		CP00-9936 (59850)	CP00-9931 (59849)	CP00-9926 (58948)	CP00-9921 (58949)		CP00-9916 (59848)	CP00-9911 (59847)	CP00-9903 (70796)			
	Opción 2		CP00-9936 (59850)	CP00-9736 (5066)	CP00-9926 (58948)	CP00-9726 (5059)	CP00-9921 (58949)	CP00-9721 (5058)	CP00-9916 (59848)	CP00-9716 (5057)	CP00-9911 (59847)	CP00-9711 (5056)
		Opción 3		CP00-9636 (68137)	CP00-9836 (67360)	CP00-9626 (64053)	CP00-9826 (66236)		CP00-9618 (64246)	CP00-9818 (65793)	CP00-9611 (64248)	CP00-9811 (66235)
HUECO MARCOS 40 mm												
X ₁		0,5	5,5	10,5	15,5	18,5	20,5	25,5	33,5			
HUECO HOJAS Y MARCOS 45 mm												
X ₂		4	9	14	19	22	24	29	37			
HUECO HOJAS RECTAS 52 mm												
X ₃		11	16	21	26	29	31	36	44			

OF52
12

ACCESORIOS

ESCUADRAS ENSAMBLE FIJAS

ESQUEMA	REF	DESCRIPCIÓN
	TPAE-6006 (0306)	Escuadra de tiro 25 x 15 mm
	TPAE-6007 (0307)	Escuadra de tiro 25 x 27 mm
	TPAE-6008 (0308)	Escuadra de tiro 25 x 40 mm
	TPAE-6016 (01006)	Escuadra de tiro 40 x 31 mm
	TPAE-6100 (F400)	Escuadra expansión 25 x 15 mm
	TPAE-6103 (F403)	Escuadra expansión 25 x 27 mm
	TPAE-6122 (L81022)	Escuadra para cierre inferior
	TPAE-6190 (F890)	Escuadra de alineación para hojas de apertura exterior RPT

ESCUADRAS ALINEACIÓN

	TPAE-7359 (0359)	Escuadra alineación inox
	TPAE-7306 (0706)	Escuadra alineación inox

UNIONES FIJAS

ESQUEMA	REF	DESCRIPCIÓN
	TPAE-6148 (U408)	Unión 15 x 18 mm extrusión reforzada

UNIONES REGULABLES





	TPAE-8144 (U411)	Unión regulable 15 x 18 mm
	TPAE-8145 (U410)	Unión regulable 40 x 18 mm

TAPAS ESTANQUEIDAD









	OA52-G419 (1909)	Juego tapas para OF52-2360 (5053)
	OA52-G499	Juego tapas para una hoja para perfil OF52-7098 (5064)
	OA52-G492	Juego tapas para puertas de dos hojas para perfil OF52-7098 (5064)

PROVISIONAL 07/10/2024



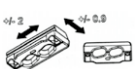
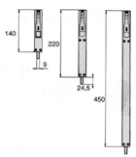





GOMAS Y FELPAS SISTEMA



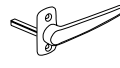
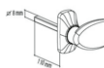

ESQUEMA	REF	DESCRIPCIÓN
	OA52-G900 (G605OP)	Junta estanqueidad Optima
	CNAP-5007 (F5X7)	Felpa 5 x 7 mm
	CPAG-G509 (GA9K)	Goma vidrio 3 m
	CPAG-G510 (GA10K)	Goma vidrio 4 m
	CPAG-G511 (GA11K)	Goma vidrio 6 m
	CPAG-0823 (E0823)	Foam Isolation System 8 x 23 mm
	CNA0-0279	Tapa para perfil de refuerzo TP07-0279
	NA10-0279	Tapa para perfil de refuerzo NT10-0279

BISAGRAS Y PASADORES



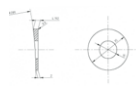

	OA52-5502 (F5502)	Bisagra Optima de dos palas
	OA52-5503 (F5503)	Bisagra Optima de tres palas
	OA52-5409 (F5409)	Pasador Optima 117 mm
	OA52-5410 (F5410)	Pasador Optima 290 mm
	OA52-5411 (F5411)	Prolongador pasador OA54-5410 de 500 mm
	OA52-5415 (F5415)	Encuentro Optima con el pasador
	CPAF-3714 (F3714)	Pasador TITAN 140 mm
	CPAF-3715 (F3715)	Pasador TITAN 220 mm
	CPAF-3716 (F3716)	Pasador TITAN 450 mm
	CPAF-3738 (F3738)	Cerradero cilindrico para el suelo
	CPAF-3734 (F3734)	Placa inox universal para el suelo
	CPAF-3733 (L47025)	Placa para pasadores universales
	CPAF-3740 (F3740)	Cierre para marco

MANILLAS



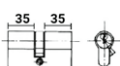

ESQUEMA	REF	DESCRIPCIÓN
	CRAS-2052	Unidad manilla línea CRASH exclusiva Innaltech
	CRAS-2051	Juego manillas línea CRASH exclusiva Innaltech
	CPA0-4900 (4000)	Unidad manilla
	CPA0-4920 (4014)	Unidad manilla con escudo
	CPAF-2051 (F2051)	Juego manillas NEFER
	CPAF-2050 (F2050)	Unidad manilla plana HORUS
	CPAF-2060 (F2060)	Pomo fijo HORUS
	CPAF-2061 (F2061)	Juego de pomos HORUS
	CPAF-2100 (F2100)	Escudo decorativo para bombín
	CPAF-2101 (F2101)	Sistema de seguridad para manilla puerta HORUS y NEFER
	OA52-0024 (H024)	Plantilla para la sujeción de la manilla a puerta Optima elíptica

TIRADORES PARA PUERTA		
	CPA0-3610 (4111)	Juego tiradores AUSTRAL
	CPA0-3610D (4110D)	Unidad tirador AUSTRAL derecha
	CPA0-3610E (4110E)	Unidad tirador AUSTRAL izquierda
	OA52-0025 (H025)	Plantilla sujeción tirador AUSTRAL a puerta Optima elíptica
	CPA0-3900 (4200)	Juego tiradores de 2000 mm
	HOPE-3914	Tirador Hoppe Inox fijación recta de 1400 mm
	HOPE-3916	Tirador Hoppe Inox fijación recta de 1600 mm
	HOPE-3716	Tirador Hoppe Inox fijación inclinada de 1600 mm

CERRADURAS 1 PUNTO ESTÁNDAR PARA CÁMARA OPTIMA

ESQUEMA	REF	DESCRIPCIÓN
	OA52-2017 (P347)	Cerradura 1 punto de golpe y llave con frontal 25 mm
	OA52-2016 (P348)	Cerradura 1 punto de rodillo con frontal 25 mm
	OA52-5412 (F5412)	Contraplaca Cámara Optima 11 mm picaporte y rodillo
	OA52-5413 (F5413)	Contraplaca Cámara Optima grande 14 mm cerradero central
	CPAC-2016 (P351)	Cerradura eléctrica con frontal 25 mm
	CPAC-3535 (P7682)	Bombín de 70 mm 35/35 para OF52-OPTIMA



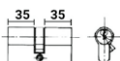

CERRADURAS 3 PUNTOS MULTITOP CISA PARA CÁMARA EUROPEA

	CISA-3037	Cerradura MULTITOP CISA 3 puntos de golpe y llave frontal (forma U)
	CISA-8070	Rodillo para insertar en cerradura CISA
	OA52-8000 (P349)	Contraplaca central para puerta de vaivén y para MULTITOP CISA
	OA52-8005 (P350)	Contraplaca para 2 y 3 puntos para puerta de vaivén y para MULTITOP CISA



CERRADURAS 3 PUNTOS AUTOMÁTICAS GU

	OA52-2035 1	Cerradura automática de 3 puntos GU frontal U
	OA52-8150D 2	Contraplaca continua cerradura automática GU derecha
	OA52-8150E 2	Contraplaca continua cerradura automática GU izquierda
	CPGU-8050 3	Motor para cerradura GU CPAC-2035
	CPAC-8051 (P364) 4	Contactora para cerradura eléctrica
	CPAC-3535 (P7682)	Bombín de 70 mm 35/35 para OF52-OPTIMA

SISTEMAS ANTIPÁNICO

ESQUEMA	REF	DESCRIPCIÓN
	CPAC-8500 (P353)	Kit antipánico PUSH 1 hoja
	CPAC-8501 (P354)	Kit antipánico PUSH para hoja pasiva
	CPA0-4914 (P355)	Manilla condensable con llave exterior
	CPA0-4516 (P358)	Pomo condensable con llave exterior
	CPAC-8502	Kit alargador antipánico 2250 mm

MUELLES PARA PUERTA

	CPA0-M604 (M604)	Muelle aéreo tradicional con retenedor
	CPA0-M605 (M605)	Muelle aéreo de guía deslizante con retenedor
	CPA0-M606 (M606)	Muelle aéreo tradicional para puertas pesadas con retenedor

MUELLE OCULTO

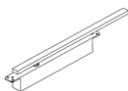
	CPA0-M613D (M613D)	Muelle con retenedor oculto en el perfil derechas
	CPA0-M613E (M613E)	Muelle con retenedor oculto en el perfil izquierdas

SISTEMA MUELLE EN EL SUELO

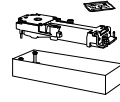
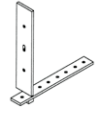
	CPA0-M607 (M607)	Muelle para el suelo
	OA52-M713D (RM1/D)	Kit para el muelle en el suelo CPA0-M607 hojas apertura interior derechas
	OA52-M713E (RM1/E)	Kit para el muelle en el suelo CPA0-M607 hojas apertura interior izquierdas
	OA52-M719D (RM2/D)	Kit para el muelle en el suelo CPA0-M607 hojas apertura exterior derechas
	OA52-M719E (RM2/E)	Kit para el muelle en el suelo CPA0-M607 hojas apertura exterior izquierdas

OF52
14

PROVISIONAL 07/10/2024

SISTEMA MUELLE VAIVÉN

ESQUEMA	REF	DESCRIPCIÓN
	CPA0-M608 (M608)	Muelle para el suelo puerta vaivén con retención
	CPA0-M6085	Muelle para el suelo puerta vaivén sin retención
	OA52-M813D (RM3/D)	Kit refuerzo para muelle vaivén derechas
	OA52-M813E (RM3/E)	Kit refuerzo para muelle vaivén izquierdas
	OA52-8000 (P349)	Contraplaca central para puerta de vaivén y para MULTITOP CISA
	OA52-8005 (P350)	Contraplaca para 2 y 3 puntos para puerta de vaivén y para MULTITOP CISA
	CISA-3037	Cerradura MULTITOP CISA 3 puntos de golpe y llave frontal forma U
	CISA-8070	Rodillo para insertar en cerradura CISA
	CPAC-3535 (P7682)	Bombín de 70 mm 35/35 para OF52-Optima



SISTEMA DE CIERRE INFERIOR OCULTO

	CPA0-M610 (M610)	Cierre guillotina oculto inferior de 700 a 800 mm
	CPA0-M611 (M611)	Cierre guillotina oculto inferior de 800 a 900 mm
	CPA0-M612 (M612)	Cierre guillotina oculto inferior de 900 a 1000 mm

UTENSILIOS ESPECÍFICOS DE FABRICACIÓN

	OA52-0000 (KOP1)	Kit para la fabricación de la puerta Optima elíptica
---	-------------------------	--

GOMAS CUÑA TRADICIONALES

ESQUEMA	REF	DESCRIPCIÓN
	CPAG-G7-1 (CF10P)	Goma de cuña interior
	CPAG-G7-0 (CF10)	Goma de cuña interior para acristalamiento 3 mm
	CPAG-G600	Goma de cuña interior tradicional para acristalamiento 3/3,5 mm
	CPAG-G602	Goma de cuña interior tradicional para acristalamiento 4/4,5 mm
	CPAG-G604	Goma de cuña interior tradicional para acristalamiento 5/5,5 mm
	CPAG-G607	Goma de cuña interior tradicional para acristalamiento 7/7,5 mm
	CPAG-G610	Goma de cuña interior tradicional para acristalamiento 9/9,5 mm

GOMAS CUÑA PRECORTADAS

	CPAG-G700 (CL0K)	Goma de cuña interior precortada para acristalamiento B=3 mm (blanca)
	CPAG-G702 (CL2K)	Goma de cuña interior precortada para acristalamiento B=4 mm (roja)
	CPAG-G704 (CL4K)	Goma de cuña interior precortada para acristalamiento B=5 mm (azul)
	CPAG-G707 (CL7K)	Goma de cuña interior precortada para acristalamiento B=7 mm (verde)
	CPAG-G710 (CL10K)	Goma de cuña interior precortada para acristalamiento B=10 mm (amarilla)

PUERTA DE UNA HOJA APERTURA INTERIOR CON FIJO LATERAL Y BATIENTE SUPERIOR

PF43(A1=102(0));(A2=050(0));OF52(B2=150E(0));0

