

Practicable de cámara europea, con rotura de puente térmico mediante varillas de 14,8 mm. Este sistema es el precursor de toda la gama Practic RPT. Diseñada con la inclusión de los mayores avances tecnológicos y sometida a exigentes tests de calidad, otorga una versatilidad inmejorable. Se puede realizar cualquier tipo de cerramiento, con unas prestaciones elevadas y contrastadas mediante

banco de ensayo. La gran cantidad de opciones disponibles permiten satisfacer las expectativas de los más exigentes. Su variedad permite elegir entre las tradicionales formas redondeadas hasta las rectas más vanguardistas. Equilibrada en todos sus componentes, permite conseguir una inmejorable relación calidad/precio.

Dimensiones base:	Marco:	45 mm
	Hoja:	52 mm
Espesor máximo del cristal:		35 mm

PT45
1

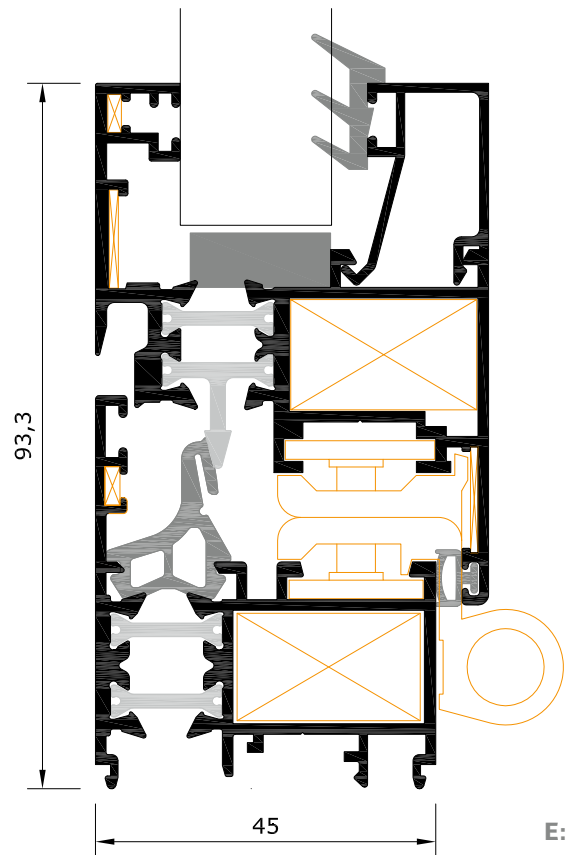

E: 1/1

APERTURAS PRINCIPALES

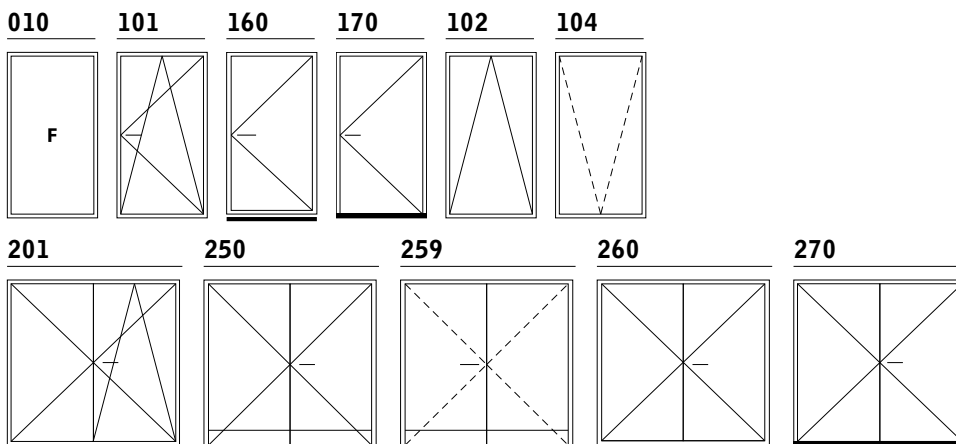

ENSAYOS REALIZADOS AEV

VENTANA	INFORME DE ENSAYO	AIRE	AGUA	VIENTO
820 x 2100 mm 1 hoja oscilobatiente cristal 4/16/4	09/100329-1324 (APPLUS)	4	E1050	C5
1400 x 1500 mm 2 hojas oscilobatiente cristal 4/16/4	09/100329-444 (APPLUS)	4	8A	C4
1600 x 2100 mm 2 hojas oscilobatiente cristal 4/16/4	09/100329-443 (APPLUS)	4	7A	C2
1600 x 2100 mm 2 hojas oscilobatiente + cajón monobloc cristal 4/16/4	10/101179-1413 (APPLUS)	4	8A	C2
2900 x 2300 mm 4 hojas practicables cristal 4/16/4	10/101179-2716 (APPLUS)	4	6A	C1

ENSAYOS ACÚSTICOS

VENTANA	INFORME DE ENSAYO	RESULTADO (dB)
1400 x 1500 mm 2 hojas oscilobatiente cristal 4/16/4	10/101124-38 (APPLUS)	33
1400 x 1500 mm 2 hojas oscilobatiente cristal 3+3/16/6	10/101124-37 (APPLUS)	36

ENSAYOS TÉRMICOS MARCO

	INFORME DE ENSAYO	RESULTADO (W/m²K)
Nudo perimetral	19124-(1) (CIDEMCO)	3,6
Nudo central	Interno	3,6

ENSAYOS TÉRMICOS MARCO FOAM ISOLATION SYSTEM

	INFORME DE ENSAYO	RESULTADO (W/m²K)
Nudo perimetral	Interno	3,2
Nudo central	Interno	3,3

RESULTADO (W/m²K)

ENSAYOS TÉRMICOS VENTANA SEGÚN CTE	4/14/4	4/14/4 BE*	4/16 Ar/4
	(Ug = 2,8)	(Ug = 1,5)	BE** (Ug = 1,1)
Ventana 1 hoja 820 x 2100 mm	2,97	2,12	1,72
Ventana 2 hojas 1400 x 1500 mm	2,99	2,19	1,80
Ventana 2 hojas 1600 x 2100 mm	2,94	2,07	1,69

* Bajo emisivo

** El resultado térmico para cristal ha sido obtenido colocando el Foam Isolation System en hoja

PT45
2

MEDIDAS VENTANA CUBIERTAS POR ENSAYO

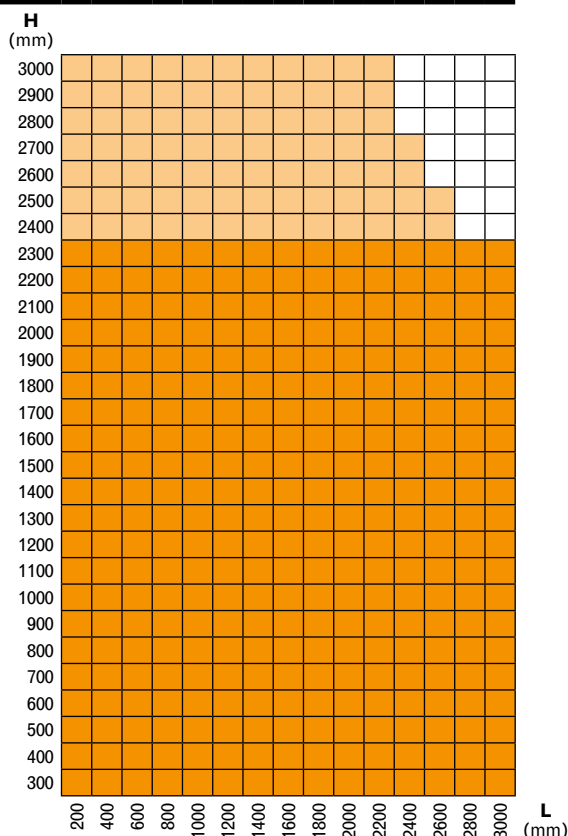

MEDIDAS HOJA NO RECOMENDABLES/NO REALIZABLES

H (mm)	Peso máximo por medida de hoja* (kg)														
	300	400	500	600	700	800	900	1000	1100	1200	1300	1400	1500	1600	1700
2400	110	110	110	110	110	110	110	110	108	105	100	95	90	86	76
2300	110	110	110	110	110	110	110	110	108	105	100	95	90	86	76
2200	110	110	110	110	110	110	110	110	108	105	100	95	90	86	76
2100	110	110	110	110	110	110	110	110	108	105	99	93	88	83	73
2000	110	110	110	110	110	110	110	110	108	104	98	92	87	82	71
1900	110	110	110	110	110	110	110	110	109	101	95	89	84	79	68
1800	110	110	110	110	110	110	110	110	109	101	94	88	83	78	67
1700	110	110	110	110	110	110	110	110	109	101	94	88	83	77	66
1600	110	110	110	110	110	110	110	110	108	100	93	86	81	75	64
1500	110	110	110	110	110	110	110	110	106	99	92	83	78	72	61
1400	98	110	110	110	110	110	110	110	106	99	90	82	77	71	60
1300	86	98	110	110	110	110	110	110	106	99	90	82	76	70	59
1200	73	86	98	110	110	110	110	110	105	98	89	81	75	68	57
1100	61	73	86	98	110	110	110	110	100	97	87	80	68	59	46
1000	55	67	79	92	110	110	110	110	91	88	79	73	60	49	26
900	49	60	73	86	98	110	110	98	86	73	61	49	39	24	
800	43	49	61	67	76	86	79	68	65	53	44	34	22		
700	39	47	53	56	66	75	58	62	52	44	33	15			
600	34	40	45	48	56	62	46	51	40	24					
500	29	34	38	40	47	49	36	33							

- Cubierto ensayos permeabilidad al aire y estanqueidad al agua
- Cubierto ensayos permeabilidad al aire, estanqueidad al agua y resistencia a la carga de viento

- Medidas no recomendables
- Medidas no realizables

* Peso máximo recomendado con herraje oscilobatiente más desfavorable

MARCOS

PT45-0411 B

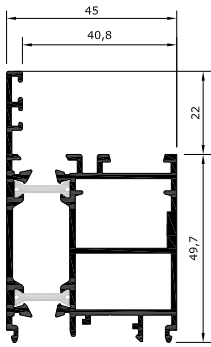

PT45-0110 B LB

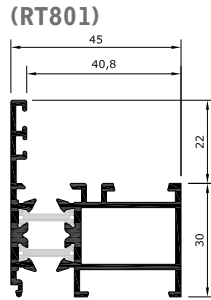

PT45-0111 B LB

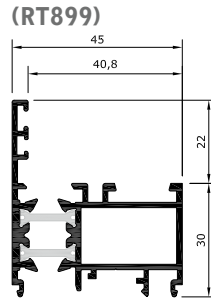

PT45-0112 B

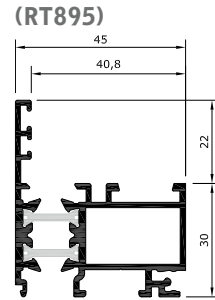

PT45-0120 B

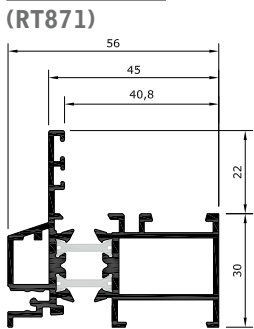

PT45-0121 B

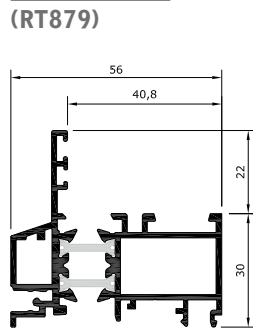

PT45-0122 B

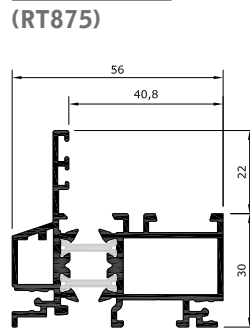

PT45-0216 B

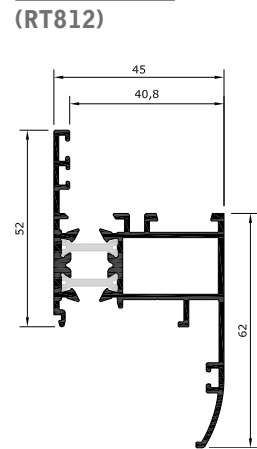

PT45-0219 B

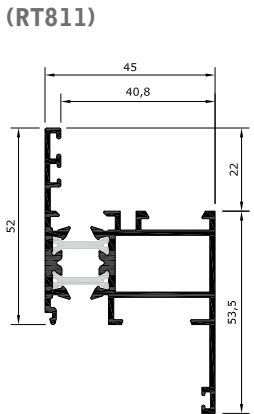

PT45-0226 B

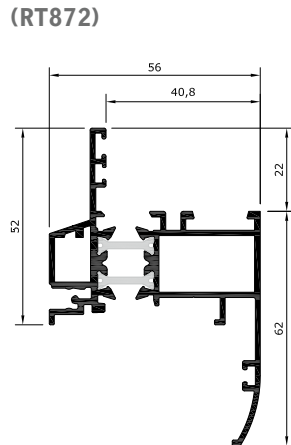

PT45-0229 B

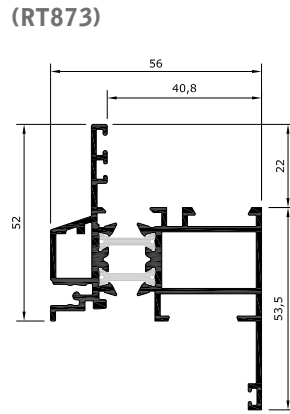

PT45-0301 B LB

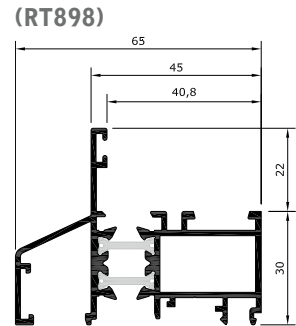

PT45-0311 B LB

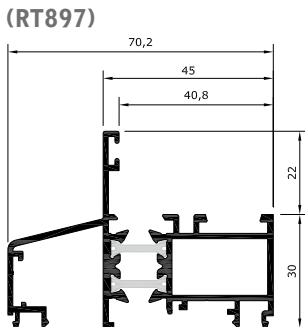

PT45-0302 B

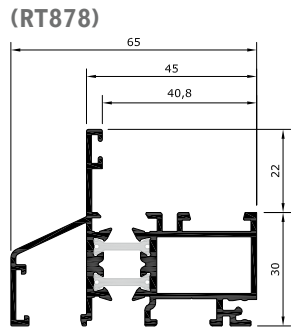

PT45-0312 B

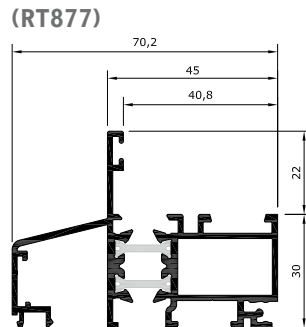

PT45
3

HOJAS APERTURA INTERIOR

PT45-1170 B LB
 (RT826)

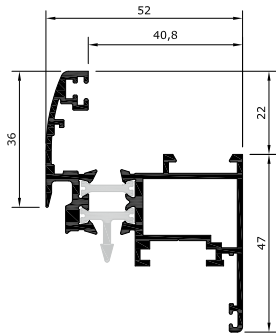

PT45-1190 B LB
 (RT825)

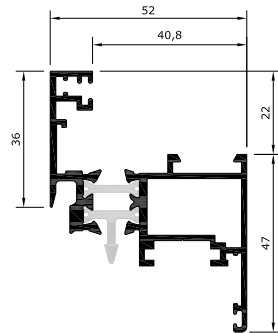

PT45-1477 B LB
 (RT832)

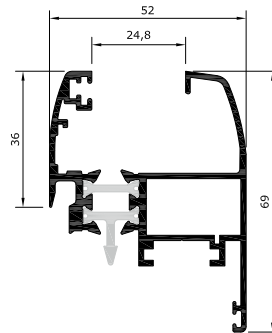

HOJA APERTURA EXTERIOR

PT45-1360 B LB
 (RT024)

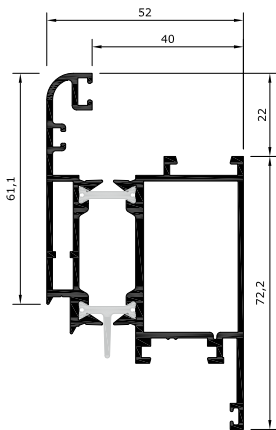

PT45-1390 B LB
 (RT824)

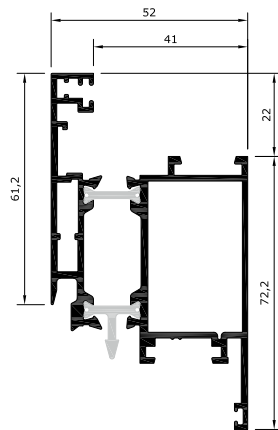

PT45-1990 B LB
 (RT890)

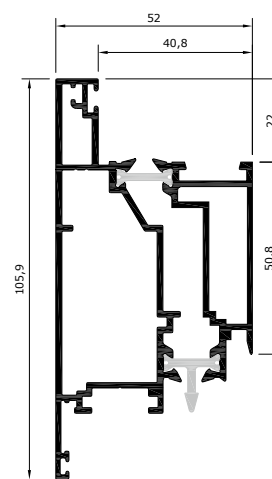

PT45
 4

PERFILES ESTRUCTURALES (MONTANTES, TRAVESAÑOS Y ZÓCALOS)

PT45-3140 B LB
 (RT815)

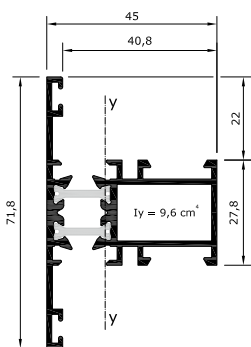

PT45-3340 B LB
 (RT808)

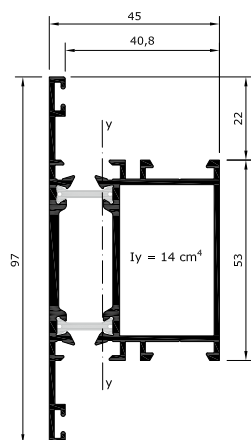

PT45-3240 B
 (RT807)

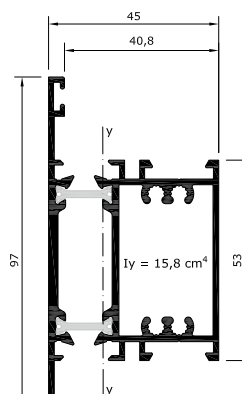

PT45-3440 B

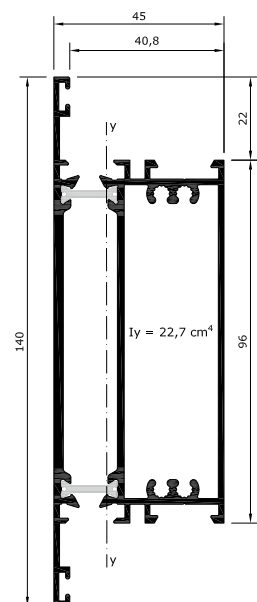

**INVERSOR
PARA PT45-1360**

INVERSOR

PT45-2390 **B** **LB**
(RT823)

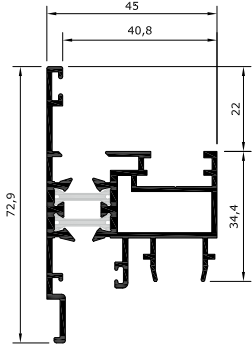

AT45-2390 **B** **LB**
(RT023)

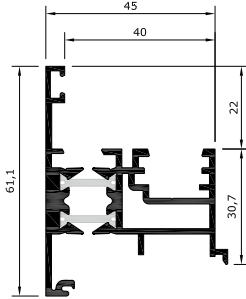

PT45
5

PERFILES ESTRUCTURALES DE REFUERZO UNIVERSALES

TP07-0279 **B**

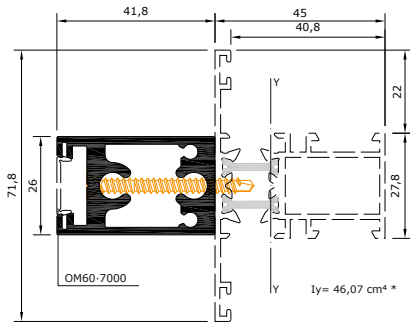

NT10-0279 **B**
NOVEDAD

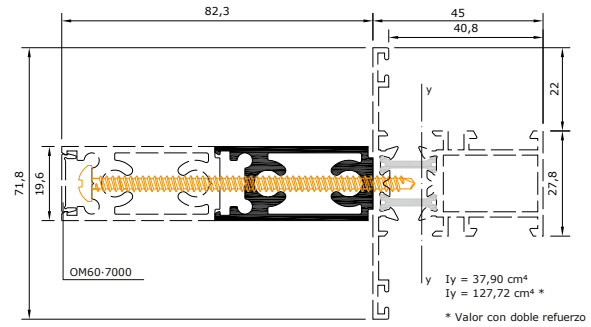

TAPÉES

TE29-0047 **B**
(L8114)

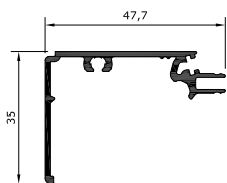

TE29-0067 **B**
(L8117)

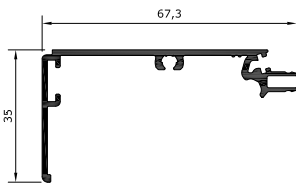

TE29-0042 **B**
(L8116)

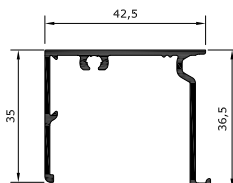

PERFILES AIREADORES

GP07-3693 **B**

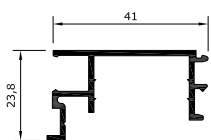

GPM7-3693 **B** **LB**
mecanizado

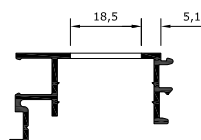



PERFILES PARA CIERRE BAJO PUERTA

PT45-7098 B LB

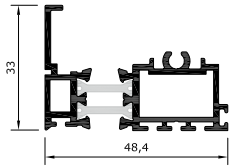

PT45-0830 PM

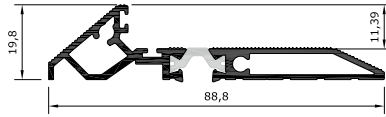

PT45-0800 PM



TE07-0023

B LB PM BLR 90 10

(62020)

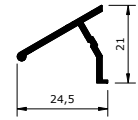

PERFILES PORTICÓN

CP00-9900 B LB

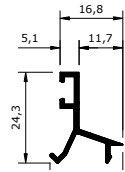

XX06-0016 B LB

(65916)

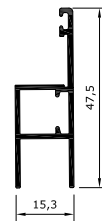

OB30-2390 B LB

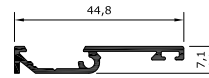

OM60-7000 B LB PM BLR

(2131)

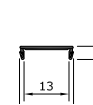

XX09-7992 B LB BLR

(7992)

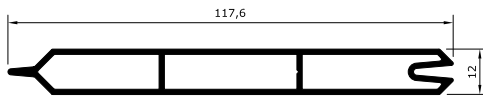

XX09-0195 B

NOVEDAD

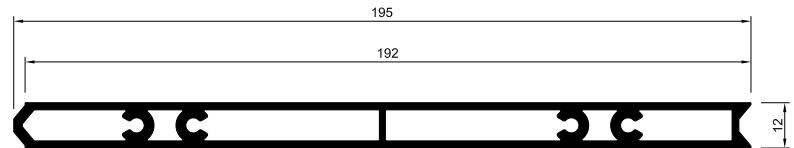

PT45
6

POSIBILIDADES DE UNIONES ENTRE SÉRIES MEDIANTE LAS DISTINTAS COMBINACIONES DE PERFILES TP01-0022, TP01-0023 Y TP06-4760

TP01-0022 B LB PM BLR 90 10
(10022)

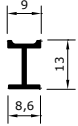

TP01-0023 B LB PM BLR 90 10
NOVEDAD

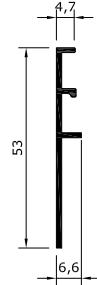

TP06-4760 B LB PM BLR 90 10
(64760)

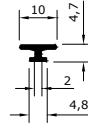

PT45
7

NT71-5911 + PT45-0111

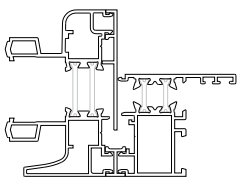

NT71-5611 + PT45-0111

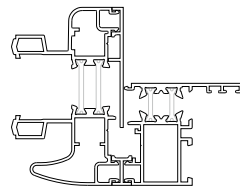

NT71-5511 + PT45-0111

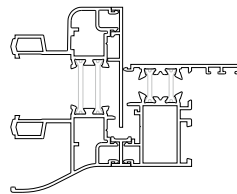

NT71-5811 + PT45-0111

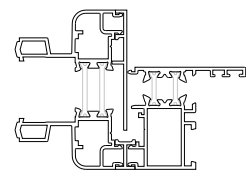

NT71-5701 + PT45-0111

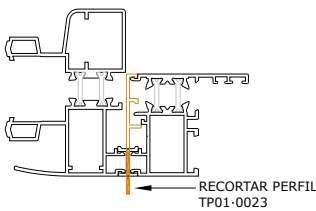

NT95-5911 + PT45-0111

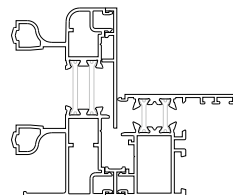

NT95-5601 + PT45-0111

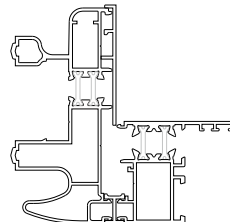

NT95-4911 + PT45-0111

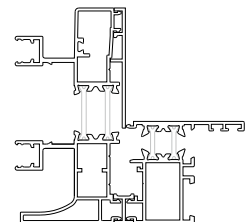

NT95-4811 + PT45-0111

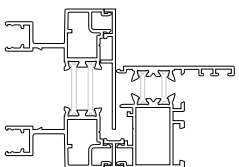

NT95-4311 + PT45-0111

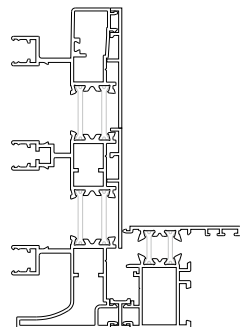

NT95-4411 + PT45-0111

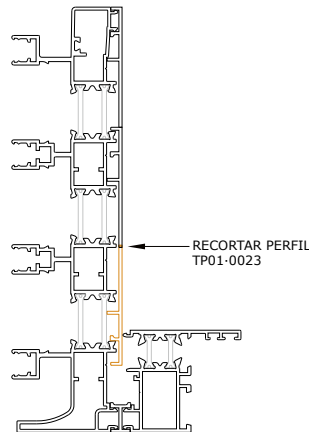

NT10-4811 + PT45-0111

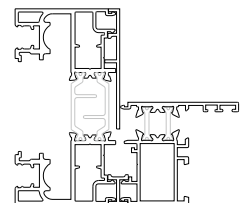



NT10-4311 + PT45-0111

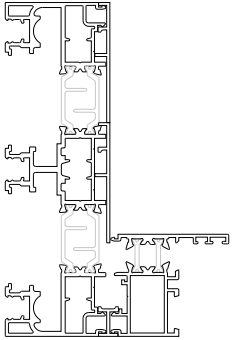

NT10-4411 + PT45-0111

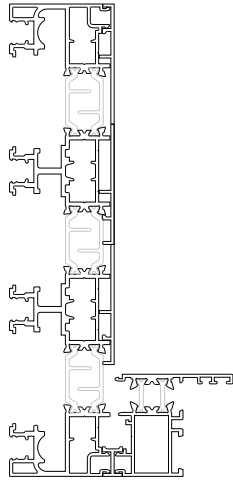

NT11-4811 + PT45-0111

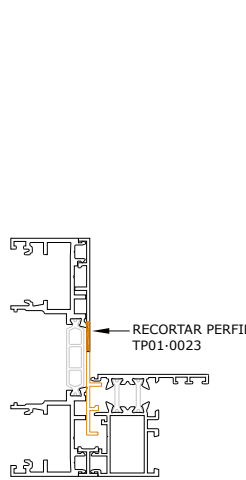

NT11-4311 + PT45-0111

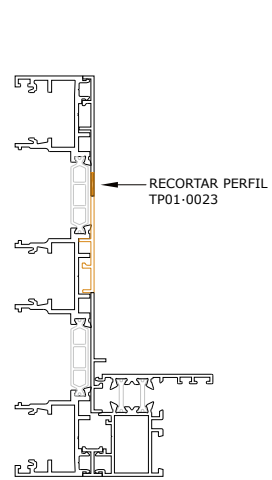

NT71-5911 + PT45-0411

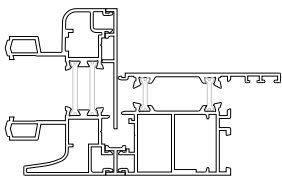

NT71-5611 + PT45-0411

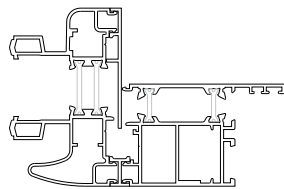

NT71-5511 + PT45-0411

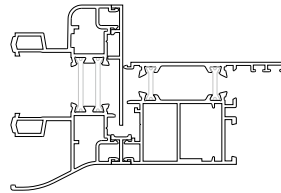

NT71-5811 + PT45-0411

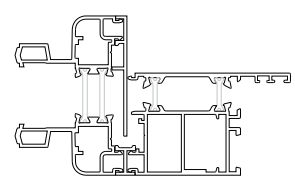

NT71-5701 + PT45-0411

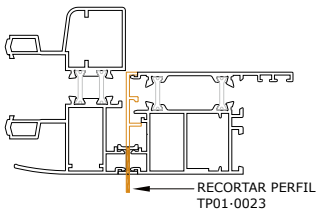

NT95-5911 + PT45-0411

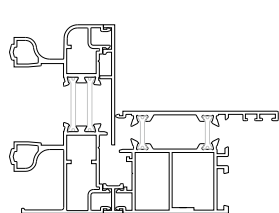

NT95-5601 + PT45-0411

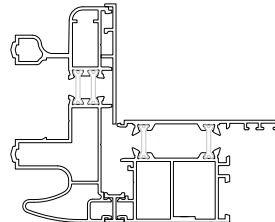

NT95-4911 + PT45-0411

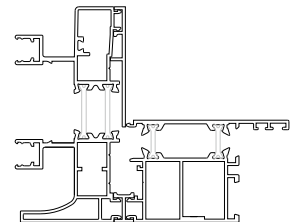

NT95-4811 + PT45-0411

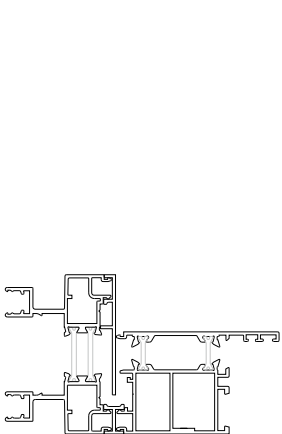

NT95-4311 + PT45-0411

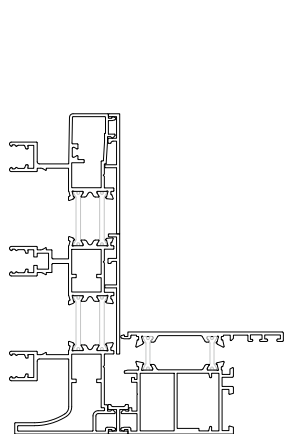

NT95-4411 + PT45-0411

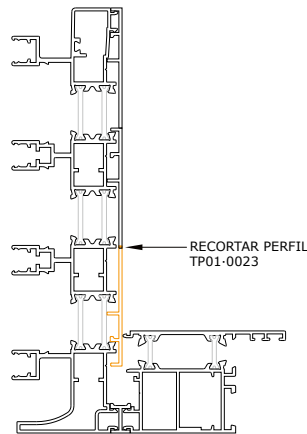

NT10-4811 + PT45-0411

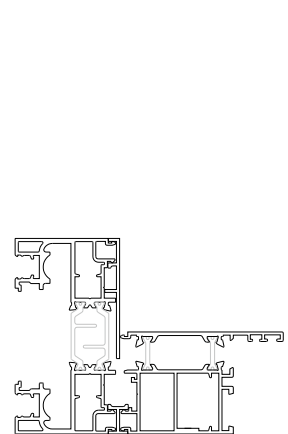

NT10-4311 + PT45-0411

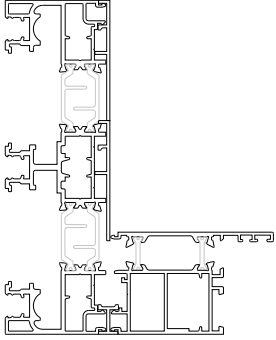

NT10-4411 + PT45-0411

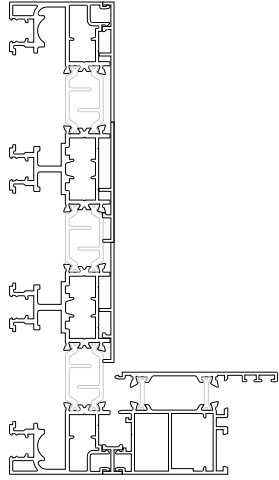

NT11-4811 + PT45-0411

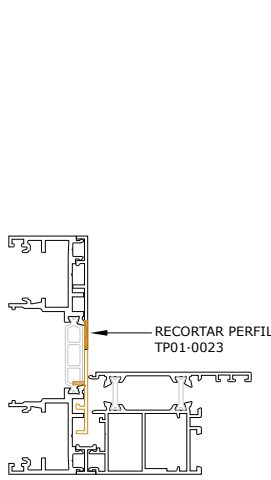

NT11-4311 + PT45-0411

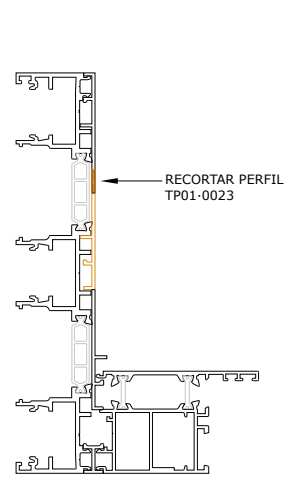

NT71-5911 + PT45-0311

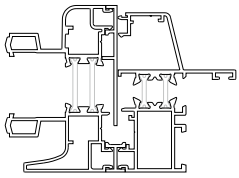

NT71-5611 + PT45-0311

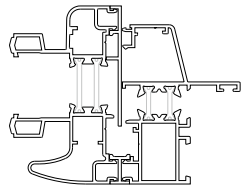

NT71-5511 + PT45-0311

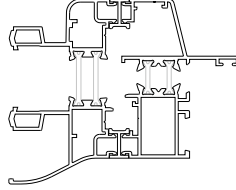

NT71-5811 + PT45-0311

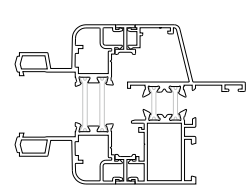

PT45
9

NT71-5701 + PT45-0311

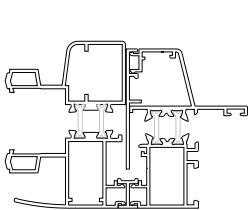

NT95-5911 + PT45-0311

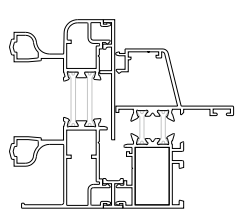

NT95-5601 + PT45-0311

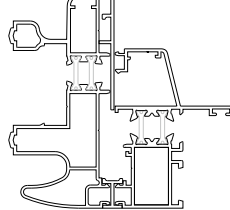

NT95-4911 + PT45-0311

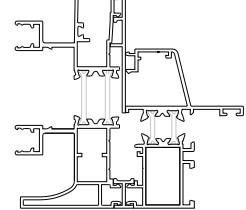

NT95-4811 + PT45-0311

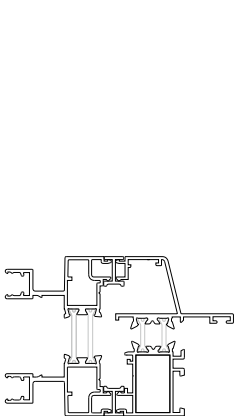

NT95-4311 + PT45-0311

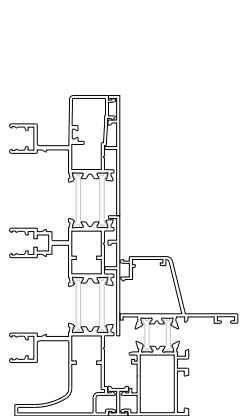

NT95-4411 + PT45-0311

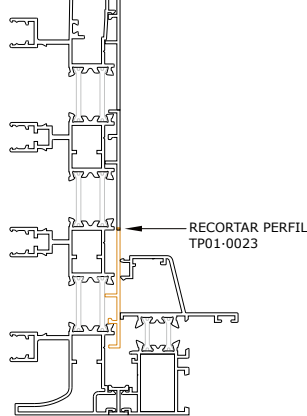

NT10-4811 + PT45-0311

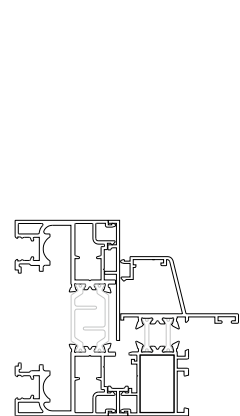



NT10-4311 + PT45-0311

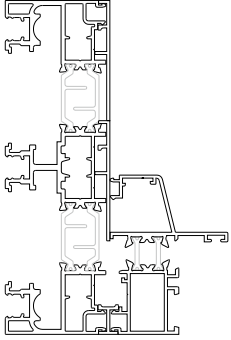

NT71-5911 + PT45-0301

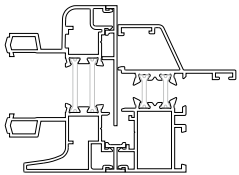

NT71-5701 + PT45-0301

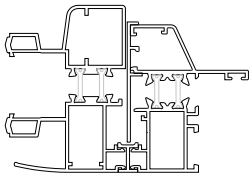

NT95-4811 + PT45-0301

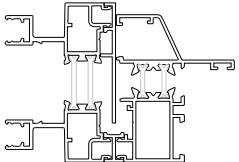

NT10-4411 + PT45-0311

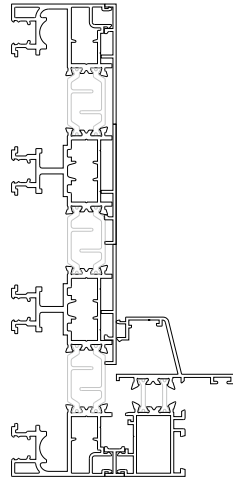

NT71-5611 + PT45-0301

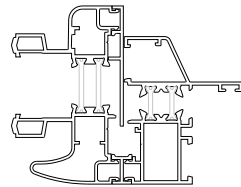

NT95-5911 + PT45-0301

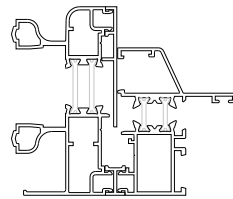

NT95-4311 + PT45-0301

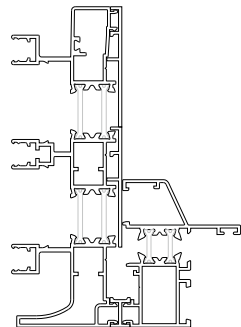

NT11-4811 + PT45-0311

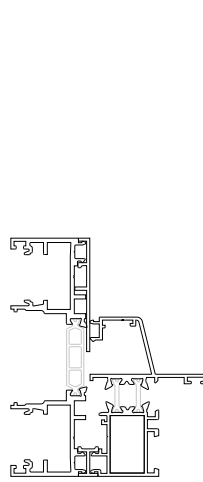

NT71-5511 + PT45-0301

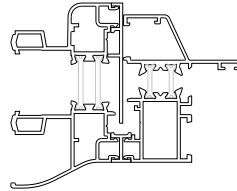

NT95-5601 + PT45-0301

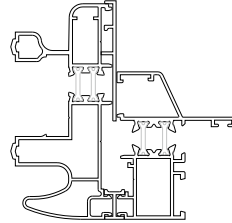

NT95-4411 + PT45-0301

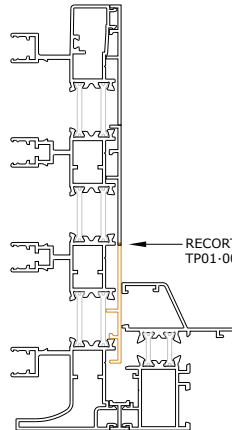

NT11-4311 + PT45-0311

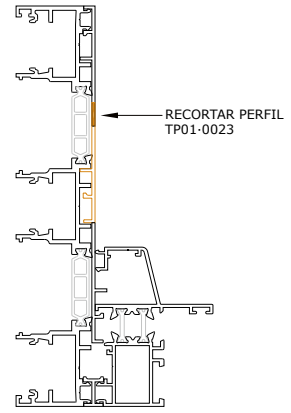

NT71-5811 + PT45-0301

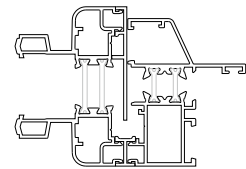

NT95-4911 + PT45-0301

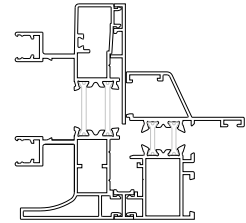

NT10-4811 + PT45-0301

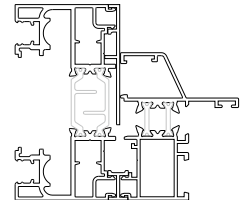

NT10-4311 + PT45-0301

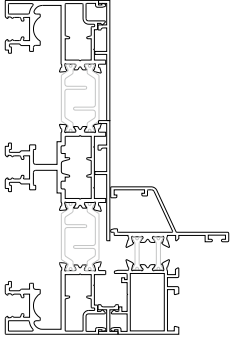

NT10-4411 + PT45-0301

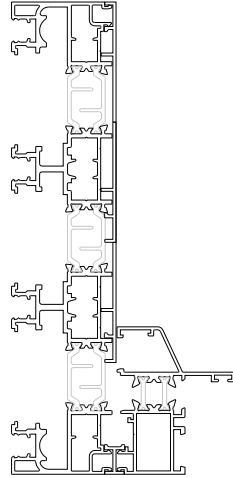

NT11-4811 + PT45-0301

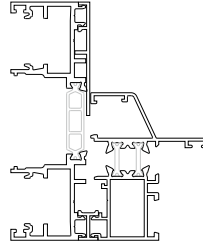

NT11-4311 + PT45-0301

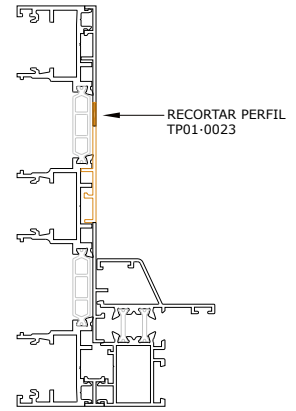

PT45
11

UTILIZACIÓN DEL PERFIL TP01-0023 COMO REMATE DE MARCO

PT45-0111 + TP01-0023

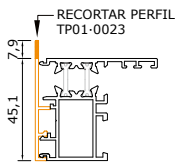

PT45-0411 + TP01-0023

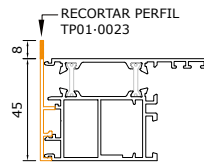

PT45-0311 + TP01-0023

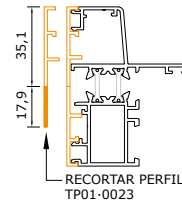

CAPÍTULO 4.1.20
PRACTICABLES PRACTIC 45 RPT · PT45
TABLA DE ASOCIACIONES ENTRE PERFILES
Y PRINCIPALES ACCESORIOS

TABLA DE ASOCIACIONES ENTRE PERFILES Y PRINCIPALES ACCESORIOS
 ACCESORIOS RELACIONADOS

PERFILES		ESCUADRAS Y ELEMENTOS DE TRABAJO			ESCUADRAS ALINEACIÓN		UNIONES		TAPAS INVERSORAS Y TERMINACIONES		GOMAS, JUNTAS Y FELPAS		
ESQUEMA	REF	ESQUEMA	REF	ESQUEMA	REF	ESQUEMA	REF	ESQUEMA	REF	ESQUEMA	REF	ESQUEMA	REF
	PT45-0411		TPAE-6006		TPAE-7359		TPAE-0393						PA 45-G100
			TPAE-8114										
			TPAE-8010										
			TPAE-6193										
	PT45-0110		TPAE-6006		TPAE-7359		TPAE-6144						PA 45-G100
			TPAE-8114										
			TPAE-8010										
	PT45-0111		TPAE-6006		TPAE-7359		TPAE-0393						PA 45-G100
			TPAE-8114										
			TPAE-8010										

PT45
12



PROVISIONAL 24/10/2023

PT45
13

TABLA DE ASOCIACIONES ENTRE PERFILES Y PRINCIPALES ACCESORIOS

ACCESORIOS RELACIONADOS











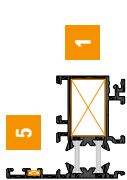











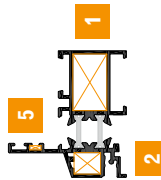











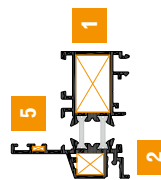









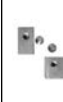

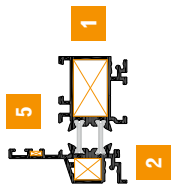















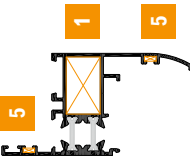











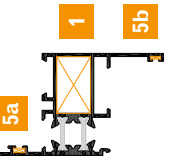

PERFILES	ESCUADRAS Y ELEMENTOS DE TRABAJO	ESCUADRAS ALINEACIÓN		UNIONES		TAPAS INVERSORAS Y TERMINACIONES		GOMAS, JUNTAS Y FELPAS	
		ESQUEMA	REF	ESQUEMA	REF	ESQUEMA	REF	ESQUEMA	REF
 <p>PT45-0112</p>	 <p>TPAE-6006 1</p>	 <p>TPAE-7359 5</p>	 <p>TPAE-0393</p>	 <p>TPAE-6140</p>					<p>PA 45-G100</p>
	 <p>TPAE-8114 1</p>								
	 <p>TPAE-8010 1</p>								
	 <p>TPAE-6006 1</p>								
 <p>PT45-0120</p>	 <p>TPAE-8114 1</p>	 <p>TPAE-7359 5</p>	 <p>TPAE-0393</p>	 <p>HA70-0393</p>					<p>PA 45-G100</p>
	 <p>TPAE-8010 1</p>								
	 <p>TPAE-6078 2</p>			 <p>TPAE-6140</p>					
	 <p>TPAE-6006 1</p>								
 <p>PT45-0121</p>	 <p>TPAE-8114 1</p>	 <p>TPAE-7359 5</p>	 <p>TPAE-0393</p>	 <p>HA70-0393</p>					<p>PA 45-G100</p>
	 <p>TPAE-8010 1</p>								
	 <p>TPAE-6078 2</p>			 <p>TPAE-6140</p>					
	 <p>TPAE-6006 1</p>								

TABLA DE ASOCIACIONES ENTRE PERFILES Y PRINCIPALES ACCESORIOS
 ACCESORIOS RELACIONADOS

PERFILES	ESCUADRAS Y ELEMENTOS DE TRABAJO			ESCUADRAS ALINEACIÓN		UNIONES		TAPAS INVERSORAS Y TERMINACIONES		GOMAS, JUNTAS Y FELPAS	
	ESQUEMA	REF	ESQUEMA	REF	ESQUEMA	REF	ESQUEMA	REF	ESQUEMA	REF	
 <p>PF45-0122</p>		TPAE-6006 1		TPAE-8114 1	 TPAE-7359 5		 TPAE-0393 HA70-0393 TPAE-6140 PA45-G100 PA45-G000 CPAG-G5XX	 TPAE-0393 HA70-0393 TPAE-6140 PA45-G100 PA45-G000 CPAG-G5XX	 TPAE-0393 HA70-0393 TPAE-6140 PA45-G100 PA45-G000 CPAG-G5XX	 TPAE-0393 HA70-0393 TPAE-6140 PA45-G100 PA45-G000 CPAG-G5XX	 TPAE-0393 HA70-0393 TPAE-6140 PA45-G100 PA45-G000 CPAG-G5XX
		TPAE-8010 1		TPAE-6078 2							
		TPAE-6006 1		TPAE-8114 1							
		TPAE-8010 1		TPAE-6006 1							
 <p>PT45-0216</p>		TPAE-6006 1		TPAE-8114 1	 TPAE-7359 5		 TPAE-0393 HA70-0393 TPAE-6140 PA45-G100 PA45-G000 CPAG-G5XX	 TPAE-0393 HA70-0393 TPAE-6140 PA45-G100 PA45-G000 CPAG-G5XX	 TPAE-0393 HA70-0393 TPAE-6140 PA45-G100 PA45-G000 CPAG-G5XX	 TPAE-0393 HA70-0393 TPAE-6140 PA45-G100 PA45-G000 CPAG-G5XX	 TPAE-0393 HA70-0393 TPAE-6140 PA45-G100 PA45-G000 CPAG-G5XX
		TPAE-8010 1		TPAE-6006 1							
		TPAE-8114 1		TPAE-7365 5b							
 <p>PT45-0219</p>		TPAE-6006 1		TPAE-8114 1	 TPAE-7359 5a		 TPAE-0393 HA70-0393 TPAE-6140 PA45-G100 PA45-G000 CPAG-G5XX	 TPAE-0393 HA70-0393 TPAE-6140 PA45-G100 PA45-G000 CPAG-G5XX	 TPAE-0393 HA70-0393 TPAE-6140 PA45-G100 PA45-G000 CPAG-G5XX	 TPAE-0393 HA70-0393 TPAE-6140 PA45-G100 PA45-G000 CPAG-G5XX	
		TPAE-8010 1		TPAE-7365 5b							



PROVISIONAL 24/10/2023

PT45
15

TABLA DE ASOCIACIONES ENTRE PERFILES Y PRINCIPALES ACCESORIOS
ACCESORIOS RELACIONADOS

PERFILES	ESCUADRAS Y ELEMENTOS DE TRABAJO				ESCUADRAS ALINEACIÓN		UNIONES		TAPAS INVERSORAS Y TERMINACIONES		GOMAS, JUNTAS Y FELPAS	
	ESQUEMA	REF	ESQUEMA	REF	ESQUEMA	REF	ESQUEMA	REF	ESQUEMA	REF	ESQUEMA	REF
<p>PT45-0226</p>		TPAE-6006 1		TPAE-7359 5		TPAE-0393		PA45-G100				
		TPAE-8114 1		TPAE-7365 5a		HA70-0393		PA45-G000				
		TPAE-8010 1		TPAE-7365 5b		TPAE-6140		CPAG-G5XX				
		TPAE-6078 2										
<p>PT45-0229</p>		TPAE-6006 1		TPAE-7359 5a		TPAE-0393		PA45-G100				
		TPAE-8114 1		TPAE-7365 5b		HA70-0393		PA45-G000				
		TPAE-8010 1						CPAG-G5XX				
		TPAE-6078 2										
<p>PT45-0301</p>		TPAE-6006 1				TPAE-0393		PA45-G100				
		TPAE-8114 1				TPAE-6140		PA45-G000				
		TPAE-8010 1						CPAG-G5XX				
		TPAE-7013 2										

TABLA DE ASOCIACIONES ENTRE PERFILES Y PRINCIPALES ACCESORIOS

ACCESORIOS RELACIONADOS

























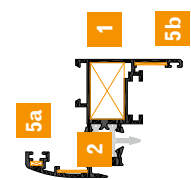







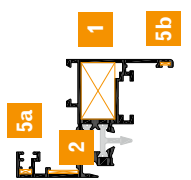



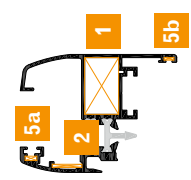

PERFILES		ESCUADRAS Y ELEMENTOS DE TRABAJO				ESCUADRAS ALINEACIÓN		UNIONES		TAPAS INVERSORAS Y TERMINACIONES		GOMAS, JUNTAS Y FELPAS		
ESQUEMA	REF	ESQUEMA	REF	ESQUEMA	REF	ESQUEMA	REF	ESQUEMA	REF	ESQUEMA	REF	ESQUEMA	REF	
	PT45-0311		TPAE-6006		TPAE-8114		TPAE-8010		TPAE-0393		TPAE-6140		PA45-G100	
			TPAE-8114		TPAE-8010		TPAE-0393		TPAE-6140		PA45-G000	PA45-G000		PA45-G000
			TPAE-8010		TPAE-7013		TPAE-0393		TPAE-6140		CPAG-G5XX	CPAG-G5XX		CPAG-G5XX
			TPAE-7013		TPAE-6006		TPAE-8114		TPAE-8010		TPAE-0393		TPAE-6140	
	PT45-0302		TPAE-6006		TPAE-8114		TPAE-8010		TPAE-0393		TPAE-6140		PA45-G100	
			TPAE-8114		TPAE-8010		TPAE-0393		TPAE-6140		PA45-G000	PA45-G000		PA45-G000
			TPAE-8010		TPAE-7013		TPAE-0393		TPAE-6140		CPAG-G5XX	CPAG-G5XX		CPAG-G5XX
			TPAE-7013		TPAE-6006		TPAE-8114		TPAE-8010		TPAE-0393		TPAE-6140	
	PT45-0312		TPAE-6006		TPAE-8114		TPAE-8010		TPAE-0393		TPAE-6140		PA45-G100	
			TPAE-8114		TPAE-8010		TPAE-0393		TPAE-6140		PA45-G000	PA45-G000		PA45-G000
			TPAE-8010		TPAE-7013		TPAE-0393		TPAE-6140		CPAG-G5XX	CPAG-G5XX		CPAG-G5XX
			TPAE-7013		TPAE-6006		TPAE-8114		TPAE-8010		TPAE-0393		TPAE-6140	

TABLA DE ASOCIACIONES ENTRE PERFILES Y PRINCIPALES ACCESORIOS
ACCESORIOS RELACIONADOS

PERFILES	ESCUADRAS Y ELEMENTOS DE TRABAJO				ESCUADRAS ALINEACIÓN		UNIONES		TAPAS INVERSORAS Y TERMINACIONES		GOMAS, JUNTAS Y FELPAS	
	ESQUEMA	REF	ESQUEMA	REF	ESQUEMA	REF	ESQUEMA	REF	ESQUEMA	REF	ESQUEMA	REF
	PT45-1170		TPAE-6006		TPAE-7359							CPAG-G900
			TPAE-8114		TPAE-7310							
			TPAE-8010									
			TPAE-7013									
	PT45-1190		TPAE-6006		TPAE-7359							CPAG-G900
			TPAE-8114		TPAE-7310							
			TPAE-8010									
			TPAE-7013									
	PT45-1477		TPAE-6006		TPAE-7359							CPAG-G900
			TPAE-8114		TPAE-7365							
			TPAE-8010									
			TPAE-7013									

CAPÍTULO 4.1.20
PRACTICABLES PRACTIC 45 RPT · PT45
TABLA DE ASOCIACIONES ENTRE PERFILES
Y PRINCIPALES ACCESORIOS

TABLA DE ASOCIACIONES ENTRE PERFILES Y PRINCIPALES ACCESORIOS

ACCESORIOS RELACIONADOS











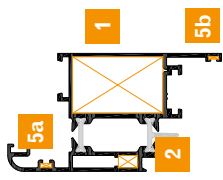





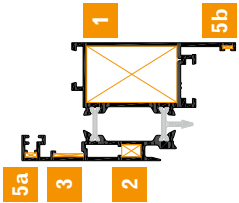







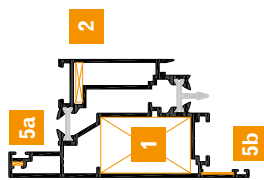





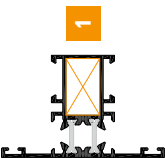

























PERFILES	ESCUADRAS Y ELEMENTOS DE TRABAJO		ESCUADRAS ALINEACIÓN		UNIONES		TAPAS INVERSORAS Y TERMINACIONES		GOMAS, JUNTAS Y FELPAS	
	ESQUEMA	REF	ESQUEMA	REF	ESQUEMA	REF	ESQUEMA	REF	ESQUEMA	REF
 PT45-1360		TPAE-6008 1		TPAE-7359 5a				CPAG-G900		
		TPAE-7360 2		TPAE-7365 5b					CPAG-G907	
 PF45-1390		TPAE-6008 1		TPAE-7359 5a				CPAG-G900		
		TPAE-7360 2		TPAE-7365 5b				CPAG-G907		
		TPAE-7013 3							CPAG-G5XX	
 PT45-1990		TPAE-6008 1		TPAE-7359 5a				CPAG-G900		
		TPAE-6190 2		TPAE-7310 5b				CPAG-G907		

TABLA DE ASOCIACIONES ENTRE PERFILES Y PRINCIPALES ACCESORIOS
ACCESORIOS RELACIONADOS

PERFILES	ESCUADRAS Y ELEMENTOS DE TRABAJO		ESCUADRAS ALINEACIÓN		UNIONES		TAPAS INVERSORAS Y TERMINACIONES		GOMAS, JUNTAS Y FELPAS																			
	ESQUEMA	REF	ESQUEMA	REF	ESQUEMA	REF	ESQUEMA	REF	ESQUEMA	REF																		
 PT45-3140	 TPAE-6006 1	 TPAE-8114 1	 TPAE-8010 1	 TPAE-6144	 TPAE-6148	 TPAE-8144	 TPAE-0393	 TPAE-6145	 TPAE-8145	 PA45-G100	 PA45-G000	 CPAG-G5XX																
													 TPAE-6008 1	 TPAE-6145	 TPAE-8145	 TPAE-6145	 TPAE-8145	 PA45-G100	 PA45-G000	 CPAG-G5XX								
																					 TPAE-6008 1	 TPAE-6145	 TPAE-8145	 TPAE-6145	 TPAE-8145	 PA45-G100	 PA45-G000	 CPAG-G5XX
 TPAE-6008 1	 TPAE-6145	 TPAE-8145	 TPAE-6145	 TPAE-8145	 PA45-G100	 PA45-G000	 CPAG-G5XX																					











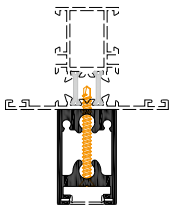

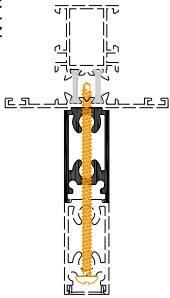





CAPÍTULO 4.1.20
PRACTICABLES PRACTIC 45 RPT · PT45
TABLA DE ASOCIACIONES ENTRE PERFILES
Y PRINCIPALES ACCESORIOS

TABLA DE ASOCIACIONES ENTRE PERFILES Y PRINCIPALES ACCESORIOS ACCESORIOS RELACIONADOS											
PERFILES	ESCUADRAS Y ELEMENTOS DE TRABAJO		ESCUADRAS ALINEACIÓN		UNIONES		TAPAS INVERSORAS Y TERMINACIONES		GOMAS, JUNTAS Y FELPAS		
	ESQUEMA	REF	ESQUEMA	REF	ESQUEMA	REF	ESQUEMA	REF	ESQUEMA	REF	
	PT45-3440					Tornillos autorroscantes DIN 7981 4,8x34				PA45-G100	
	PT45-2390							PA45-G419		PA45-G000	
	AT45-2390							PA45-G492		CPAG-G900	
	PT45-7098							AA45-G419		PA45-G100	
	PT45-0830		TPAE-6140					PA45-G499		CPAG-G906	
	PT45-0800							PA45-G493		CNAP-5009	
	PT45-0800							PA45-G494		CPAG-G906	

TABLA DE ASOCIACIONES ENTRE PERFILES Y PRINCIPALES ACCESORIOS

ACCESORIOS RELACIONADOS

PERFILES	ESCUADRAS Y ELEMENTOS DE TRABAJO		ESCUADRAS ALINEACIÓN		UNIONES		TAPAS INVERSoras Y TERMINACIONES		GOMAS, JUNTAS Y FELPAS	
	ESQUEMA	REF	ESQUEMA	REF	ESQUEMA	REF	ESQUEMA	REF	ESQUEMA	REF
	TP07-0279							CNA0-0279		
	NT10-0279							NA10-0279		
	TE07-0023							CNA0-0023		
	XX06-0016	 TPAE-6078 1								OA60-G905
	OB30-2390	 TPAE-7310 1						OA30-G419		CPAG-G900
	GP07-3693									CPAG-G906
	GPW7-3693							TPA0-3693		

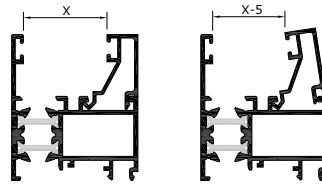

RELACIÓN JUNQUILLO - GROSOR VIDRIO

		JUNQUILLOS										
		36	31	26	21	18	16	11	3			
Opción 1		CP00-9936 (59850)	CP00-9931 (59849)	CP00-9926 (58948)	CP00-9921 (58949)		CP00-9916 (59848)	CP00-9911 (59847)	CP00-9903 (70796)			
Opción 2		CP00-9936 (59850)	CP00-9736 (5066)	CP00-9926 (58948)	CP00-9726 (5059)	CP00-9921 (58949)	CP00-9721 (5058)	CP00-9916 (59848)	CP00-9716 (5057)	CP00-9911 (59847)	CP00-9711 (5056)	
Opción 3		CP00-9636 (68137)	CP00-9836 (67360)	CP00-9626 (64053)	CP00-9826 (66236)			CP00-9618 (64246)	CP00-9818 (65793)		CP00-9611 (64248)	CP00-9811 (66235)
		HUECO (mm)										
X:		4,8	9,8	14,8	19,8	22,8	24,8	29,8	37,8			

PT45
22

ACCESORIOS

ESCUADRAS ENSAMBLE FIJAS

ESQUEMA	REF	DESCRIPCIÓN
	TPAE-6078 (0378)	Escuadra de tiro 9 x 11 mm
	TPAE-6006 (0306)	Escuadra de tiro 25 x 15 mm
	TPAE-6008 (0308)	Escuadra de tiro 25 x 40 mm
	TPAE-6100 (F400)	Escuadra expansión 25 x 15 mm
	TPAE-6104 (F404)	Escuadra expansión 25 x 40 mm
	TPAE-6199 (F899)	Escuadra expansión 25 x 15 mm descentrada
	TPAE-6106 (0363)	Escuadra expansión 9 x 11 mm
	TPAE-7360 (0360)	Escuadra exterior para hoja de puerta

ESCUADRAS REGULABLES

	TPAE-8114 (122514C)	Escuadra regulable 25 x 15 mm
	TPAE-8010 (0910)	Escuadra de tiro regulable 25 x 15 mm
	TPAE-8115	Escuadra regulable 9 x 11 mm

ESCUADRAS ALINEACIÓN

ESQUEMA	REF	DESCRIPCIÓN
	TPAE-7359 (0359)	Escuadra alineación inox
	TPAE-7365 (0365)	Escuadra alineación hoja interior
	TPAE-7013 (F2013)	Escuadra alineación FUJI
	TPAE-6190 (F890)	Escuadra alineación PT45-1990 (RT890)
	TPAE-6193	Escuadra alineación interior PT45-0411
	TPAE-7310	Escuadra alineación hoja



ESCUADRAS TAPAJUNTAS

	TPAE-7302 (MP2)	Escuadra registro persiana
	TPAE-7304 (MP4)	Escuadra universal
	TPAE-7359 (0359)	Escuadra alineación inox
	TPAE-7303 (MP3)	Escuadra alineación

UNIONES FIJAS

ESQUEMA	REF	DESCRIPCIÓN
	TPAE-6144 (U404)	Unión 15 x 18 mm extrusión
	TPAE-6145 (U405)	Unión 40 x 18 mm extrusión
	TPAE-6148 (U408)	Unión 15 x 18 mm extrusión reforzada
	TPAE-6140	Unión 15 x 25 mm peana con marco
	TPAE-0393	Unión 25 x 12 mm para enlazar marcos de forma continua
	HA70-0393	Unión 9 x 11 mm para enlazar marcos de forma continua

UNIONES REGULABLES

	TPAE-8144 (U411)	Unión regulable 15 x 18 mm
	TPAE-8145 (U410)	Unión regulable 40 x 18 mm

TAPAS ESTANQUEIDAD

	PA45-G419 (1912)	Juego tapas para PT45-2390 (RT823)
	AA45-G419 (1903)	Juego tapas para AT45-2390 (RT023)
	PA45-G499	Juego tapas para una hoja acoplada a perfil PT45-7098
	PA45-G492	Juego tapas para dos hojas perfil PT45-7098
	PA45-G493	Juego tapas lateral para perfil PT45-0830
	PA45-G494	Juego tapas lateral para perfil PT45-0800
	CNA0-0279	Tapa para perfil de refuerzo TP07-0279
	NA10-0279	Tapa para perfil de refuerzo NT10-0279
	CNA0-0023	Tapa para perfil escupidor TP07-0023





SISTEMA CIERRE INFERIOR OCULTO

ESQUEMA	REF	DESCRIPCIÓN
	CPA0-M610 (M610)	Cierre inferior oculto para hoja de 700 a 800 mm
	CPA0-M611 (M611)	Cierre inferior oculto para hoja de 800 a 900 mm
	CPA0-M612 (M612)	Cierre inferior oculto para hoja de 900 a 1000 mm

GOMAS SISTEMA

	PA45-G100 (EXA800K)	Tercera goma estanqueidad marco
	PA45-G000 (JIP800K)	Goma junta central
	PA45-G009 (7545)	Ángulo vulcanizado para junta PA45-G000 (JIP800K)
	CPAG-G900 (3553)	Goma burbuja interior hoja
	CPAG-G907	Goma interior hoja para el corte continuo perimétrico
	CPAG-G701 (CL1K)	Goma registro persiana
	CPAG-0533 (E533)	Espuma registro persiana
	CPAG-G906 (3559)	Goma cuña interior hoja
	CNAP-5009 (F5X9)	Felpa 5 x 9 mm
	CPAG-1027 (E1027)	Foam Isolation System 10 x 27 mm

GOMAS ACRISTALAMIENTO EXTERIOR

	PA45-G100 (EXA800K)	Tercera goma estanqueidad marco
	CPAG-G509 (GA9K)	Goma vidrio 3 m
	CPAG-G510 (GA10K)	Goma vidrio 4 m
	CPAG-G511 (GA11K)	Goma vidrio 6 m

GOMAS CUÑA TRADICIONALES

ESQUEMA	REF	DESCRIPCIÓN
	CPAG-G7-1 (CF10P)	Goma de cuña interior
	CPAG-G7-0 (CF10)	Goma de cuña interior para acristalamiento 3 mm
	CPAG-G600	Goma de cuña interior tradicional para acristalamiento 3/3,5 mm
	CPAG-G602	Goma de cuña interior tradicional para acristalamiento 4/4,5 mm
	CPAG-G604	Goma de cuña interior tradicional para acristalamiento 5/5,5 mm
	CPAG-G607	Goma de cuña interior tradicional para acristalamiento 7/7,5 mm
	CPAG-G610	Goma de cuña interior tradicional para acristalamiento 9/9,5 mm

GOMAS CUÑA PRECORTADAS

	CPAG-G700 (CL0K)	Goma de cuña interior precortada para acristalamiento B=3 mm (blanca)
	CPAG-G702 (CL2K)	Goma de cuña interior precortada para acristalamiento B=4 mm (roja)
	CPAG-G704 (CL4K)	Goma de cuña interior precortada para acristalamiento B=5 mm (azul)
	CPAG-G707 (CL7K)	Goma de cuña interior precortada para acristalamiento B=7 mm (verde)
	CPAG-G710 (CL10K)	Goma de cuña interior precortada para acristalamiento B=10 mm (amarilla)

ACCESORIOS ESPECÍFICOS PORTICÓN INTERNO

ESQUEMA	REF	DESCRIPCIÓN
	TPAE-6106 (0363)	Escuadra expansión 9 x 11 mm
	TPAE-6078 (0378)	Escuadra de tiro 9 x 11 mm
	OA30-0004 (K004)	Calzo para la bisagra OA30-0005 plegable
	OA30-0005 (K005)	Bisagra para mallorquina plegable
	OA30-0006	Bisagra una pala
	OA30-1650	Cierre a presión para porticón interno
	OA60-G905	Goma mallorquina para media lámina
	CPAG-G900 (3553)	Goma burbuja interior hoja
ACCESORIO AIREADOR		
	TPA0-3693	Aireador por gradiente atmosférico



PROVISIONAL 24/10/2023

VENTANA DE DOS HOJAS CON CLIPAJE FRONTAL

PT45(B2=200D(0));2

PT45
25

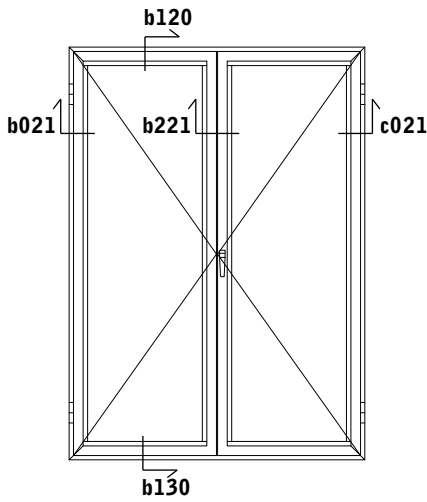

INVERSOR PT45-2390 (RT823): H-115

SECCIÓN VERTICAL
b120-b130

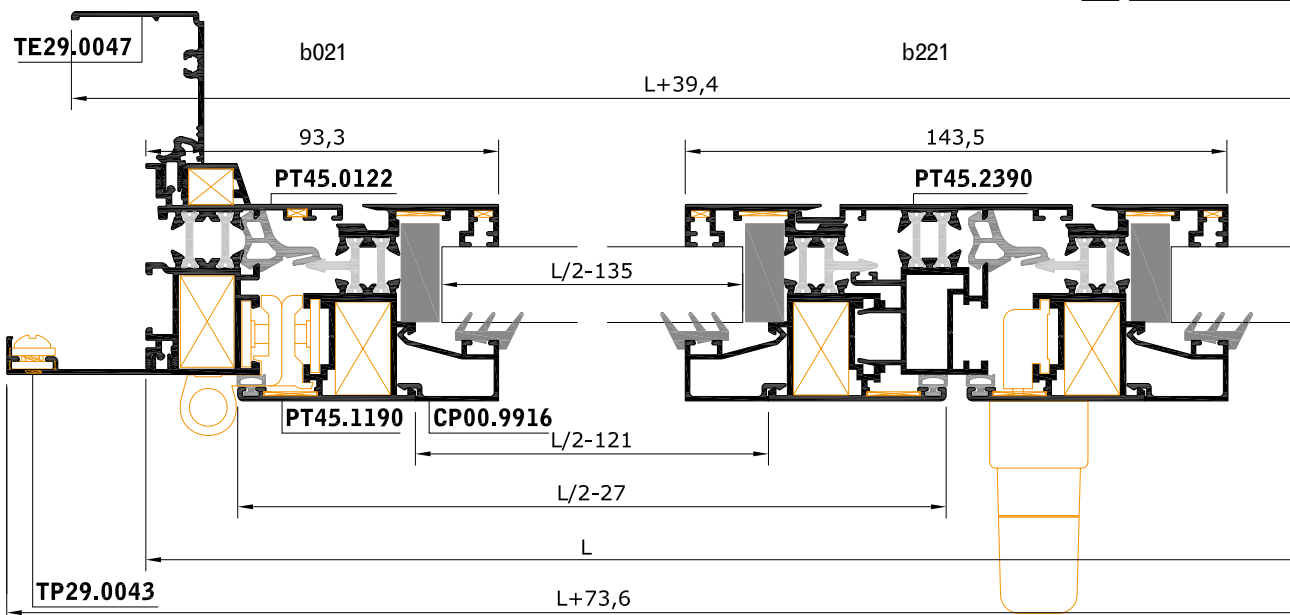
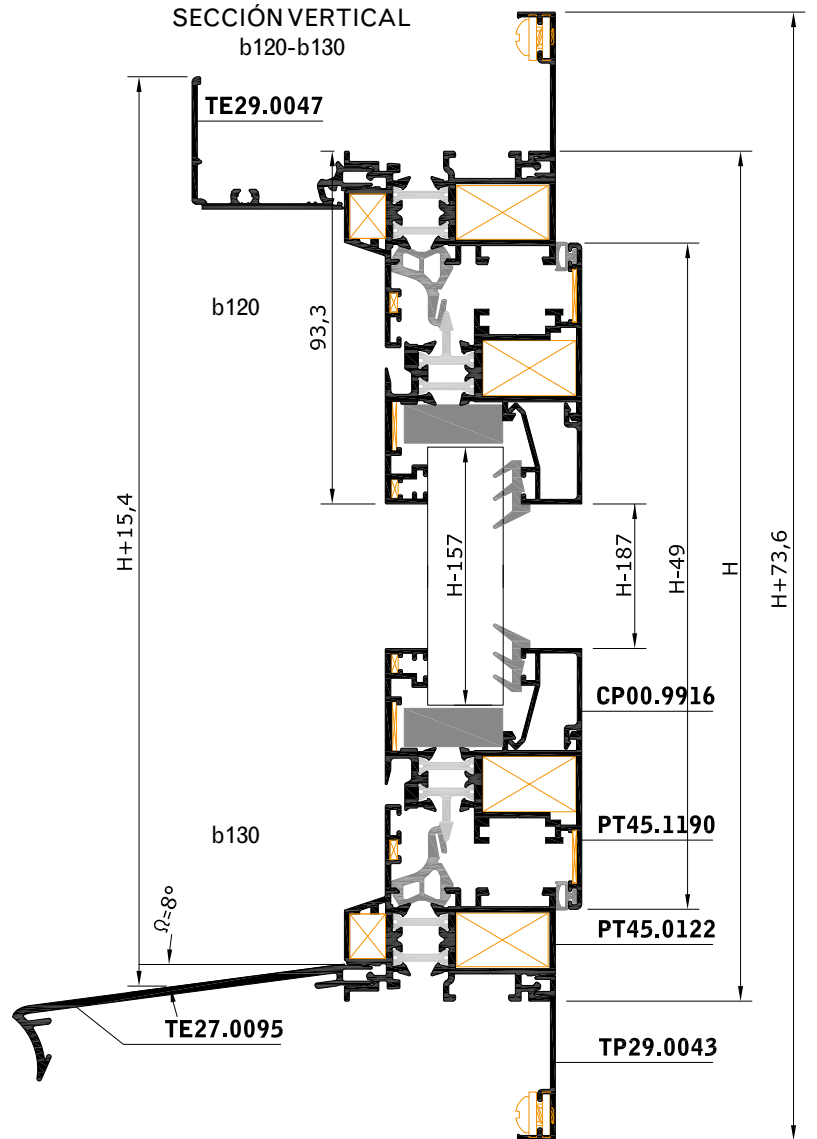

SECCIÓN HORIZONTAL b021-b221

