

La división de fabricación y elaboración de accesorios de Innaltech-Woorbel, dispone de herrajes específicos para la elaboración de plegables de cámara europea. Éstos se pueden aplicar de forma universal en cualquier sistema de practicable de cámara europea que disponga de un marco de una altura mínima de 40 mm en el lado interior. Estos herrajes son de aplicación estándar en las series Alfil 45 (PF43), Practic 45 RPT (PT45), Practic 54 RPT (PT54) y Practic 80 RPT (PT80).

El sistema va suspendido desde la guía superior mediante carros de cuatro ruedas con cojinetes de agujas de ejes inox de 6 mm. Estos carros se deslizan suavemente dentro de una guía de doble banda de rodadura que garantiza la ausencia total de cabeceamientos.

La guía inferior puede ser sobrepuesta o bien empotrada. Esta última posibilidad, en la Practic 54 RPT, es compatible con la utilización de peana, siendo ésta una aplicación óptima, ya que combina la practicidad del sistema plegable, su gran estanqueidad y la ausencia de obstáculos inferiores sobre el suelo.

Es un sistema versátil, de fácil instalación y que garantiza una gran estanqueidad, idóneo para espacios abiertos, que alternan diferentes funcionalidades dependiendo de las estaciones del año o bien la climatología reinante. Es idóneo para terrazas, porchos, jardines, piscinas, etc. Sin duda, la plegable, es un sistema de cerramiento que admite multitud de aplicaciones y que permite hacer posibles espacios con usos apriorísticamente incompatibles.

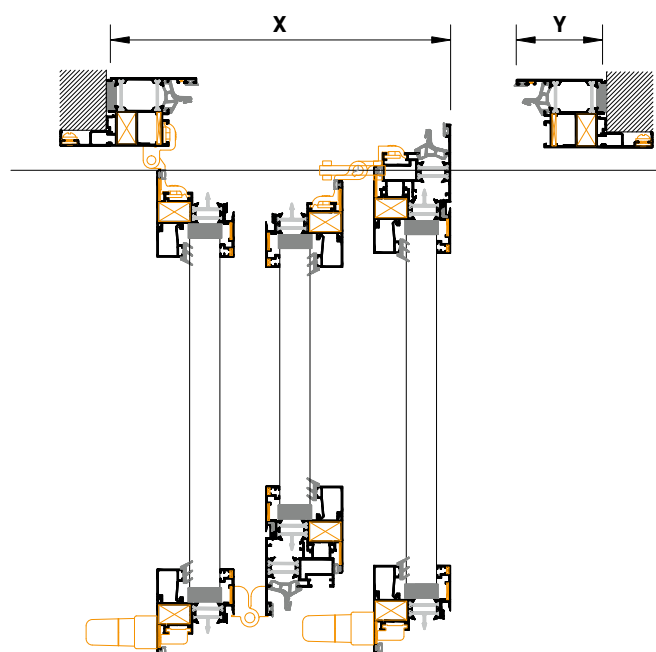
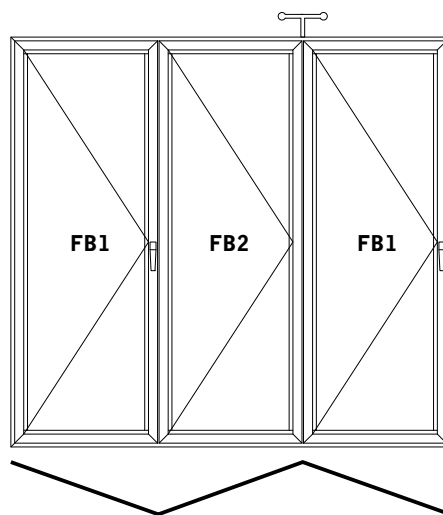

PESOS MÁXIMOS RECOMENDADOS
POR HOJA (KG / HOJA)

Tipología plegable (*)	Anchura / Dimensión hoja			
	800 mm	700 mm	600 mm	500 mm
P200E2 (2 + 0)	55	60	70	75
P300E3 (3 + 0)	35	45	50	55
P300D1 (2 + 1)	55	60	70	75
P400E4 (4 + 0)	40	55	60	65
P400D1 (3 + 1)	35	45	50	55
P500E5 (5 + 0)	25	35	45	50
P500D1 (4 + 1)	40	55	60	65
P500D2 (3 + 2)	35	45	50	55
P600E6 (6 + 0)	30	50	55	60
P600D1 (5 + 1)	25	35	45	50
P600D3 (3 + 3)	35	45	50	55
P700E7 (7 + 0)	20	30	40	45
P700D1 (6 + 1)	30	50	55	60
P700D2 (5 + 2)	25	35	45	50
P700D3 (4 + 3)	35	45	50	55
P900E9 (9 + 0)	15	25	35	40
P900D1 (8 + 1)	15	25	35	40
P900D2 (7 + 2)	20	30	40	45
P900D3 (6 + 3)	30	45	50	55
P900D4 (5 + 4)	25	35	45	50

(*) Para alturas mayores de 1800 mm recomendable utilizar hojas de puerta

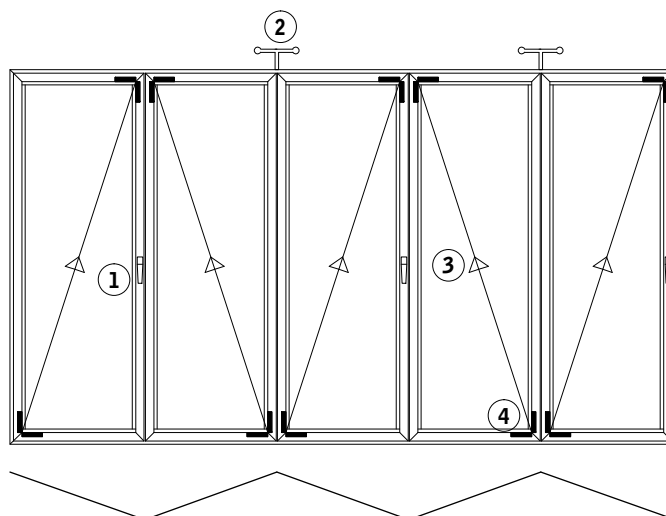
FALCADO DE CRISTALES

LEYENDA

1		Manilla	3		Dirección tensional
2		Carros superiores	4		Falca

CARACTERÍSTICAS DE LOS COMPONENTES

Colores: El herraje se presenta en lacado Blanco 9016 y Negro 9011 Mate, así como anodizado Plata Mate. También se pueden lacar en otros colores según requerimiento del cliente. Para más información consultar la tabla de acabados.

Carro superior: Compuesto por conjunto de 4 ruedas dispuestas horizontalmente en posición 2 + 2.

Carro inferior: Compuesto por doble rueda en guiamento vertical montada sobre pieza de zamac con tratamiento anticorrosivo y muelle de nivelación en inoxidable AISI 302.

Pernio: Compuesto por tres cuerpos integrados de aluminio extruido aleación 6063T5. Fijación a los perfiles de aluminio mediante placas de inoxidable AISI 430 y tornillería A2. Eje de 8 mm de inoxidable AISI 303 y casquillos de plástico inyectado antifricción.

Tornillo de regulación: Regulación vertical de 6 mm mediante tuerca de acero inoxidable con fijación automática y sin tornillos tanto en el carro superior como el inferior.

Banda de rodadura: Torneada sobre resinas especiales extruidas de alta resistencia a la fricción y al aplastamiento por peso. Diámetro de 20 mm.

Cojinete: Agujas de alta calidad. Posibilidad de acabado anticorrosivo Corrotect®.

Eje del cojinete: Eje de 6 mm de diámetro de acero inoxidable AISI 303.

Porta ruedas: Aluminio extruido aleación 6063T5. Acabado en anodizado plata mate de 15 micras.

Eje de regulación vertical: Eje de 8 mm estampado de transmisión vertical de inoxidable AISI 303.



PROVISIONAL 16/10/2024

P200E2 (2+0)

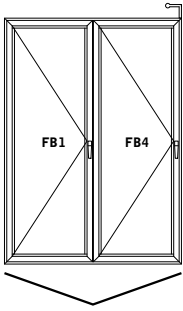

P300E3 (3+0)

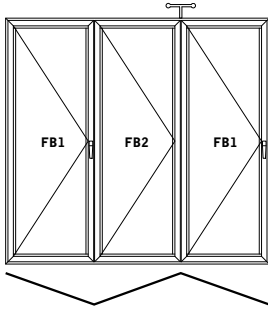

P300D1 (2+1)

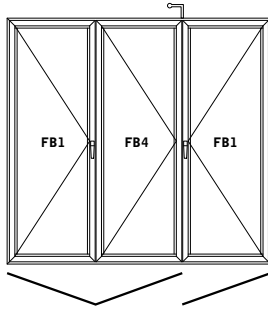

P400E4 (4+0)

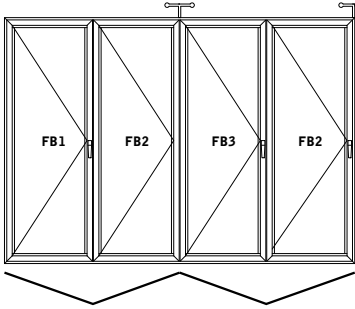

P400D1 (3+1)

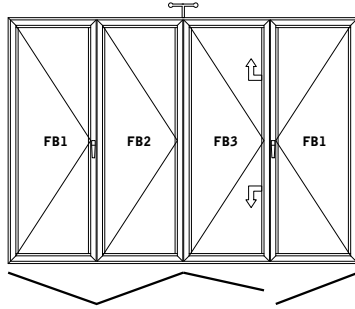

P500E5 (5+0)

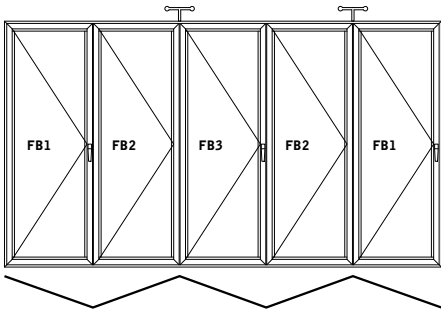

P500D1 (4+1)

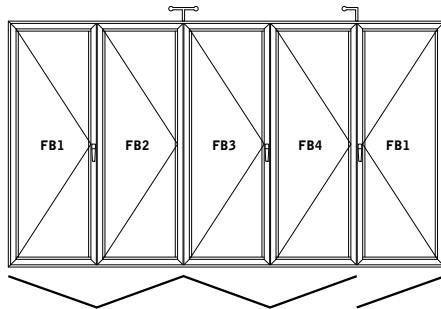

P500D2 (3+2)

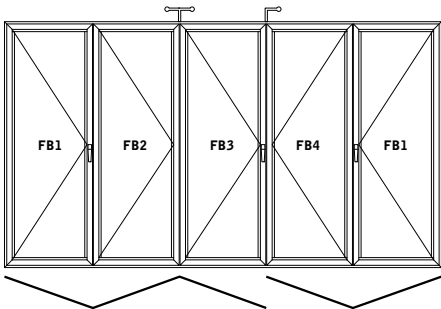

P600E6 (6+0)

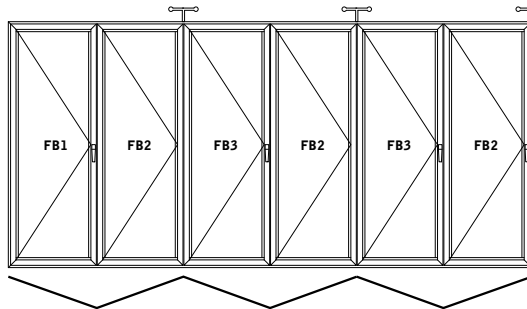

Todas las aplicaciones de plegable se pueden realizar en hojas de apertura exterior.



P600D1 (5+1)

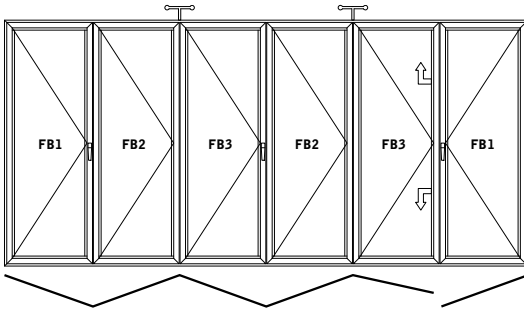

P600D3 (3+3)

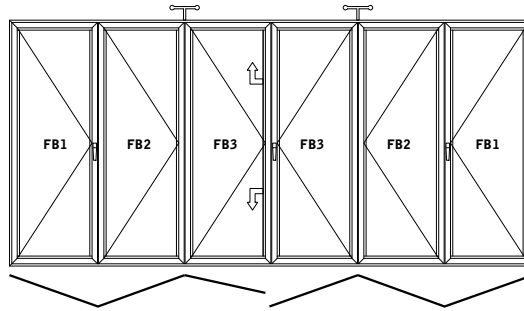

P700E7 (7+0)

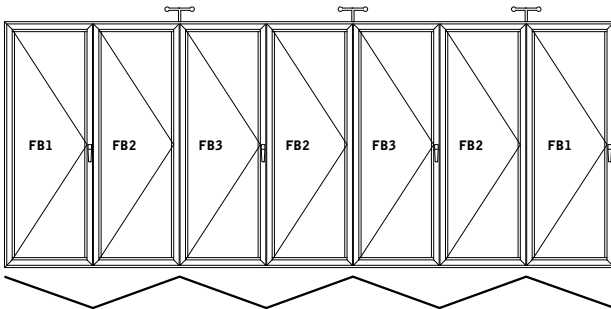

P700D1 (6+1)

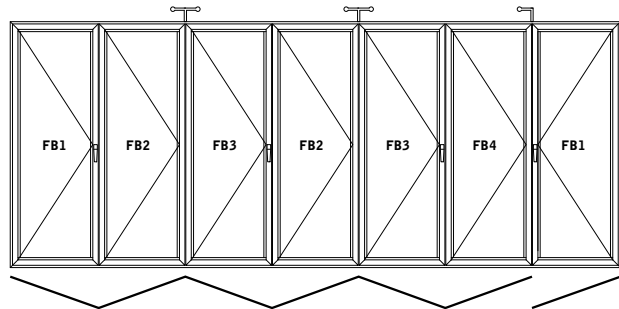

P700D2 (5+2)

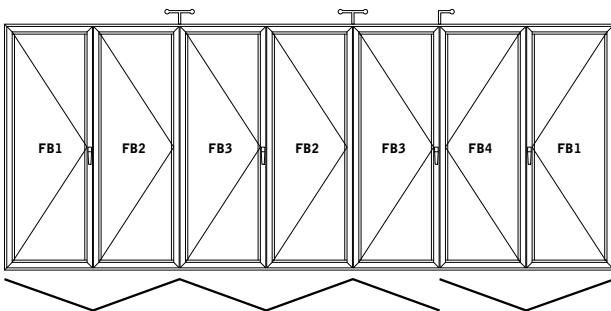

P700D3 (4+3)

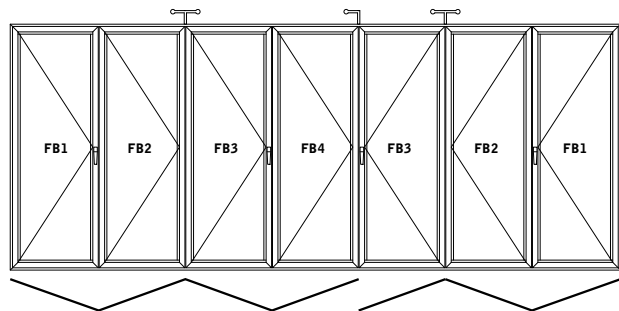

P900E9 (9+0)

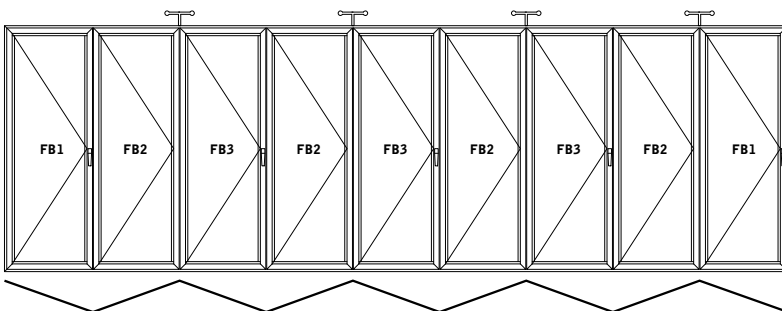

P900D1 (8+1)

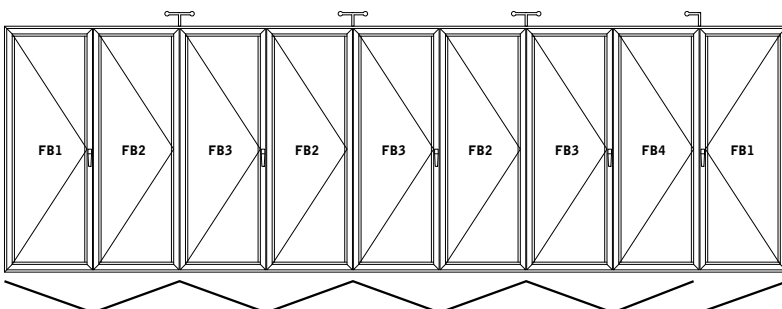

Todas las aplicaciones de plegable se pueden realizar en hojas de apertura exterior.



PROVISIONAL 16/10/2024

P900D2 (7+2)

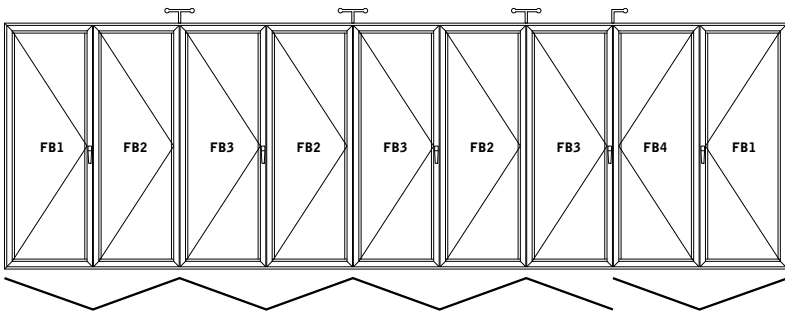

P900D3 (6+3)

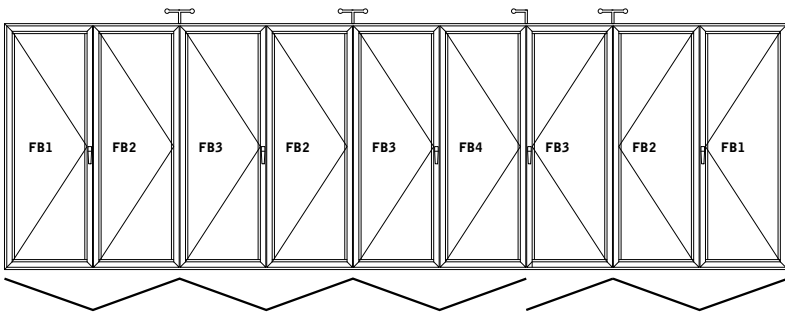

P900D4 (5+4)

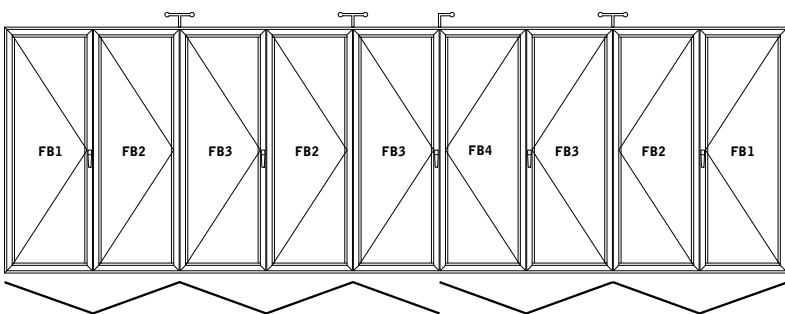

PERFILES · GUÍAS SISTEMA

GUÍAS PARA PLEGABLES CAMARA EUROPEA

W00R-9092

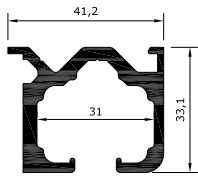

W00R-9091

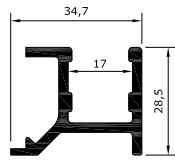

OM60-9091

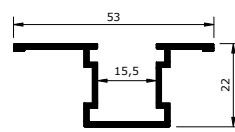

OM60-0800

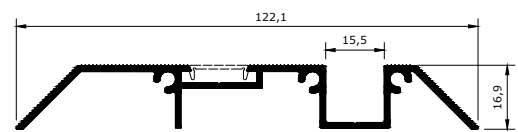

PERFILES · ALFIL 45

MARCO

HOJAS APERTURA INTERIOR

PF43-0400
(58958)

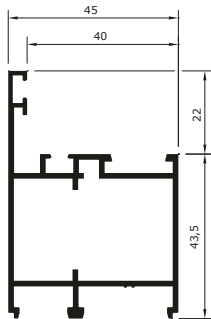

PF43-1160
(62673)

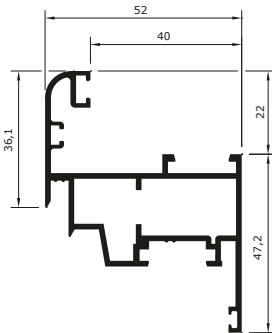

PF43-1190
(59735)

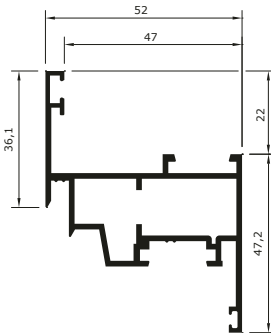

PF43-1360
(65188)

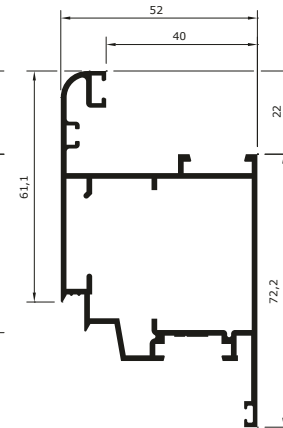

PF43-1390
(58963)

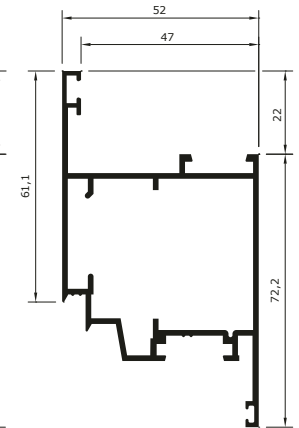

HOJAS APERTURA EXTERIOR

PF43-1960
(70215)

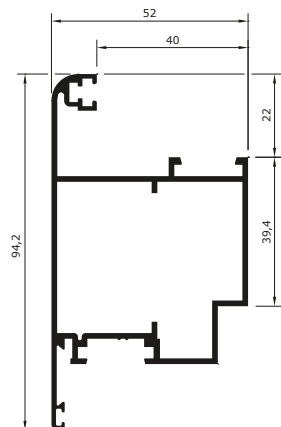

PF43-1990
(61139)

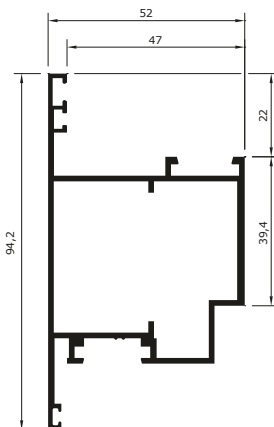

**INVERSOR
APERTURA INTERIOR**

PF43-2390
(59734)

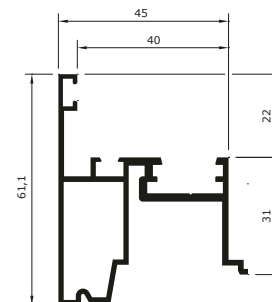

**INVERSOR
APERTURA EXTERIOR**

PF43-2990
(61140)

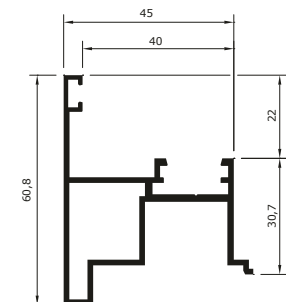

TRAVESAÑOS, ZÓCALOS Y COMPLEMENTARIOS PARA HOJAS CURVAS

PF43-3140
(60893)

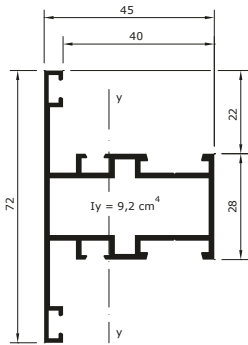

PF43-3340
(62285)

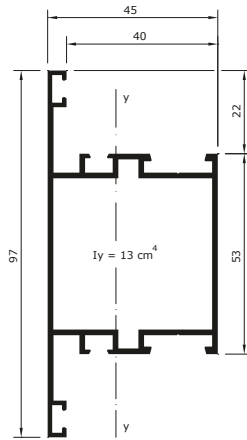

OF52-3540
(5052)

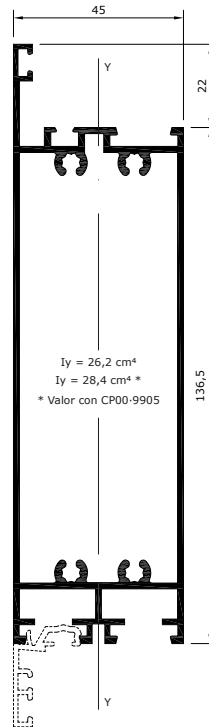

OM60-7098
(69865)



TRAVESAÑOS, ZÓCALOS Y COMPLEMENTARIOS PARA HOJAS RECTAS

PF43-3150
(60892)

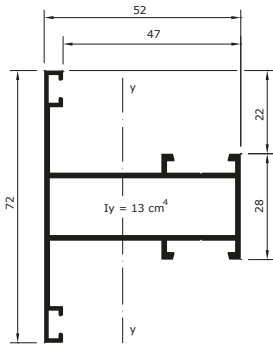

PF43-3450
(58953)

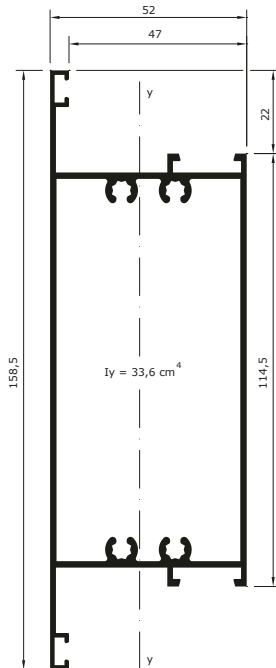

PF43-7098
(58962)

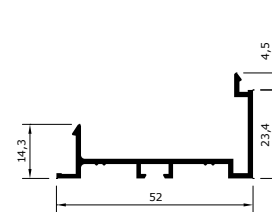



MARCO

HOJAS APERTURA INTERIOR

PT45-0411

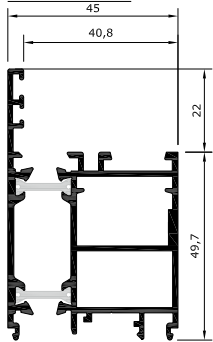

PT45-1170

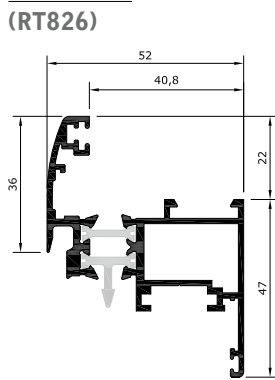

PT45-1190

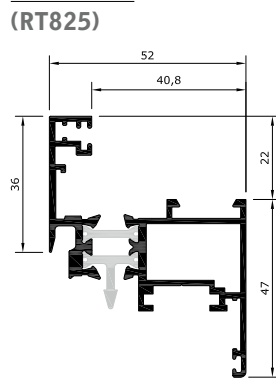

PT45-1360

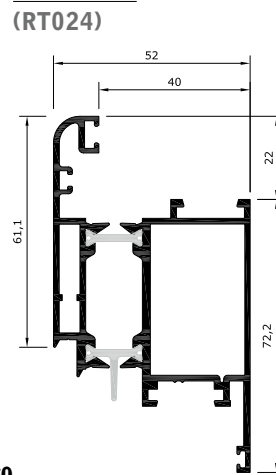

PT45-1390

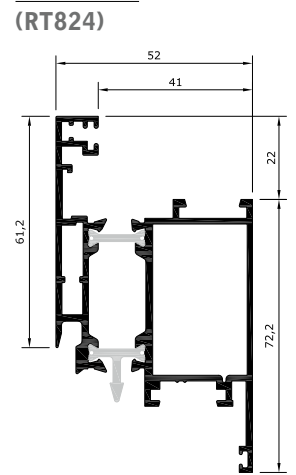

HOJA APERTURA EXTERIOR

INVERSOR

INVERSOR PARA PT45-1360

PT45-1990

(RT890)

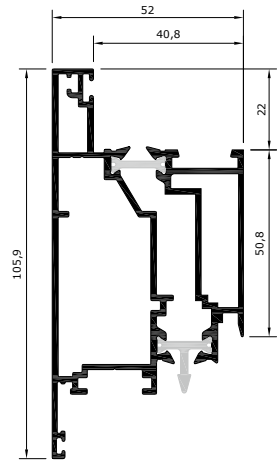

PT45-2390

(RT823)

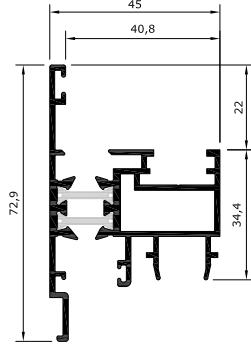

AT45-2390

(RT023)

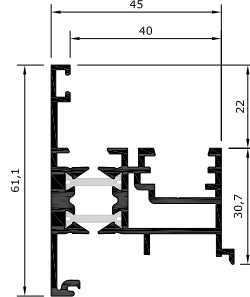

PERFILES PARA CIERRE BAJO PUERTA

PT45-7098

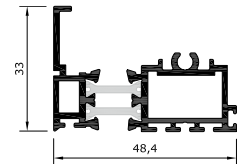

TRAVESAÑOS, ZÓCALOS Y COMPLEMENTARIOS

PT45-3140

(RT815)

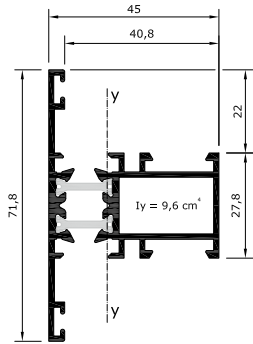

PT45-3340

(RT808)

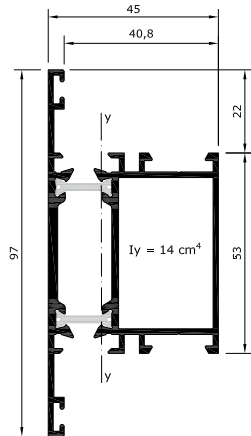

PT45-3240

(RT807)

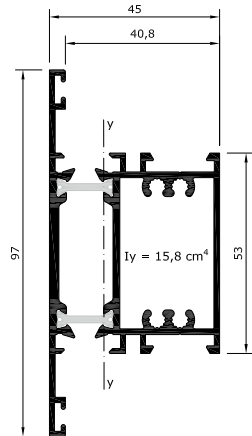

PT45-3440

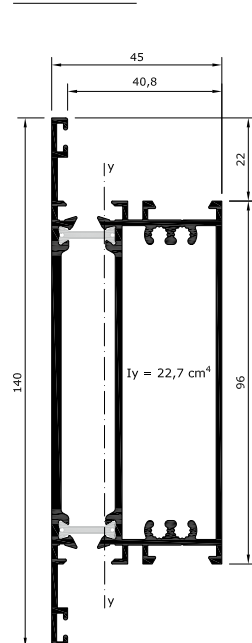

OM60-7098

(69865)

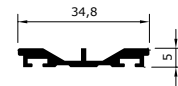



MARCO

PT54-0411

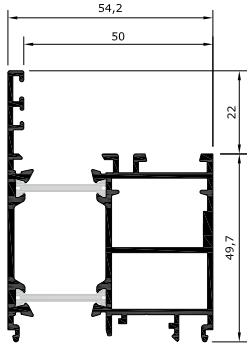

HOJAS APERTURA INTERIOR

PT54-1170

(RTS826)

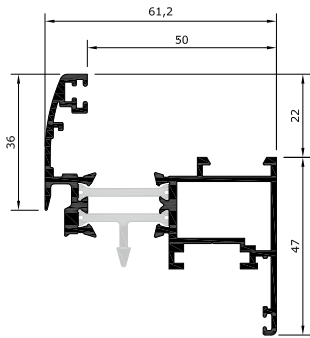

PT54-1190

(RTS825)

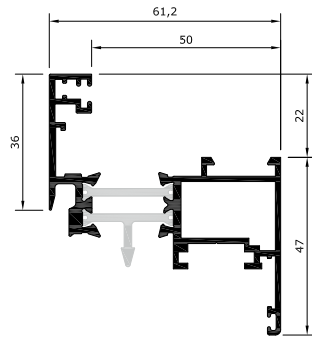

PT5+-1190

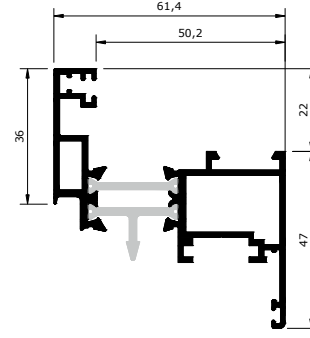

PT54-1390

(RTS824)

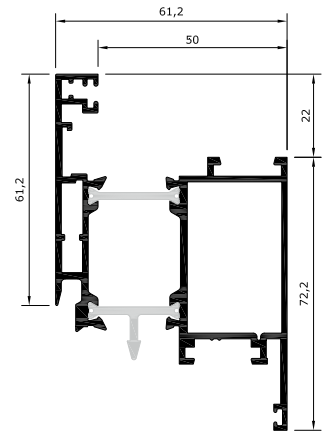

HOJAS APERTURA INTERIOR

PT5+-1390

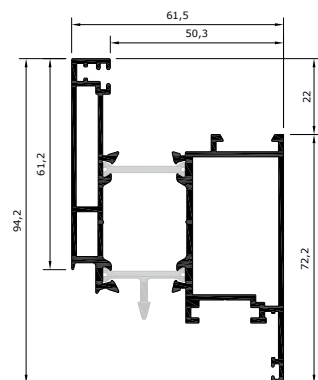

HOJA APERTURA EXTERIOR

PT54-1990

(RTS890)

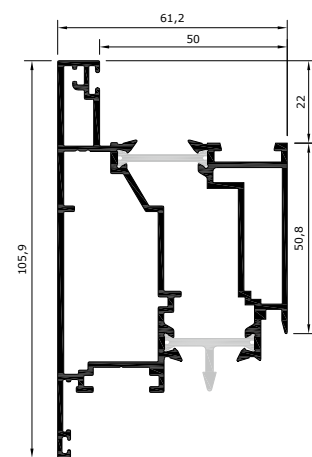

INVERSOR

PT54-2390

(RTS823)

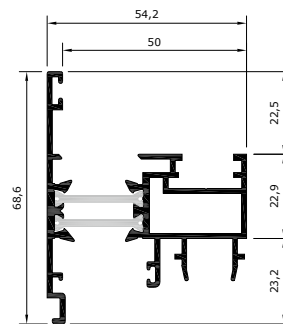

INVERSOR PARA PT5+-1190, PT5+-1390

PT5+-2390

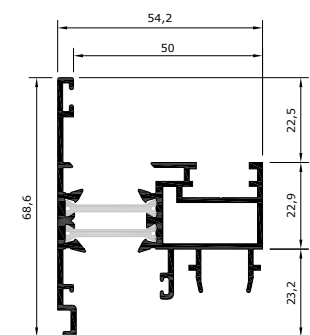

TRAVESAÑOS, ZÓCALOS Y COMPLEMENTARIOS

PT54-3140
(RTS815)

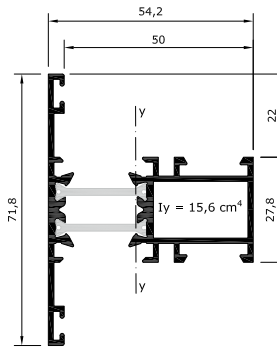

PT54-3340
(RTS808)

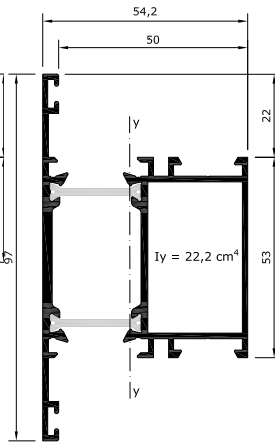

PT54-3240
(RTS807)

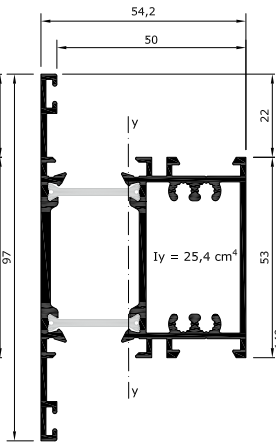

PT54-3440

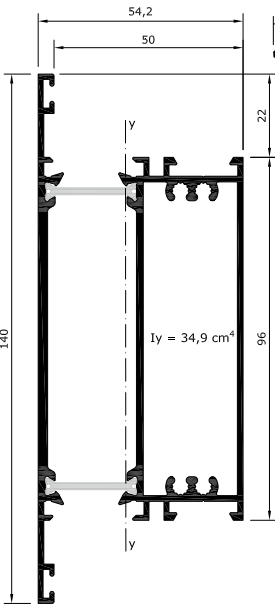

OM60-7098
(69865)

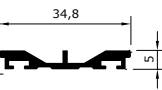

PERFILES PARA CIERRE BAJO PUERTA

PT54-7098

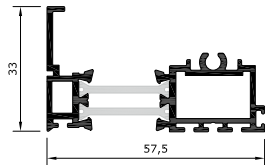

PT54-0830

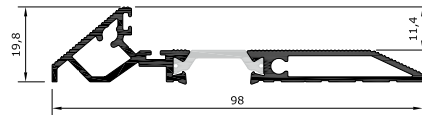

PT45-0800

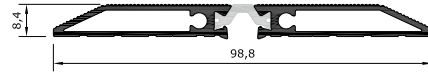



MARCOS

PT80-0411

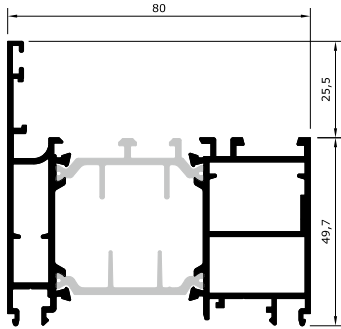

HOJAS APERTURA INTERIOR

PT80-1190

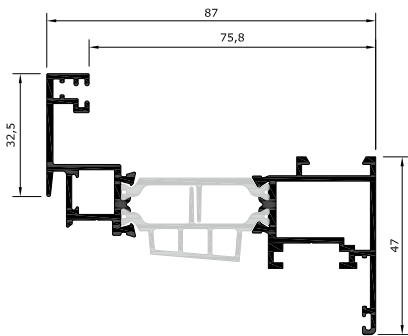

PT80-1390

NOVEDAD

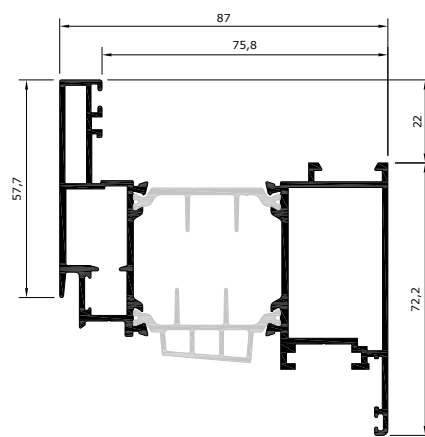

INVERSOR

PT80-2390

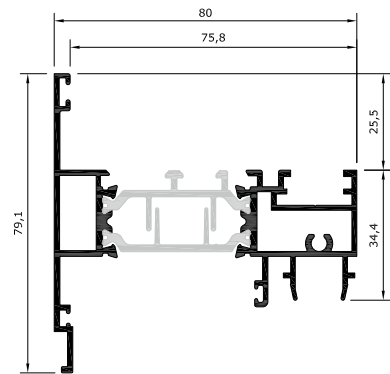

HOJA APERTURA EXTERIOR

PT80-1990

NOVEDAD

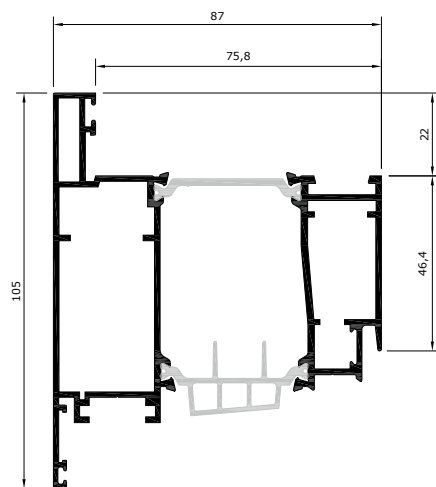



PERFILES ESTRUCTURALES (MONTANTES Y TRAVESAÑOS)

PT80-3340

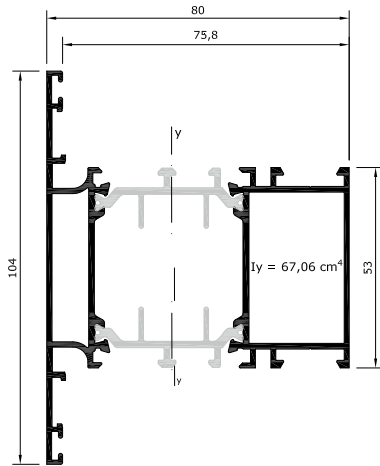

PT80-3240

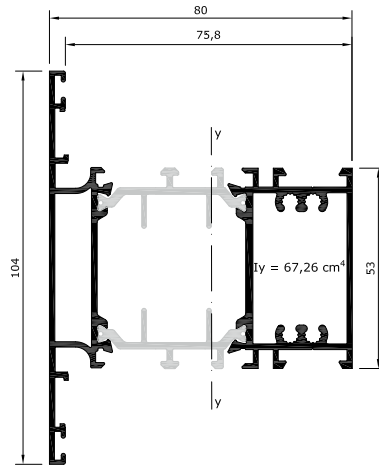

PERFILES PARA CIERRE BAJO PUERTA

PT80-7098

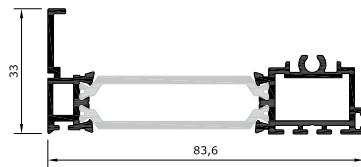

PT54-0830

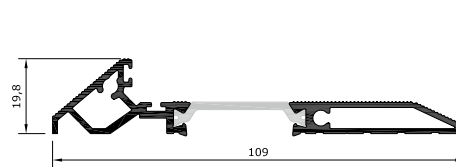



ALFIL 45 · RELACIÓN JUNQUILLO - GROSOR VIDRIO

		JUNQUILLOS								
		36	31	26	21	18	16	11	3	
Opcción 1										
	CP00-9936 (59850)	CP00-9931 (59849)	CP00-9926 (58948)	CP00-9921 (58949)			CP00-9916 (59848)	CP00-9911 (59847)	CP00-9903 (70796)	
Opcción 2										
	CP00-9936 CP00-9736 (59850) (5066)		CP00-9926 CP00-9726 (58948) (5059)	CP00-9921 CP00-9721 (58949) (5058)			CP00-9916 CP00-9716 (59848) (5057)	CP00-9911 CP00-9711 (59847) (5056)		
Opcción 3										
	CP00-9636 CP00-9836 (68137) (67360)		CP00-9626 CP00-9826 (64053) (66236)			CP00-9618 CP00-9818 (64246) (65793)		CP00-9611 CP00-9811 (64248) (66235)		
		HUECO HOJAS RECTAS (mm)								
		11	16	21	26	29	31	36	44	
		HUECO MARCOS Y HOJAS CURVAS (mm)								
		4	9	14	19	22	24	29	37	

PRACTIC 45 RPT · RELACIÓN JUNQUILLO - GROSOR VIDRIO

		JUNQUILLOS								
		36	31	26	21	18	16	11	3	
Opcción 1										
	CP00-9936 (59850)	CP00-9931 (59849)	CP00-9926 (58948)	CP00-9921 (58949)			CP00-9916 (59848)	CP00-9911 (59847)	CP00-9903 (70796)	
Opcción 2										
	CP00-9936 CP00-9736 (59850) (5066)		CP00-9926 CP00-9726 (58948) (5059)	CP00-9921 CP00-9721 (58949) (5058)			CP00-9916 CP00-9716 (59848) (5057)	CP00-9911 CP00-9711 (59847) (5056)		
Opcción 3										
	CP00-9636 CP00-9836 (68137) (67360)		CP00-9626 CP00-9826 (64053) (66236)			CP00-9618 CP00-9818 (64246) (65793)		CP00-9611 CP00-9811 (64248) (66235)		
		HUECO (A) (mm)								
		4,8	9,8	14,8	19,8	22,8	24,8	29,8	37,8	

PRACTIC 54 RPT · RELACIÓN JUNQUILLO - GROSOR VIDRIO

		JUNQUILLOS								
		36	31	26	21	18	16	11	3	
Opcción 1										
	CP00-9936 (59850)	CP00-9931 (59849)	CP00-9926 (58948)	CP00-9921 (58949)			CP00-9916 (59848)	CP00-9911 (59847)	CP00-9903 (70796)	
Opcción 2										
	CP00-9936 CP00-9736 (59850) (5066)		CP00-9926 CP00-9726 (58948) (5059)	CP00-9921 CP00-9721 (58949) (5058)			CP00-9916 CP00-9716 (59848) (5057)	CP00-9911 CP00-9711 (59847) (5056)		
Opcción 3										
	CP00-9636 CP00-9836 (68137) (67360)		CP00-9626 CP00-9826 (64053) (66236)			CP00-9618 CP00-9818 (64246) (65793)		CP00-9611 CP00-9811 (64248) (66235)		
		HUECO (mm)								
		14	19	24	29	32	34	39	47	

PRACTIC 80 RPT · RELACIÓN JUNQUILLO - GROSOR VIDRIO

		JUNQUILLOS									
		36	31	26	21	18	16	11	3		
Opción 1											
Opción 2											
Opción 3											
		HUECO (mm)									
		40	45	50	55	58	60	65	73		







SISTEMA PLEGABLE HERRAJE CANAL EUROPEO

ESQUEMA	REF	DESCRIPCIÓN
	WOOR-9826	Bisagra plegable marco / hoja
	WOOR-9826T	Bisagra plegable inversor / hoja Canal Europeo
	WOOR-9827	Bisagra plegable inversor / hoja ventana sobrepuesta
	WOOR-9827H	Bisagra plegable inversor / hoja puerta sobrepuesta
	WOOR-1352	Juego de carros superior e inferior para plegable
	WOOR-1352T	Juego de carros final sobre inversor superior e inferior para plegable
	WOOR-1352H	Juego de carros final sobre hoja superior e inferior para plegable
	WOOR-0000	Plantilla para la colocación de la bisagra sobrepuesta WOOR-9827 / 9827H

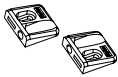

CREMONAS Y MANILLAS 2 PALAS PARA APERTURAS INTERIORES

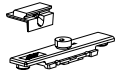
ESQUEMA	REF	DESCRIPCIÓN
	CRAS-0760	Cremona línea CRASH exclusiva Innaltech
	CPAF-0787 (F787)	Cremona de dos palas MIDI
	CPAF-0540	Cremona de dos palas GEA
	CPAF-0791 (F791)	Cremona de dos palas NEFER con llave
	CPAF-0541	Cremona de dos palas GEA con llave
	CPAF-0792 (F792)	Cremona de dos palas GEA extraíble
	CPAF-0783 (F783)	Manilla para cremona CPAF-0792 (F792), CPAF-0762 (F762) y CPAF-0642 (F642)

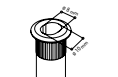
ACCESORIOS PARA CREMONA CÁMARA EUROPEA

ESQUEMA	REF	DESCRIPCIÓN
	CRAS-1760D CRAS-1760E	Dos palas para cremona CRAS-0760 derechas Dos palas para cremona CRAS-0760 izquierdas
	CPA0-9232 (9232) CRAS-9232	Kit ventana 1 hoja para cremona de dos palas plástico Kit ventana 1 hoja para cremona CRASH de dos palas
	CPAF-1575 (F1575)	Contraplacas fijación reforzada cremona
	CPAF-1636 (F1636)	Sistema antipalanca
	CPAF-1585 (F1585)	Punto de cierre universal
	CPAF-1597A (F1597A)	Punto de cierre marco universal regulable
	CPAF-1596C	Punto de cierre hoja universal regulable
	CPAF-1895 (F1895)	Cerradero al suelo inox LOTHUS

CREMONAS, MANILLAS Y HERRAJES PARA CUADRADILLO DE 7 MM PARA APERTURAS EXTERIORES

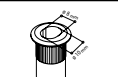
	WOOR-1005	Manilla extra plana para sistema plegable apertura exterior
	CPAF-0651 (F651)	Mecanismo unidireccional para Practic RPT apertura exterior (e=40)
	CPAF-1895 (F1895)	Cerradero al suelo inox LOTHUS



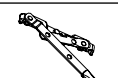
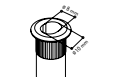



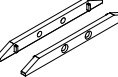
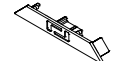

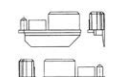
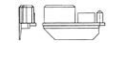

PASADORES VENTANA CÁMARA EUROPEA

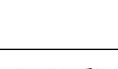
	CPAF-3865 (F3865)	Juego pasadores palanca extensibles
	CPAF-1508 (F1508)	Kit de pasadores con accionamiento con palanca
	CPAF-1895 (F1895)	Cerradero al suelo inox LOTHUS

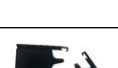

TAPAS GUÍAS LATERALES

	WOOR-G494	Juego tapas laterales para guía superior WOOR-9092
	WOOR-G493	Juego tapas laterales para guía inferior WOOR-9091
	PA45-G493	Juego tapas laterales para PT45 / PT54 / PT65 / PT80-0830
	PA45-G494	Juego tapas laterales para PT45-0800
	OA60-0800	Tapa para perfil OM60-0800

TAPAS PARA PERFILES INVERSORES

ESQUEMA	REF	DESCRIPCIÓN
	PA43-G419	Juego tapas para perfil inversor PF43-2390 (59734)
	PA43-G493	Juego tapas para perfil inversor PF43-2990 (61140)
	PA45-G419	Juego tapas para perfil inversor PT45-2390 (RT823)
	PA54-G419	Juego tapas para perfil inversor PT54-2390 (RTS823)
	PA80-G419	Juego tapas para perfil inversor PT80-2390
	PA43-G418	Juego tapas para perfil inversor con peana PT45-0830 + OM60-9091
	PA45-G418	Juego tapas para perfil inversor con peana PT45-0830 + OM60-9091
	PA54-G418	Juego tapas para perfil inversor con peana PT54-0830 + OM60-9091
	PA80-G418	Juego tapas para perfil inversor con peana PT65-0830 + OM60-9091
	PA43-G492	Juego tapas para perfil inversor con peana PT45-0800 + OM60-9091/OM60-0800
	PA45-G492	Juego tapas para perfil inversor con peana PT45-0800 + OM60-9091/OM60-0800
	PA54-G492	Juego tapas para perfil inversor con peana PT54-0800 + OM60-9091/OM60-0800

TAPAS PARA HOJAS ACOPLADAS AL PERFIL PT-7098**

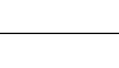
	PA43-G499	Juego tapas para hojas sistema PF43 acopladas al perfil PT45-7098
	PA45-G499	Juego tapas para hojas sistema PT45 acopladas al perfil PT45-7098
	PA54-G499	Juego tapas para hojas sistema PT54 acopladas al perfil PT54-7098
	PA80-G499	Juego tapas para hojas sistema PT80 acopladas al perfil PT80-7098

RELACION DE PERFILES Y TAPAS PARA LAS DISTINTAS GUÍAS Y PERFILES DE PEANAS

ESQUEMA	REF	DESCRIPCIÓN	ESQUEMA	REF	DESCRIPCIÓN
	WOOR-9092	Guía superior sistema plegable		WOOR-G494	Tapa para guía superior plegable Woor-9092
	WOOR-9091	Guía inferior sistema plegable		WOOR-G493	Tapa para guía inferior plegable Woor-9091
	PT45-0800	Peana inferior		PA45-G494	Juego tapas laterales para PT45-0800
	PT45-0830 PT54-0830 PT65-0830	Peana inferior cerrada para Practic 45 RPT / Practic 54 RPT / Practic 80 RPT		PA45-G493	Juego tapas laterales para PT45 / PT54-0830
	OM60-0800	Peana inferior con guía incorporada		OA60-0800	Tapa para peana con guía inferior incorporada
	OM60-9091	Guía inferior empotrada sistema plegable			

SERIE	PEANA	GUÍA
Practic 45 RPT	PT45-0830	OM60-9091 (fresada)
Practic 54 RPT	PT45-0830	OM60-9091
Practic 80 RPT	PT65-0830	OM60-9091

SECCIONES

Sección solución con peana (WOOR-9092, OM60-9091)	Sección solución sin peana (WOOR-9092, OM60-9091)	Sección solución con zócalo (WOOR-9092, OM60-9091, PT54-3340)	Sección solución marco perimetral (WOOR-9092, OM60-9091)

TABLA DE COMPATIBILIDADES DE DIFERENTES TAPAS SEGÚN PERFIL INFERIOR UTILIZADO
DISTINTOS SISTEMAS PARA HACER PLEGABLE









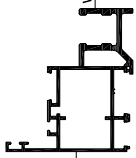

PERFIL INFERIOR		ALFIL 45 (PF43)		PRACTIC 45 RPT (PT45)		PRACTIC 54 RPT (PT54)		PRACTIC 80 RPT (PT80)		
ESQUEMA	REF.	ESQUEMA	REF	ESQUEMA	REF	ESQUEMA	REF	ESQUEMA	REF	
		UNIDADES		UNIDADES		UNIDADES		UNIDADES		
 PF43-0400	PF43-0400 + WOOR-9091 	'=núm de inversores	PA43-G419 (apertura interior)							
		'=núm de inversores	PA43-G493 (apertura exterior)							
			WOOR-G493 (tapa para WOOR-9091)							
 PT45-0411	PT45-0411 + WOOR-9091 		WOOR-G493 (tapa para WOOR-9091)		PA45-G419					
			WOOR-G493 (tapa para WOOR-9091)							
			WOOR-G493 (tapa para WOOR-9091)							
 PT54-0411	PT54-0411 + WOOR-9091 		WOOR-G493 (tapa para WOOR-9091)							
			WOOR-G493 (tapa para WOOR-9091)							
			WOOR-G493 (tapa para WOOR-9091)							
 PT80-0411	PT80-0411 + WOOR-9091 		WOOR-G493 (tapa para WOOR-9091)							
			WOOR-G493 (tapa para WOOR-9091)							
			WOOR-G493 (tapa para WOOR-9091)							
 PT45-0830	PT45-0830 + OM60-9091 	'=núm de inversores	PA43-G419 (apertura interior)		PA45-G419					
		'=núm de hojas	PA43-G499							
		'=núm de inversores	PA43-G418							
			PA45-G493 (tapa para PT45-0830)							

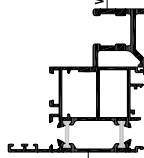
TABLA DE COMPATIVIDADES DE DIFERENTES TAPAS SEGÚN PERFIL INFERIOR UTILIZADO
DISTINTOS SISTEMAS PARA HACER PLEGABLE

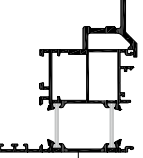

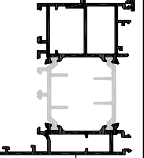

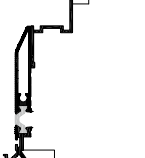

























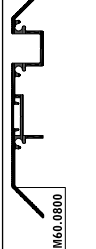

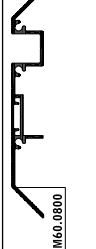
ALFIL 45 (PF43)			PRACTIC 45 RPT (PT45)			PRACTIC 54 RPT (PT54)			PRACTIC 80 RPT (PT80)		
ESQUEMA	REF.	UNIDADES	ESQUEMA	REF.	UNIDADES	ESQUEMA	REF.	UNIDADES	ESQUEMA	REF.	UNIDADES
 PT54-0830 OM60-9091	PA45-G483 (tapa para PT45-0830)		 PT65-0830 OM60-9091	PA45-G483 (tapa para PT45-0830)		 PA54-G419	'=núm de inversores	 PA80-G419 '=núm de inversores	 PA54-G499	'=núm de hojas	 PA80-G499 '=núm de hojas
						 PA54-G418	'=núm de inversores				
 PT45-0800 + OM60-9091	PA43-G419 (tapa para PT45-0800)		 PT45-0800 + OM60-9091	PA43-G419 (tapa para PT45-0800)		 PA45-G419	'=núm de inversores		 PA54-G419 '=núm de inversores	 PA45-G499	
 PA43-G492						'=núm de inversores	 PA43-G492	'=núm de inversores		 PA45-G492 '=núm de inversores	 PA54-G492
 OM60-0800	OA 60-0800 (tapa para OM60-0800)		 OM60-0800	OA 60-0800 (tapa para OM60-0800)		 PA45-G419	'=núm de inversores	 PA54-G419 '=núm de inversores			 PA45-G499
 PA43-G492						'=núm de inversores	 PA43-G492		'=núm de inversores	 PA54-G492	'=núm de inversores

TABLA DE HERRAJES SEGÚN CONFIGURACIÓN

ESQ	REF	BISAGRAS						CARROS			MANILLAS		PASADORES
		WOOR-9826		WOOR-9826T (1)		WOOR-9827		WOOR-1352	WOOR-1353T	WOOR-1353H	CRAS-0706 (2)	WOOR-1005 (3)	CPAF-1508
		UD. H<1700	UD. H>1700	UD. H<1700	UD. H>1700	UD. H<1700	UD. H>1700	UD.	UD.	UD.	UD. SI APERT. INT.	UD. SI APERT. EXT.	UD.
	P200E2 (2+0)	2	3	0	0	2	3	0	0	1	2	2	0
	P300E3 (3+0)	2	3	0	1	2	3	1	0	0	2	2	0
	P300D1 (2+1)	4	6	0	0	2	3	0	1	0	2	2	0
	P400E4 (4+0)	2	3	0	1	4	6	1	0	1	3	3	0
	P400D1 (3+1)	4	6	0	1	2	3	1	0	0	2	2	1
	P500E5 (5+0)	2	3	0	2	4	6	2	0	0	3	3	0
	P500D1 (4+1)	4	6	0	1	4	6	1	1	0	3	3	0
	P500D2 (3+2)	4	6	0	1	4	6	1	1	0	3	3	0
	P600E6 (6+0)	2	3	0	2	6	9	2	0	1	4	4	0
	P600D1 (5+1)	4	6	0	2	4	6	2	0	0	3	3	1
	P600D3 (3+3)	4	6	0	2	4	6	2	0	0	3	3	1

(1) Para hojas de puerta se utiliza WOOR-9827H.

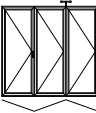
(2) Conjunto manillas APERTURA INTERIOR compuesto por CRAS-07016 + CRAS-1760D/E + CRAS-9232

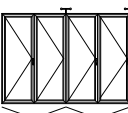
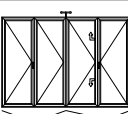
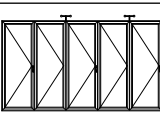
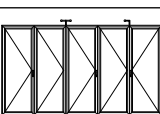
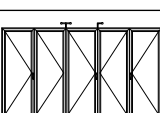
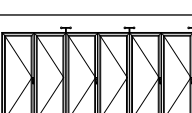
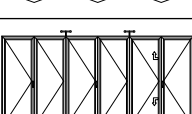
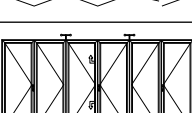
(3) Conjunto manillas APERTURA EXTERIOR compuesto por WOOR-1005 + CPAF-0651 + CPAO-9233

TABLA DE HERRAJES SEGÚN CONFIGURACIÓN

ESQ	REF	BISAGRAS						CARROS			MANILLAS		PASADORES
		WOOR-9826		WOOR-9826T (1)		WOOR-9827		WOOR-1352	WOOR-1353T	WOOR-1353H	CRAS-0706 (2)	WOOR-1005 (3)	CPAF-1508
		UD. H<1700	UD. H>1700	UD. H<1700	UD. H>1700	UD. H<1700	UD. H>1700	UD.	UD.	UD.	UD. SI APERT. INT.	UD. SI APERT. EXT.	UD.
	P700E7 (7+0)	2	3	0	3	6	9	3	0	0	4	4	0
	P700D1 (6+1)	4	6	0	2	6	9	2	1	0	4	4	0
	P700D2 (5+2)	4	6	0	2	6	9	2	1	0	4	4	0
	P700D3 (4+3)	4	6	0	2	6	9	2	1	0	4	4	0
	P900E9 (9+0)	2	3	0	4	8	12	4	0	0	5	5	0
	P900D1 (8+1)	4	6	0	3	8	12	3	1	0	5	5	0
	P900D2 (7+2)	4	6	0	3	8	12	3	1	0	5	5	0
	P900D3 (6+3)	4	6	0	3	8	12	3	1	0	5	5	0
	P900D4 (5+4)	4	6	0	3	8	12	3	1	0	5	5	0

(1) Para hojas de puerta se utiliza WOOR-9827H.
 (2) Conjunto manillas APERTURA INTERIOR compuesto por CRAS-07016 + CRAS-1760D/E + CRAS-9232
 (3) Conjunto manillas APERTURA EXTERIOR compuesto por WOOR-1005 + CPAF-0651 + CPAO-9233

PLEGABLE APERTURA INTERIOR P200E2 (2 + 0)
MEDIDAS DE CORTE HOJAS Y MEDIDAS DE CRISTALES
PF43 ALFIL 45 HOJAS SISTEMA

	PF43-1190	PF43-1360/1990	PF43-1960/1990
--	-----------	----------------	----------------

MEDIDAS DE CORTE

FB1	(L/2)-9,1 mm	(L/2)-9,1 mm	(L/2)-9,1 mm
FB4	(L/2)-72,4 mm	(L/2)-72,4 mm	(L/2)-72,4 mm

MEDIDAS DE CRISTALES

FB1	(L/2)-121,5 mm	(L/2)-171,5 mm	(L/2)-201,1 mm
FB4	(L/2)-184,8 mm	(L/2)-234,8 mm	(L/2)-264,4 mm

PT45 / PT54 / PT80 HOJAS SISTEMA

	PTXX-1170 / 1190	PTXX-1360 / 1390	PTXX-1990
--	------------------	------------------	-----------

MEDIDAS DE CORTE

FB1	(L/2)-15,1 mm	(L/2)-15,1 mm	(L/2)-15,1 mm
FB4	(L/2)-78,4 mm	(L/2)-78,4 mm	(L/2)-78,4 mm

MEDIDAS DE CRISTALES

FB1	(L/2)-127,1 mm	(L/2)-177,5 mm	(L/2)-201,1 mm
FB4	(L/2)-190,4 mm	(L/2)-240,8 mm	(L/2)-264,4 mm



GROSOR HOJAS PLEGADAS

	PF43	PT45	PT54	PT80
X	163 mm	169,2 mm	187,6 mm	239,2 mm
Y	65,5 mm	71,7 mm	71,7 mm	75,5 mm

PESOS MÁXIMOS RECOMENDADOS POR HOJA

Tipología plegable (*)	ANCHURA / DIMENSIÓN HOJA			
	800 mm	700 mm	600 mm	500 mm
P200E2 (2 + 0) kg/hoja	55	60	70	75

(*) Para alturas mayores de 1800 mm recomendable utilizar hojas de puerta

LEYENDA:  Manilla  Pasador hoja pasiva  Carros superiores

(1) Para hojas apertura exterior utilizar WOOR-1005 + CPAF-0651 + CPA0-9232

(2) Para hojas de puerta utilizaremos WOOR-9827H

ACCESORIOS SISTEMA

	REF	UD	H<1700 MM	H>1700 MM
MANILLAS (1)	CRAS-0760	2		
	CRAS-1760D / E	2		
	CRAS-9232	2		
PASADORES	CPAF-1508	0		
BISAGRAS	WOOR-9826		2	3
	WOOR-9826T		0	0
	WOOR-9827 (2)		2	3
JUEGO CARROS	WOOR-1352	0		
	WOOR-1352T	0		
	WOOR-1352H	1		

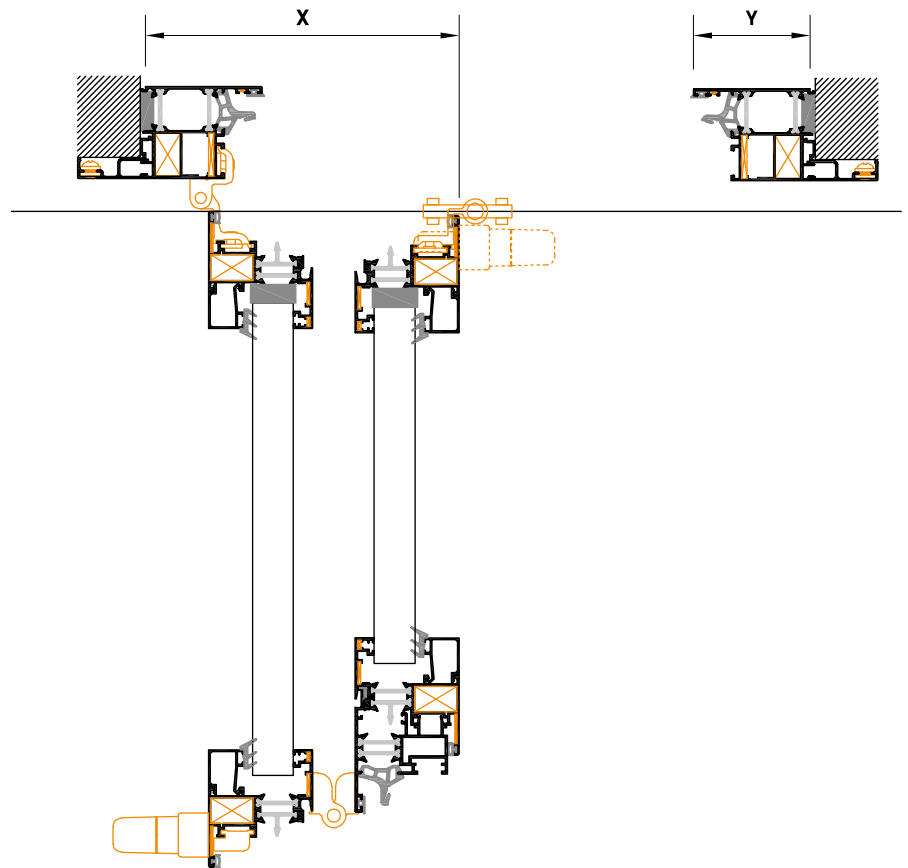
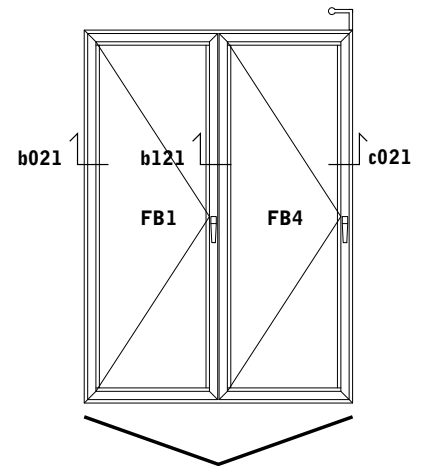

PLE
22

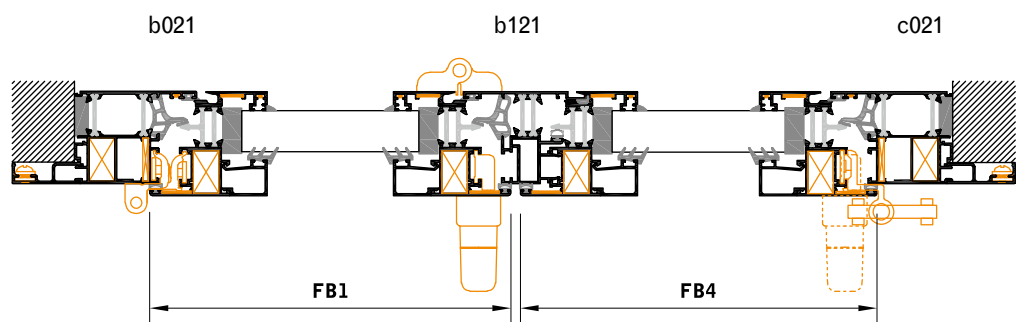



PLEGABLE APERTURA INTERIOR P300E3 (3 + 0)

MEDIDAS DE CORTE HOJAS Y MEDIDAS DE CRISTALES

PF43 ALFIL 45 HOJAS SISTEMA

	PF43-1190	PF43-1360/1990	PF43-1960/1990
--	-----------	----------------	----------------

MEDIDAS DE CORTE

FB1	(L/3)-3,8 mm	(L/3)-3,8 mm	(L/3)-3,8 mm
FB2	(L/3)-78,1 mm	(L/3)-78,1 mm	(L/3)-78,1 mm

MEDIDAS DE CRISTALES

FB1	(L/3)-116,2 mm	(L/3)-166,2 mm	(L/3)-193,8 mm
FB2	(L/3)-190,5 mm	(L/3)-240,5 mm	(L/3)-268,1 mm

PT45 / PT54 / PT80 HOJAS SISTEMA

	PTXX-1170 / 1190	PTXX-1360 / 1390	PTXX-1990
--	------------------	------------------	-----------

MEDIDAS DE CORTE

FB1	(L/3)-7,8 mm	(L/3)-7,8 mm	(L/3)-7,8 mm
FB2	(L/3)-82,1 mm	(L/3)-82,1 mm	(L/3)-82,1 mm

MEDIDAS DE CRISTALES

FB1	(L/3)-119,8 mm	(L/3)-170,2 mm	(L/3)-193,8 mm
FB2	(L/3)-194,1 mm	(L/3)-244,5 mm	(L/3)-268,1 mm



GROSOR HOJAS PLEGADAS

	PF43	PT45	PT54	PT80
X	240,1 mm	246,3 mm	273,9 mm	351,3 mm
Y	65,5 mm	71,7 mm	71,7 mm	75,5 mm

PESOS MÁXIMOS RECOMENDADOS POR HOJA

	ANCHURA / DIMENSIÓN HOJA			
Tipología plegable (*)	800 mm	700 mm	600 mm	500 mm
P300E3 (3 + 0) kg/hoja	35	45	50	55

(*) Para alturas mayores de 1800 mm recomendable utilizar hojas de puerta

LEYENDA:  Manilla  Pasador hoja pasiva  Carros superiores

(1) Para hojas apertura exterior utilizar WOOR-1005 + CPAF-0651 + CPA0-9232
 (2) Para hojas de puerta utilizaremos WOOR-9827H

ACCESORIOS SISTEMA

	REF	UD	H<1700 MM	H>1700 MM
MANILLAS (1)	CRAS-0760	2		
	CRAS-1760D / E	2		
	CRAS-9232	2		
PASADORES	CPAF-1508	0		
BISAGRAS	WOOR-9826		2	3
	WOOR-9826T		0	1
	WOOR-9827 (2)		2	3
JUEGO CARROS	WOOR-1352	1		
	WOOR-1352T	0		
	WOOR-1352H	0		

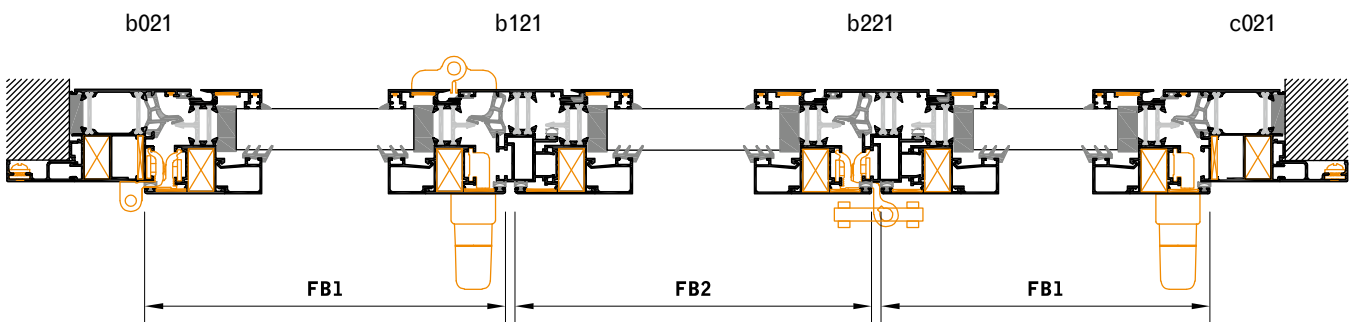
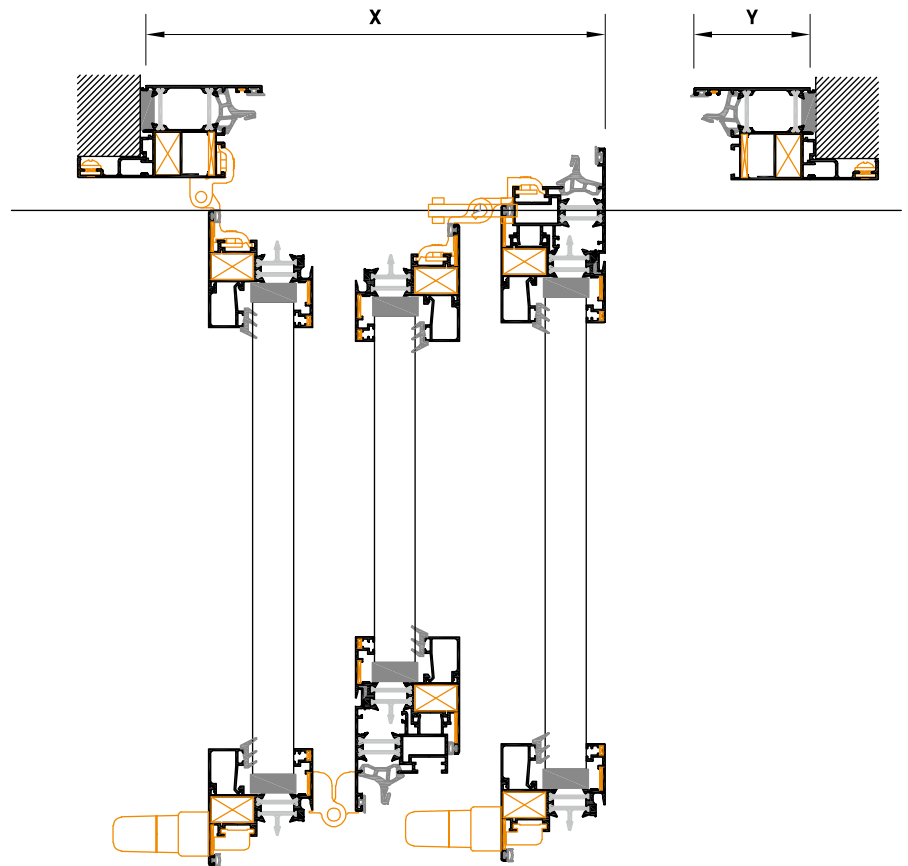
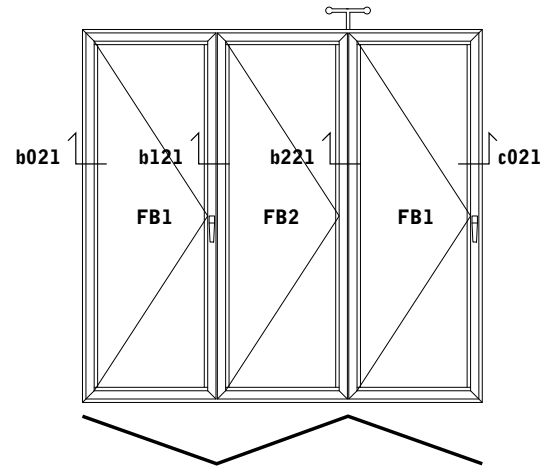

PLEGABLE APERTURA INTERIOR P300D1 (2 + 1)
MEDIDAS DE CORTE HOJAS Y MEDIDAS DE CRISTALES
PF43 ALFIL 45 HOJAS SISTEMA

	PF43-1190	PF43-1360/1990	PF43-1960/1990
--	-----------	----------------	----------------

MEDIDAS DE CORTE

FB1	(L/3)-7,7 mm	(L/3)-7,7 mm	(L/3)-7,7 mm
FB4	(L/3)-71 mm	(L/3)-71 mm	(L/3)-71 mm

MEDIDAS DE CRISTALES

FB1	(L/3)-120,1 mm	(L/3)-170,1 mm	(L/3)-197,7 mm
FB4	(L/3)-183,4 mm	(L/3)-233,4 mm	(L/3)-261 mm

PT45 / PT54 / PT80 HOJAS SISTEMA

	PTXX-1170 / 1190	PTXX-1360 / 1390	PTXX-1990
--	------------------	------------------	-----------

MEDIDAS DE CORTE

FB1	(L/3)-11,7 mm	(L/3)-11,7 mm	(L/3)-11,7 mm
FB4	(L/3)-75 mm	(L/3)-75 mm	(L/3)-75 mm

MEDIDAS DE CRISTALES

FB1	(L/3)-123,7 mm	(L/3)-174,1 mm	(L/3)-197,7 mm
FB4	(L/3)-187 mm	(L/3)-237,4 mm	(L/3)-261 mm



GROSOR HOJAS PLEGADAS

	PF43	PT45	PT54	PT80
X	163 mm	169,2 mm	187,6 mm	239,2 mm
Y	85,9 mm	92,1 mm	101,3 mm	127,1 mm

PESOS MÁXIMOS RECOMENDADOS POR HOJA

	ANCHURA / DIMENSIÓN HOJA			
Tipología plegable (*)	800 mm	700 mm	600 mm	500 mm
P300D1 (2 + 1) kg/hoja	55	60	70	75

(*) Para alturas mayores de 1800 mm recomendable utilizar hojas de puerta

 LEYENDA:  Manilla  Pasador hoja pasiva  Carros superiores

(1) Para hojas apertura exterior utilizar WOOR-1005 + CPAF-0651 + CPA0-9232

(2) Para hojas de puerta utilizaremos WOOR-9827H

ACCESORIOS SISTEMA

	REF	UD	H<1700 MM	H>1700 MM
	CRAS-0760	2		
MANILLAS (1)	CRAS-1760D / E	2		
	CRAS-9232	2		
PASADORES	CPAF-1508	0		
	WOOR-9826		4	6
BISAGRAS	WOOR-9826T		0	0
	WOOR-9827 (2)		2	3
	WOOR-1352	0		
JUEGO CARROS	WOOR-1352T	1		
	WOOR-1352H	0		

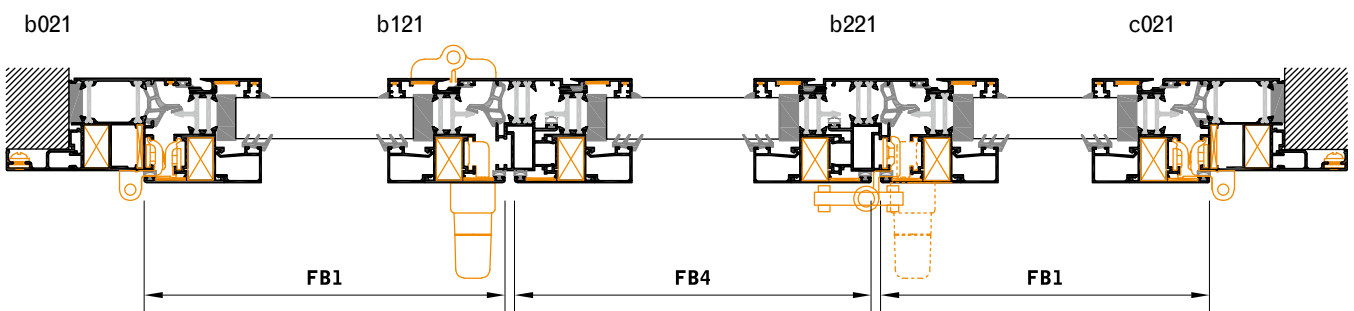
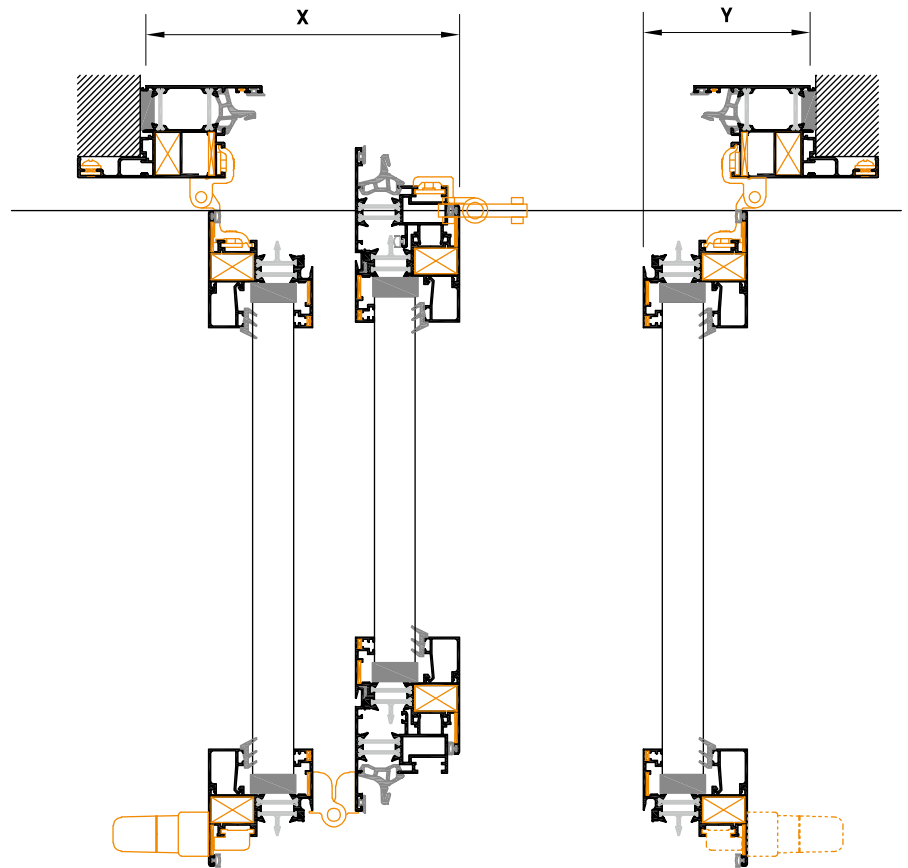
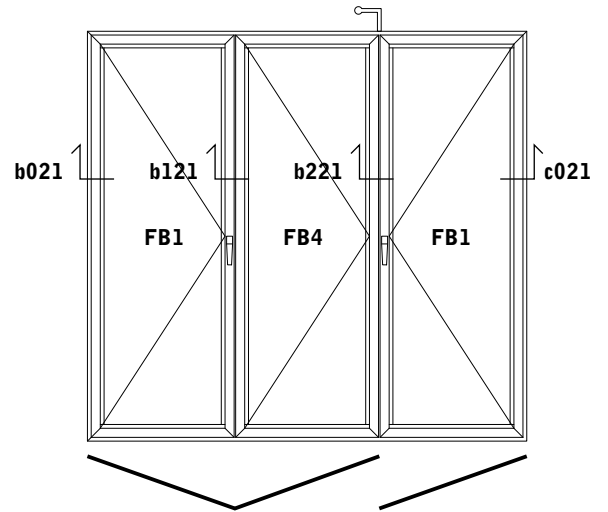



PLEGABLE APERTURA INTERIOR P400E4 (4 + 0)

MEDIDAS DE CORTE HOJAS Y MEDIDAS DE CRISTALES
PF43 ALFIL 45 HOJAS SISTEMA

	PF43-1190	PF43-1360/1990	PF43-1960/1990
--	-----------	----------------	----------------

MEDIDAS DE CORTE

FB1	(L/4)+13,5 mm	(L/4)+13,5 mm	(L/4)+13,5 mm
FB2	(L/4)-60,8 mm	(L/4)-60,8 mm	(L/4)-60,8 mm
FB3	(L/4)+16,4 mm	(L/4)+16,4 mm	(L/4)+16,4 mm

MEDIDAS DE CRISTALES

FB1	(L/4)-98,9 mm	(L/4)-148,9 mm	(L/4)-175,5 mm
FB2	(L/4)-173,2 mm	(L/4)-223,2 mm	(L/4)-249,8 mm
FB3	(L/4)-96 mm	(L/4)-146 mm	(L/4)-149 mm

PT45 / PT54 / PT80 HOJAS SISTEMA

	PTXX-1170 / 1190	PTXX-1360 / 1390	PTXX-1990
--	------------------	------------------	-----------

MEDIDAS DE CORTE

FB1	(L/4)+10,5 mm	(L/4)+10,5 mm	(L/4)+10,5 mm
FB2	(L/4)-63,8 mm	(L/4)-63,8 mm	(L/4)-63,8 mm
FB3	(L/4)+13,4 mm	(L/4)+13,4 mm	(L/4)+13,4 mm

MEDIDAS DE CRISTALES

FB1	(L/4)-101,5 mm	(L/4)-151,9 mm	(L/4)-175,5 mm
FB2	(L/4)-175,8 mm	(L/4)-226,2 mm	(L/4)-249,8 mm
FB3	(L/4)-98,6 mm	(L/4)-123,2 mm	(L/4)-149 mm



GROSOR HOJAS PLEGADAS

	PF43	PT45	PT54	PT80
X	317,2 mm	323,4 mm	360,2 mm	463,4 mm
Y	65,5 mm	71,7 mm	71,7 mm	75,5 mm

PESOS MÁXIMOS RECOMENDADOS POR HOJA

Tipología plegable (*)	ANCHURA / DIMENSIÓN HOJA			
	800 mm	700 mm	600 mm	500 mm
P400E4 (4 + 0) kg/hoja	40	55	60	65

(*) Para alturas mayores de 1800 mm recomendable utilizar hojas de puerta

LEYENDA:  Manilla  Pasador hoja pasiva  Carros superiores

(1) Para hojas apertura exterior utilizar WOOR-1005 + CPAF-0651 + CPA0-9232

(2) Para hojas de puerta utilizaremos WOOR-9827H

ACCESORIOS SISTEMA

	REF	UD	H<1700 MM	H>1700 MM
	CRAS-0760	3		
MANILLAS (1)	CRAS-1760D / E	3		
	CRAS-9232	3		
PASADORES	CPAF-1508	0		
BISAGRAS	WOOR-9826		2	3
	WOOR-9826T		0	1
	WOOR-9827 (2)		4	6
JUEGO CARROS	WOOR-1352	1		
	WOOR-1352T	0		
	WOOR-1352H	1		

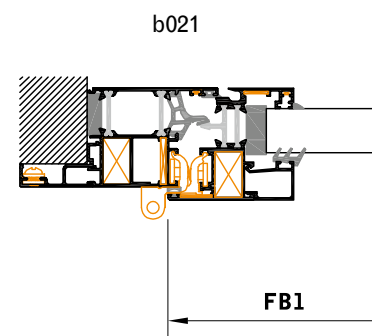

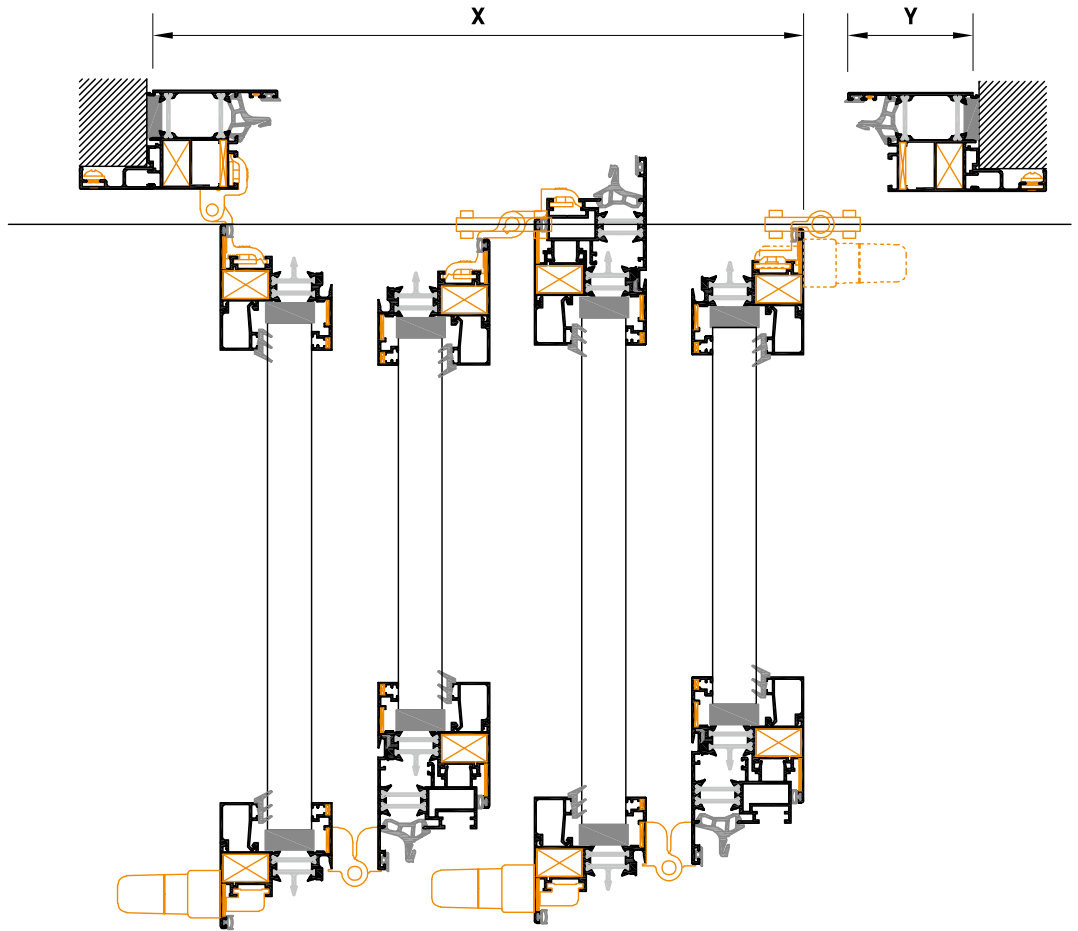
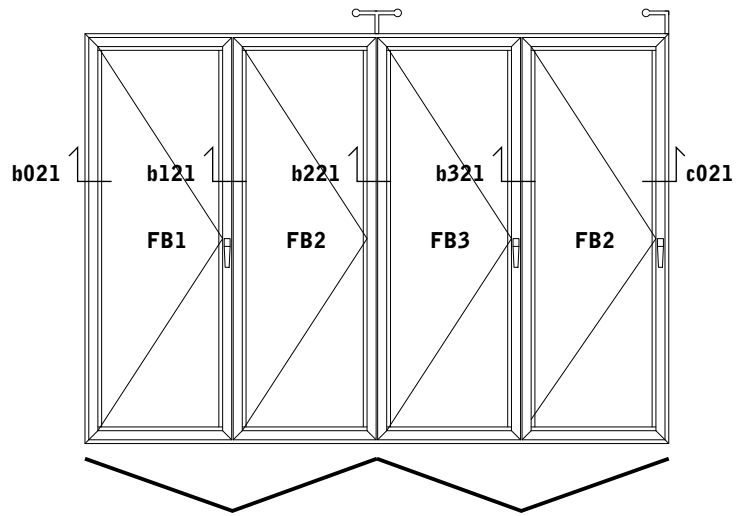

PLE
28

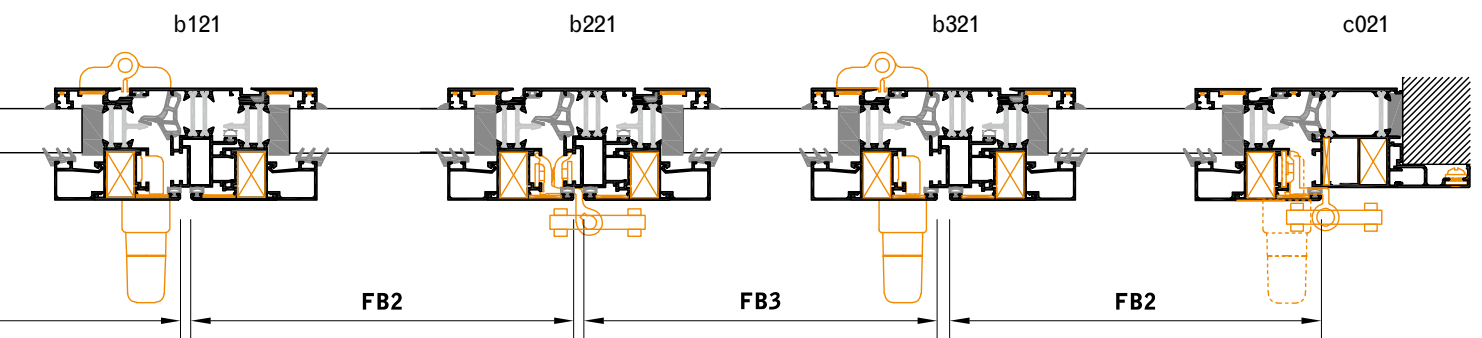



PLEGABLE APERTURA INTERIOR P400D1 (3 + 1)

MEDIDAS DE CORTE HOJAS Y MEDIDAS DE CRISTALES
PF43 ALFIL 45 HOJAS SISTEMA

	PF43-1190	PF43-1360/1990	PF43-1960/1990
--	-----------	----------------	----------------

MEDIDAS DE CORTE

FB1	(L/4)-4,8 mm	(L/4)-4,8 mm	(L/4)-4,8 mm
FB2	(L/4)-79,1 mm	(L/4)-79,1 mm	(L/4)-79,1 mm
FB3	(L/4)-1,9 mm	(L/4)-1,9 mm	(L/4)-1,9 mm

MEDIDAS DE CRISTALES

FB1	(L/4)-117,2 mm	(L/4)-167,2 mm	(L/4)-193,8 mm
FB2	(L/4)-191,5 mm	(L/4)-241,5 mm	(L/4)-268,1 mm
FB3	(L/4)-114,3 mm	(L/4)-164,3 mm	(L/4)-167,3 mm

PT45 / PT54 / PT80 HOJAS SISTEMA

	PTXX-1170 / 1190	PTXX-1360 / 1390	PTXX-1990
--	------------------	------------------	-----------

MEDIDAS DE CORTE

FB1	(L/4)-7,8 mm	(L/4)-7,8 mm	(L/4)-7,8 mm
FB2	(L/4)-82,1 mm	(L/4)-82,1 mm	(L/4)-82,1 mm
FB3	(L/4)-4,9 mm	(L/4)-4,9 mm	(L/4)-4,9 mm

MEDIDAS DE CRISTALES

FB1	(L/4)-119,8 mm	(L/4)-170,2 mm	(L/4)-193,8 mm
FB2	(L/4)-194,1 mm	(L/4)-244,5 mm	(L/4)-268,1 mm
FB3	(L/4)-116,9 mm	(L/4)-141,5 mm	(L/4)-167,3 mm



GROSOR HOJAS PLEGADAS

	PF43	PT45	PT54	PT80
X	240,1 mm	246,3 mm	273,9 mm	351,3 mm
Y	85,9 mm	92,1 mm	101,3 mm	127,1 mm

PESOS MÁXIMOS RECOMENDADOS POR HOJA

Tipología plegable (*)	ANCHURA / DIMENSIÓN HOJA			
	800 mm	700 mm	600 mm	500 mm
P400D1 (3 + 1) kg/hoja	35	45	50	55

(*) Para alturas mayores de 1800 mm recomendable utilizar hojas de puerta

LEYENDA:  Manilla  Pasador hoja pasiva  Carros superiores

(1) Para hojas apertura exterior utilizar WOOR-1005 + CPAF-0651 + CPA0-9232

(2) Para hojas de puerta utilizaremos WOOR-9827H

ACCESORIOS SISTEMA

	REF	UD	H<1700 MM	H>1700 MM
	CRAS-0760	2		
MANILLAS (1)	CRAS-1760D / E	2		
	CRAS-9232	2		
PASADORES	CPAF-1508	1		
BISAGRAS	WOOR-9826		4	6
	WOOR-9826T		0	1
	WOOR-9827 (2)		2	3
JUEGO CARROS	WOOR-1352	1		
	WOOR-1352T	0		
	WOOR-1352H	0		

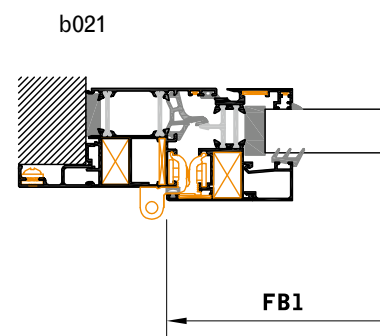

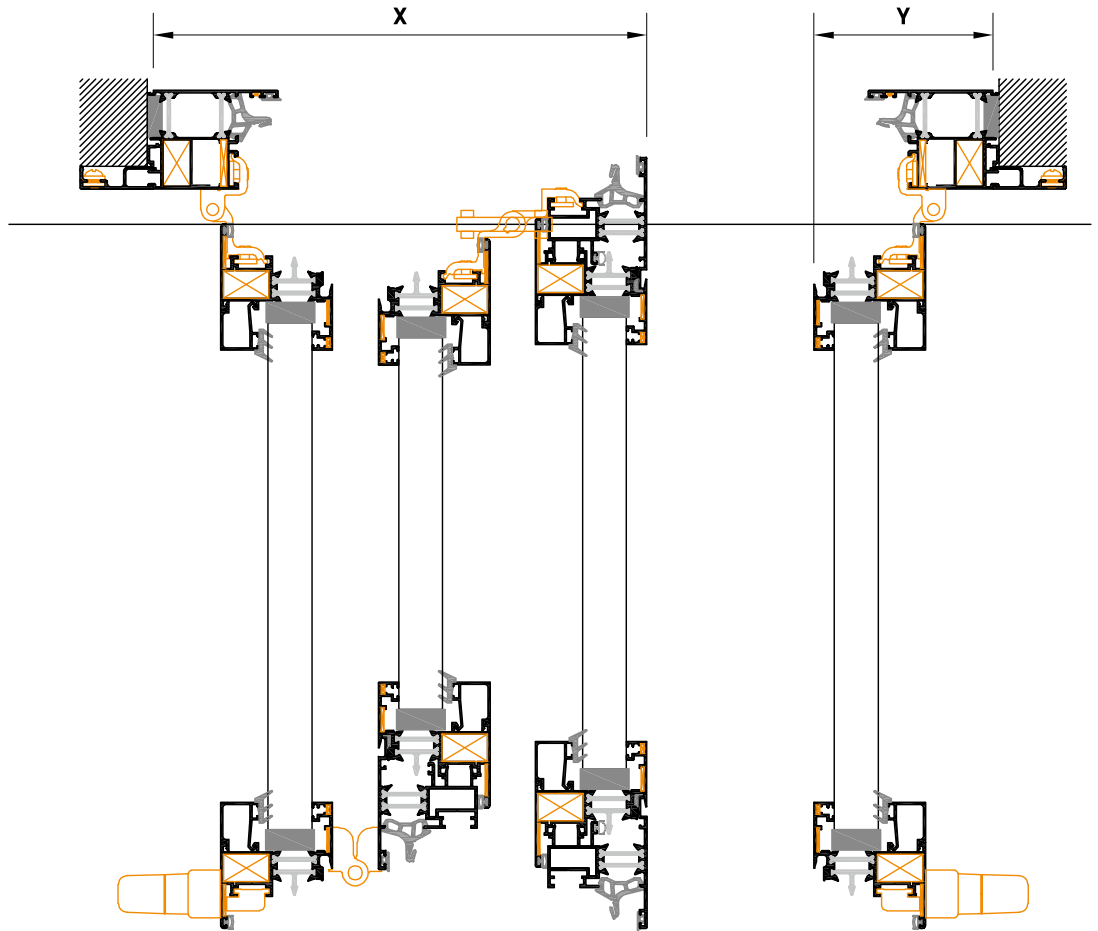
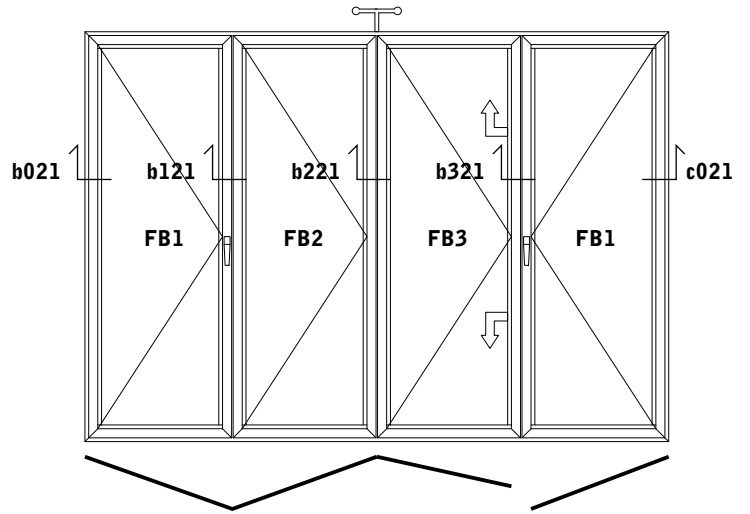

PLE
30

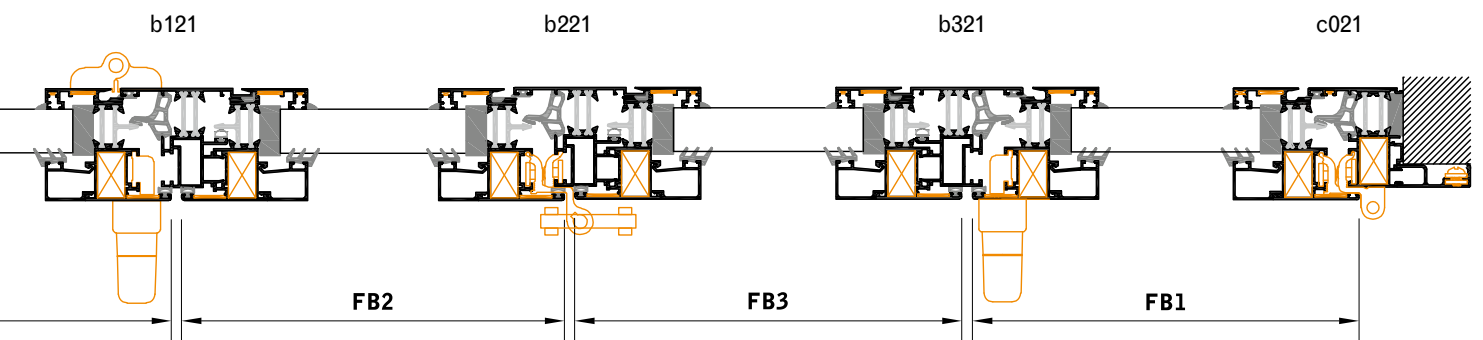



PLEGABLE APERTURA EXTERIOR P500E5 (5 + 0)

MEDIDAS DE CORTE HOJAS Y MEDIDAS DE CRISTALES
PF43 ALFIL 45 HOJAS SISTEMA

	PF43-1190	PF43-1360/1990	PF43-1960/1990
MEDIDAS DE CORTE			
FB1	(L/5)+10 mm	(L/5)+10 mm	(L/5)+10 mm
FB2	(L/5)-64,3 mm	(L/5)-64,3 mm	(L/5)-64,3 mm
FB3	(L/5)+12,9 mm	(L/5)+12,9 mm	(L/5)+12,9 mm
MEDIDAS DE CRISTALES			
FB1	(L/5)+10 mm	(L/5)+10 mm	(L/5)+10 mm
FB2	(L/5)-64,3 mm	(L/5)-64,3 mm	(L/5)-64,3 mm
FB3	(L/5)+12,9 mm	(L/5)+12,9 mm	(L/5)+12,9 mm

PT45 / PT54 / PT80 HOJAS SISTEMA

	PTXX-1170 / 1190	PTXX-1360 / 1390	PTXX-1990
MEDIDAS DE CORTE			
FB1	(L/5)+7,6 mm	(L/5)+7,6 mm	(L/5)+7,6 mm
FB2	(L/5)-66,7 mm	(L/5)-66,7 mm	(L/5)-66,7 mm
FB3	(L/5)+10,5 mm	(L/5)+10,5 mm	(L/5)+10,5 mm
MEDIDAS DE CRISTALES			
FB1	(L/5)-104,4 mm	(L/5)-154,8 mm	(L/5)-178,4 mm
FB2	(L/5)-178,7 mm	(L/5)-229,1 mm	(L/5)-252,7 mm
FB3	(L/5)-101,5 mm	(L/5)-126,1 mm	(L/5)-151,9 mm

GROSOR HOJAS PLEGADAS

	PF43	PT45	PT54	PT80
X	394,3 mm	400,5 mm	446,5 mm	575,5 mm
Y	65,5 mm	71,7 mm	71,7 mm	75,5 mm

PESOS MÁXIMOS RECOMENDADOS POR HOJA
ANCHURA / DIMENSIÓN HOJA

Tipología plegable (*)	800 mm	700 mm	600 mm	500 mm
P500E5 (5 + 0) kg/hoja	25	35	45	50

(*) Para alturas mayores de 1800 mm recomendable utilizar hojas de puerta

LEYENDA: Manilla Pasador hoja pasiva Carros superiores
(3) Para hojas apertura interior utilizar CRAS-0760 + CRAS-1760D/E + CRAS-9232
(4) Para hojas de ventana utilizaremos WOOR-9827

ACCESORIOS SISTEMA

	REF	UD	H<1700 MM	H>1700 MM
MANILLAS (1)	WOOR-1005	3		
	CPAF-0651	3		
	CPAF-9232	3		
PASADORES	CPAF-1508	0		
BISAGRAS	WOOR-9826		2	3
	WOOR-9826T		0	2
	WOOR-9827H (4)		4	6
JUEGO CARROS	WOOR-1352	2		
	WOOR-1352T	0		
	WOOR-1352H	0		

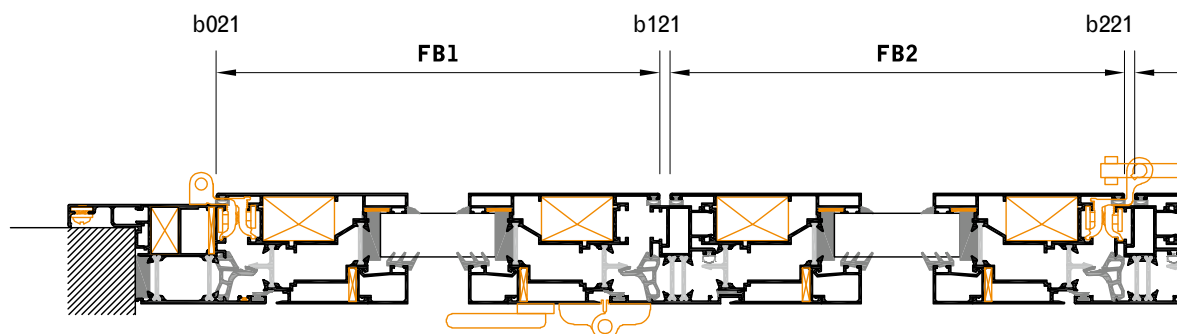

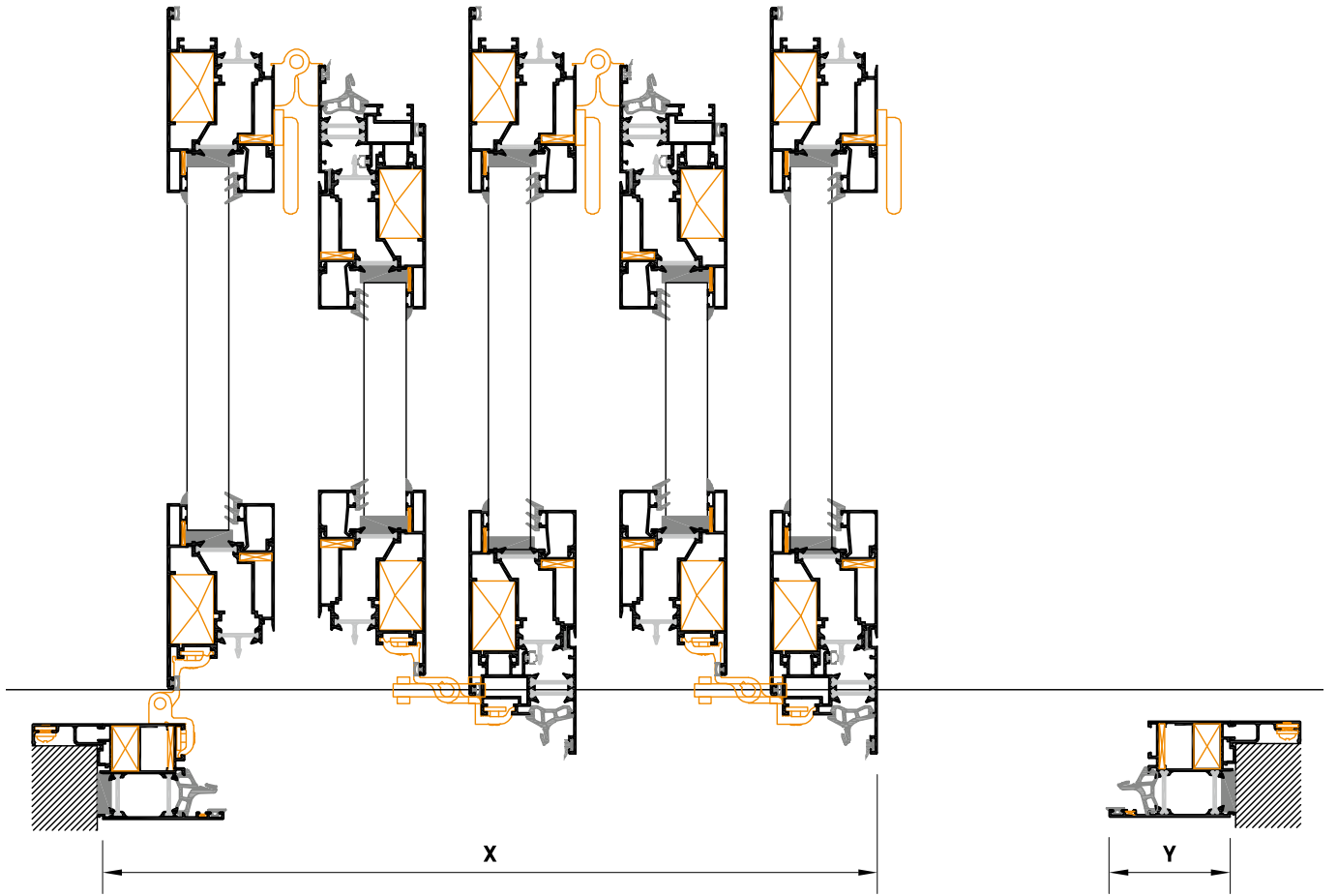
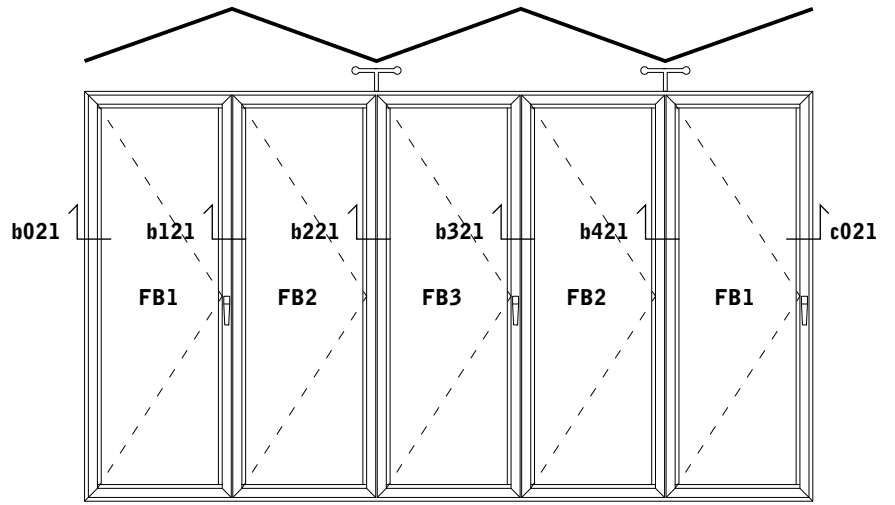

PLE
32

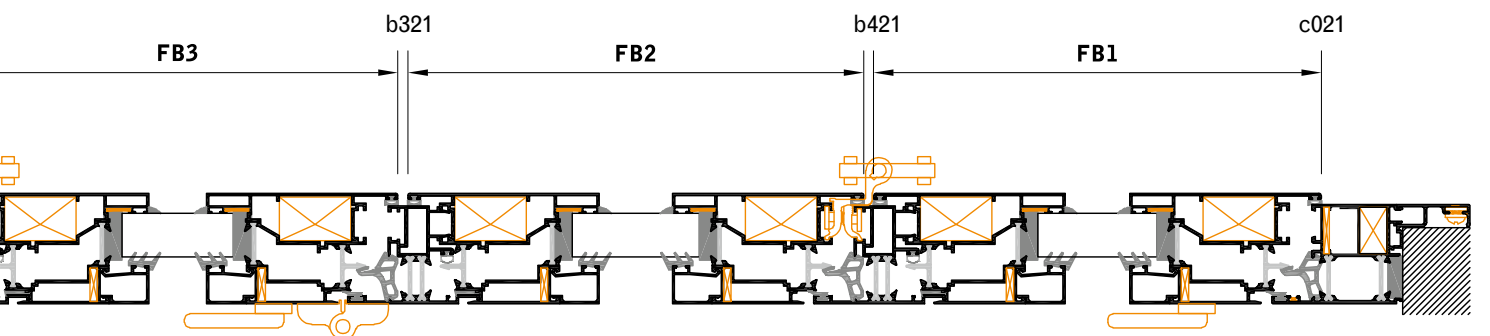



PLEGABLE APERTURA EXTERIOR P500D1 (4 + 1)

MEDIDAS DE CORTE HOJAS Y MEDIDAS DE CRISTALES
PF43 ALFIL 45 HOJAS SISTEMA

	PF43-1190	PF43-1360/1990	PF43-1960/1990
MEDIDAS DE CORTE			
FB1	(L/5)+7,6 mm	(L/5)+7,6 mm	(L/5)+7,6 mm
FB2	(L/5)-66,7 mm	(L/5)-66,7 mm	(L/5)-66,7 mm
FB3	(L/5)+10,5 mm	(L/5)+10,5 mm	(L/5)+10,5 mm
FB4	(L/5)-55,7 mm	(L/5)-55,7 mm	(L/5)-55,7 mm
MEDIDAS DE CRISTALES			
FB1	(L/5)-104,8 mm	(L/5)-154,8 mm	(L/5)-180,8 mm
FB2	(L/5)-179,1 mm	(L/5)-229,1 mm	(L/5)-255,7 mm
FB3	(L/5)-101,9 mm	(L/5)-151,9 mm	(L/5)-154,3 mm
FB4	(L/5)-168,1 mm	(L/5)-218,1 mm	(L/5)-220,5 mm

PT45 / PT54 / PT80 HOJAS SISTEMA

	PTXX-1170 / 1190	PTXX-1360 / 1390	PTXX-1990
MEDIDAS DE CORTE			
FB1	(L/5)+5,2 mm	(L/5)+5,2 mm	(L/5)+5,2 mm
FB2	(L/5)-69,7 mm	(L/5)-69,7 mm	(L/5)-69,7 mm
FB3	(L/5)+8,1 mm	(L/5)+8,1 mm	(L/5)+8,1 mm
FB4	(L/5)-58,1 mm	(L/5)-58,1 mm	(L/5)-58,1 mm
MEDIDAS DE CRISTALES			
FB1	(L/5)-106,8 mm	(L/5)-157,2 mm	(L/5)-180,8 mm
FB2	(L/5)-181,7 mm	(L/5)-232,1 mm	(L/5)-255,7 mm
FB3	(L/5)-103,9 mm	(L/5)-128,5 mm	(L/5)-154,3 mm
FB4	(L/5)-170,1 mm	(L/5)-194,7 mm	(L/5)-220,5 mm



GROSOR HOJAS PLEGADAS

	PF43	PT45	PT54	PT80
X	317,2 mm	323,4 mm	360,2 mm	463,4 mm
Y	85,9 mm	92,1 mm	101,3 mm	127,1 mm

PESOS MÁXIMOS RECOMENDADOS POR HOJA

Tipología plegable (*)	ANCHURA / DIMENSIÓN HOJA			
	800 mm	700 mm	600 mm	500 mm
P500D1 (4 + 1) kg/hoja	40	55	60	65

(*) Para alturas mayores de 1800 mm recomendable utilizar hojas de puerta

LEYENDA:  Manilla  Pasador hoja pasiva  Carros superiores
 (3) Para hojas apertura interior utilizar CRAS-0760 + CRAS-1760D/E + CRAS-9232
 (4) Para hojas de ventana utilizaremos WOOR-9827

ACCESORIOS SISTEMA

	REF	UD	H<1700 MM	H>1700 MM
MANILLAS (1)	WOOR-1005	3		
	CPAF-0651	3		
	CPAF-9232	3		
PASADORES	CPAF-1508	0		
BISAGRAS	WOOR-9826		4	6
	WOOR-9826T		0	1
	WOOR-9827H (4)		4	6
JUEGO CARROS	WOOR-1352	1		
	WOOR-1352T	1		
	WOOR-1352H	0		

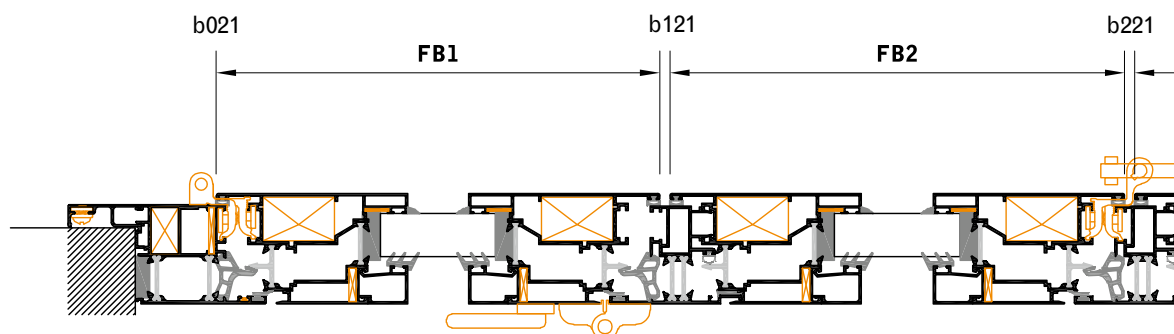

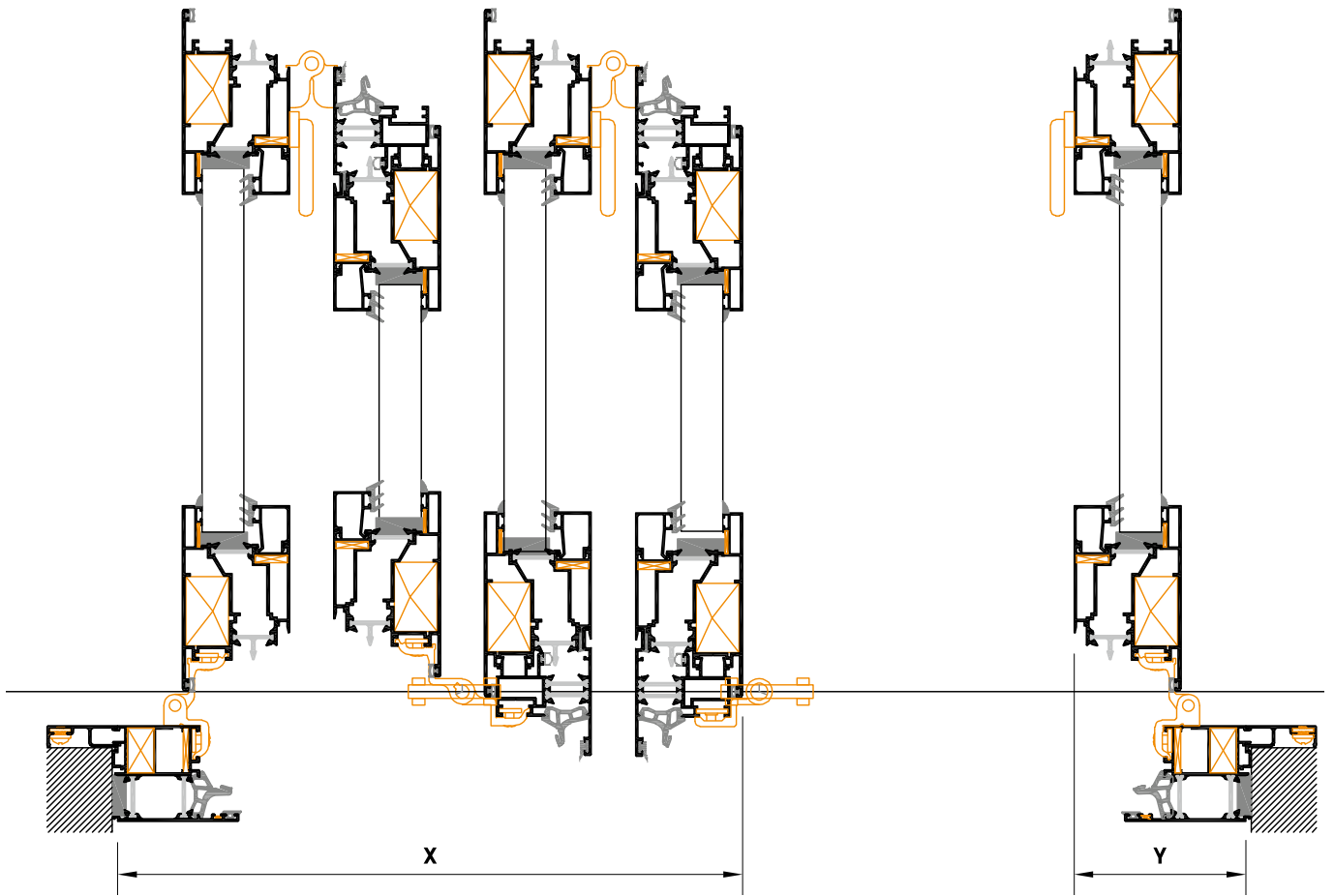
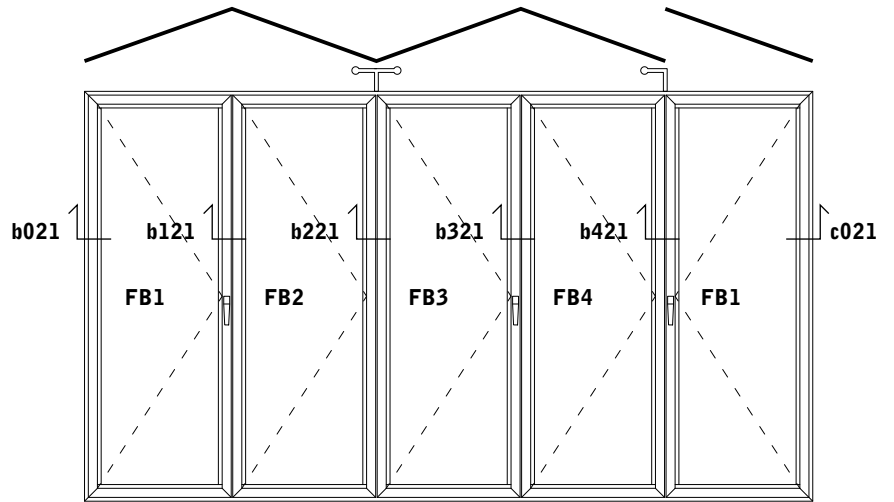

PLE
34

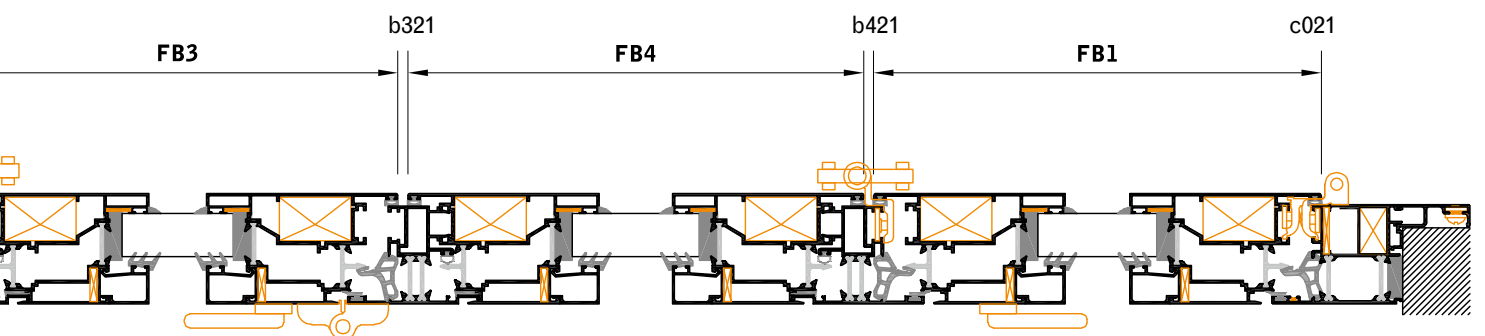

PLEGABLE APERTURA EXTERIOR P500D2 (3 + 2)

MEDIDAS DE CORTE HOJAS Y MEDIDAS DE CRISTALES

PF43 ALFIL 45 HOJAS SISTEMA

	PF43-1190	PF43-1360/1990	PF43-1960/1990
MEDIDAS DE CORTE			
FB1	(L/5)+7,6 mm	(L/5)+7,6 mm	(L/5)+7,6 mm
FB2	(L/5)-66,7 mm	(L/5)-66,7 mm	(L/5)-66,7 mm
FB3	(L/5)+10,5 mm	(L/5)+10,5 mm	(L/5)+10,5 mm
FB4	(L/5)-55,7 mm	(L/5)-55,7 mm	(L/5)-55,7 mm
MEDIDAS DE CRISTALES			
FB1	(L/5)-104,8 mm	(L/5)-154,8 mm	(L/5)-180,8 mm
FB2	(L/5)-179,1 mm	(L/5)-229,1 mm	(L/5)-255,7 mm
FB3	(L/5)-101,9 mm	(L/5)-151,9 mm	(L/5)-154,3 mm
FB4	(L/5)-168,1 mm	(L/5)-218,1 mm	(L/5)-220,5 mm

PT45 / PT54 / PT80 HOJAS SISTEMA

	PTXX-1170 / 1190	PTXX-1360 / 1390	PTXX-1990
MEDIDAS DE CORTE			
FB1	(L/5)+5,2 mm	(L/5)+5,2 mm	(L/5)+5,2 mm
FB2	(L/5)-69,7 mm	(L/5)-69,7 mm	(L/5)-69,7 mm
FB3	(L/5)+8,1 mm	(L/5)+8,1 mm	(L/5)+8,1 mm
FB4	(L/5)-58,1 mm	(L/5)-58,1 mm	(L/5)-58,1 mm
MEDIDAS DE CRISTALES			
FB1	(L/5)-106,8 mm	(L/5)-157,2 mm	(L/5)-180,8 mm
FB2	(L/5)-181,7 mm	(L/5)-232,1 mm	(L/5)-255,7 mm
FB3	(L/5)-103,9 mm	(L/5)-128,5 mm	(L/5)-154,3 mm
FB4	(L/5)-170,1 mm	(L/5)-194,7 mm	(L/5)-220,5 mm



GROSOR HOJAS PLEGADAS

	PF43	PT45	PT54	PT80
X	240,1 mm	246,3 mm	273,9 mm	351,3 mm
Y	163 mm	169,2 mm	187,6 mm	239,2 mm

PESOS MÁXIMOS RECOMENDADOS POR HOJA

Tipología plegable (*)	ANCHURA / DIMENSIÓN HOJA			
	800 mm	700 mm	600 mm	500 mm
P500D2 (3 + 2) kg/hoja	35	45	50	55

(*) Para alturas mayores de 1800 mm recomendable utilizar hojas de puerta

LEYENDA:  Manilla  Pasador hoja pasiva  Carros superiores

(3) Para hojas apertura interior utilizar CRAS-0760 + CRAS-1760D/E + CRAS-9232

(4) Para hojas de ventana utilizaremos WOOR-9827

ACCESORIOS SISTEMA

	REF	UD	H<1700 MM	H>1700 MM
MANILLAS (1)	WOOR-1005	3		
	CPAF-0651	3		
	CPAF-9232	3		
PASADORES	CPAF-1508	0		
BISAGRAS	WOOR-9826		4	6
	WOOR-9826T		0	1
	WOOR-9827H (4)		4	6
JUEGO CARROS	WOOR-1352	1		
	WOOR-1352T	1		
	WOOR-1352H	0		

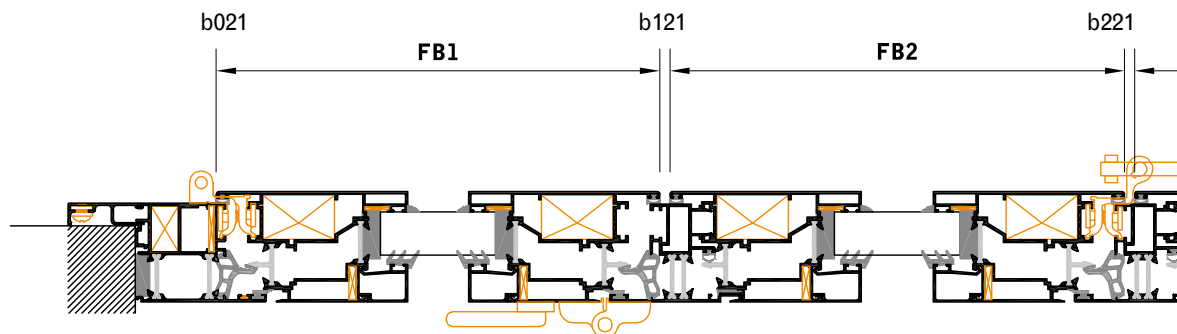

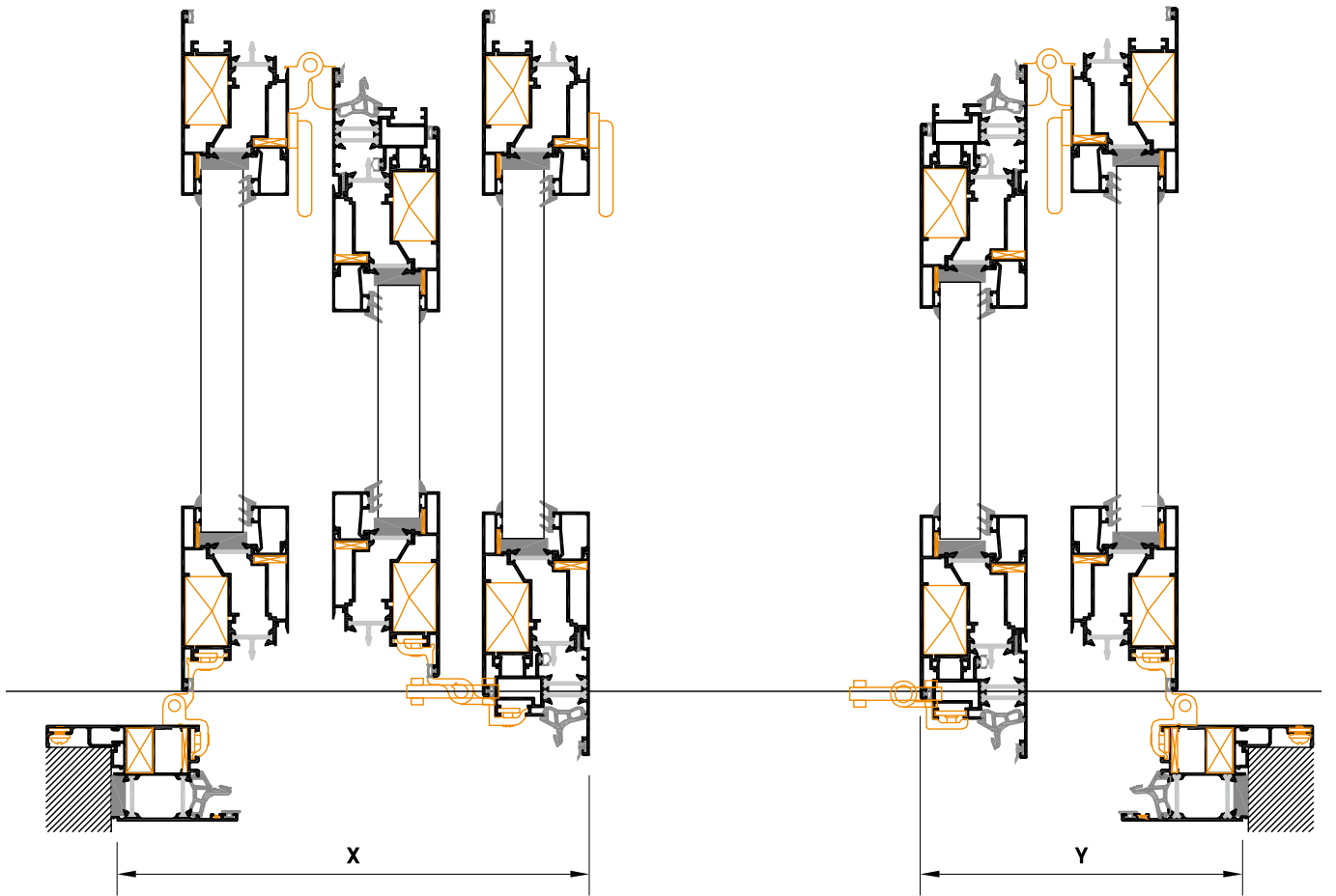
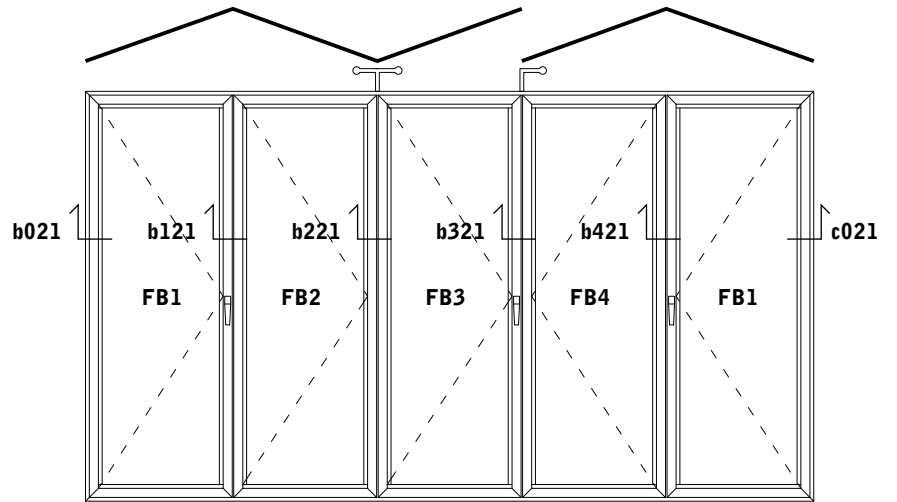

PLE
36

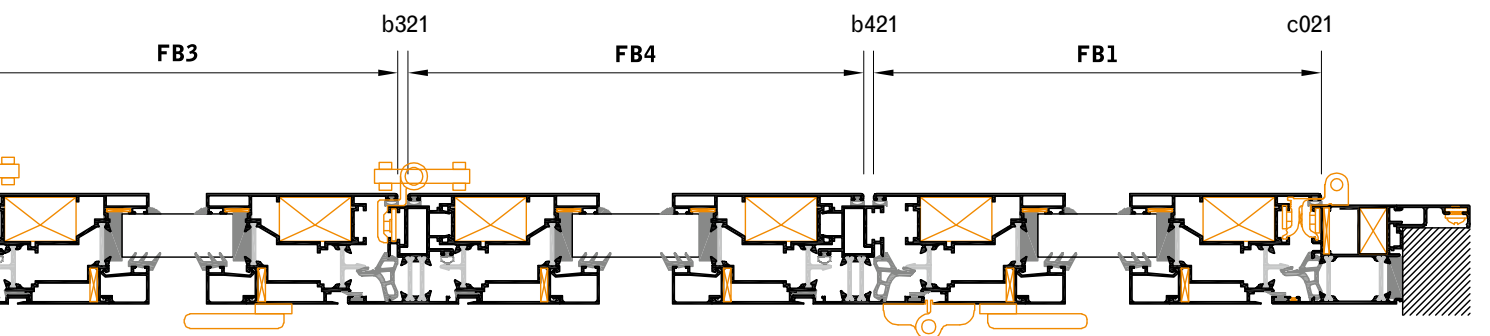



PLEGABLE APERTURA INTERIOR P600E6 (6 + 0)

MEDIDAS DE CORTE HOJAS Y MEDIDAS DE CRISTALES

PF43 ALFIL 45 HOJAS SISTEMA

	PF43-1190	PF43-1360/1990	PF43-1960/1990
--	-----------	----------------	----------------

MEDIDAS DE CORTE

FB1	(L/6)+19,2 mm	(L/6)+19,2 mm	(L/6)+19,2 mm
FB2	(L/6)-55,1 mm	(L/6)-55,1 mm	(L/6)-55,1 mm
FB3	(L/6)+22,1 mm	(L/6)+22,1 mm	(L/6)+22,1 mm

MEDIDAS DE CRISTALES

FB1	(L/6)-93,2 mm	(L/6)-143,2 mm	(L/6)-168,8 mm
FB2	(L/6)-167,5 mm	(L/6)-217,5 mm	(L/6)-243,1 mm
FB3	(L/6)-90,3 mm	(L/6)-140,3 mm	(L/6)-142,3 mm

PT45 / PT54 / PT80 HOJAS SISTEMA

	PTXX-1170 / 1190	PTXX-1360 / 1390	PTXX-1990
--	------------------	------------------	-----------

MEDIDAS DE CORTE

FB1	(L/6)+17,2 mm	(L/6)+17,2 mm	(L/6)+17,2 mm
FB2	(L/6)-57,1 mm	(L/6)-57,1 mm	(L/6)-57,1 mm
FB3	(L/6)+20,1 mm	(L/6)+20,1 mm	(L/6)+20,1 mm

MEDIDAS DE CRISTALES

FB1	(L/6)-94,8 mm	(L/6)-145,2 mm	(L/6)-168,8 mm
FB2	(L/6)-169,1 mm	(L/6)-219,5 mm	(L/6)-243,1 mm
FB3	(L/6)-91,9 mm	(L/6)-116,5 mm	(L/6)-142,3 mm

GROSOR HOJAS PLEGADAS

	PF43	PT45	PT54	PT80
X	471,4 mm	477,6 mm	532,8 mm	687,6 mm
Y	65,5 mm	71,7 mm	71,7 mm	75,5 mm

PESOS MÁXIMOS RECOMENDADOS POR HOJA

Tipología plegable (*)	ANCHURA / DIMENSIÓN HOJA			
	800 mm	700 mm	600 mm	500 mm
P600E6 (6 + 0) kg/hoja	30	50	55	60

(*) Para alturas mayores de 1800 mm recomendable utilizar hojas de puerta

LEYENDA: Manilla Pasador hoja pasiva Carros superiores

(1) Para hojas apertura exterior utilizar WOOR-1005 + CPAF-0651 + CPA0-9232

(2) Para hojas de puerta utilizaremos WOOR-9827H

ACCESORIOS SISTEMA

	REF	UD	H<1700 MM	H>1700 MM
MANILLAS (1)	CRAS-0760	4		
	CRAS-1760D / E	4		
	CRAS-9232	4		
PASADORES	CPAF-1508	0		
	WOOR-9826		2	3
BISAGRAS	WOOR-9826T		0	2
	WOOR-9827 (2)		6	9
	WOOR-1352		2	
JUEGO CARROS	WOOR-1352T	0		
	WOOR-1352H	1		

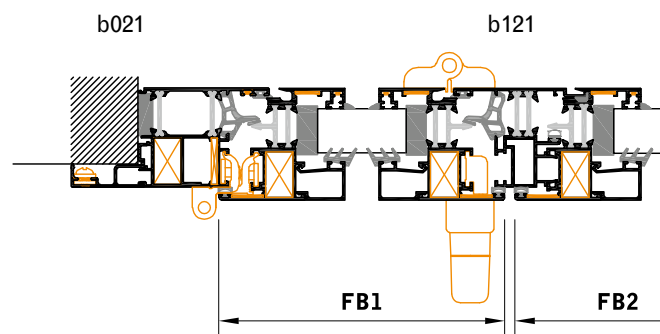
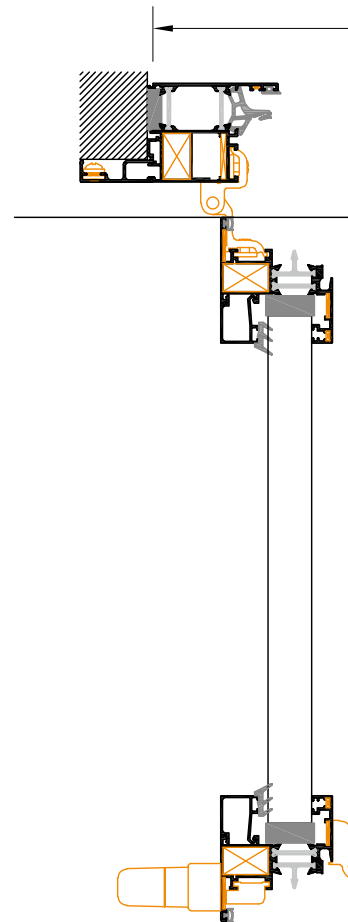

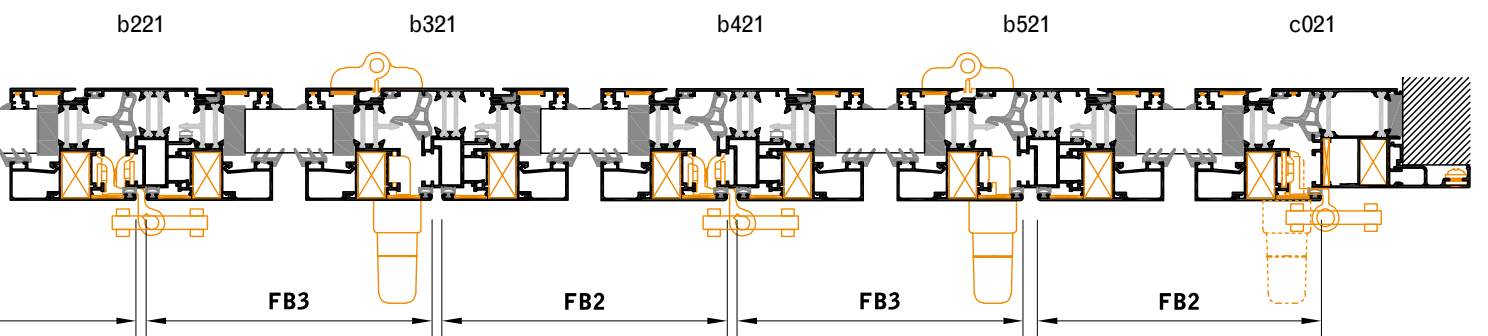
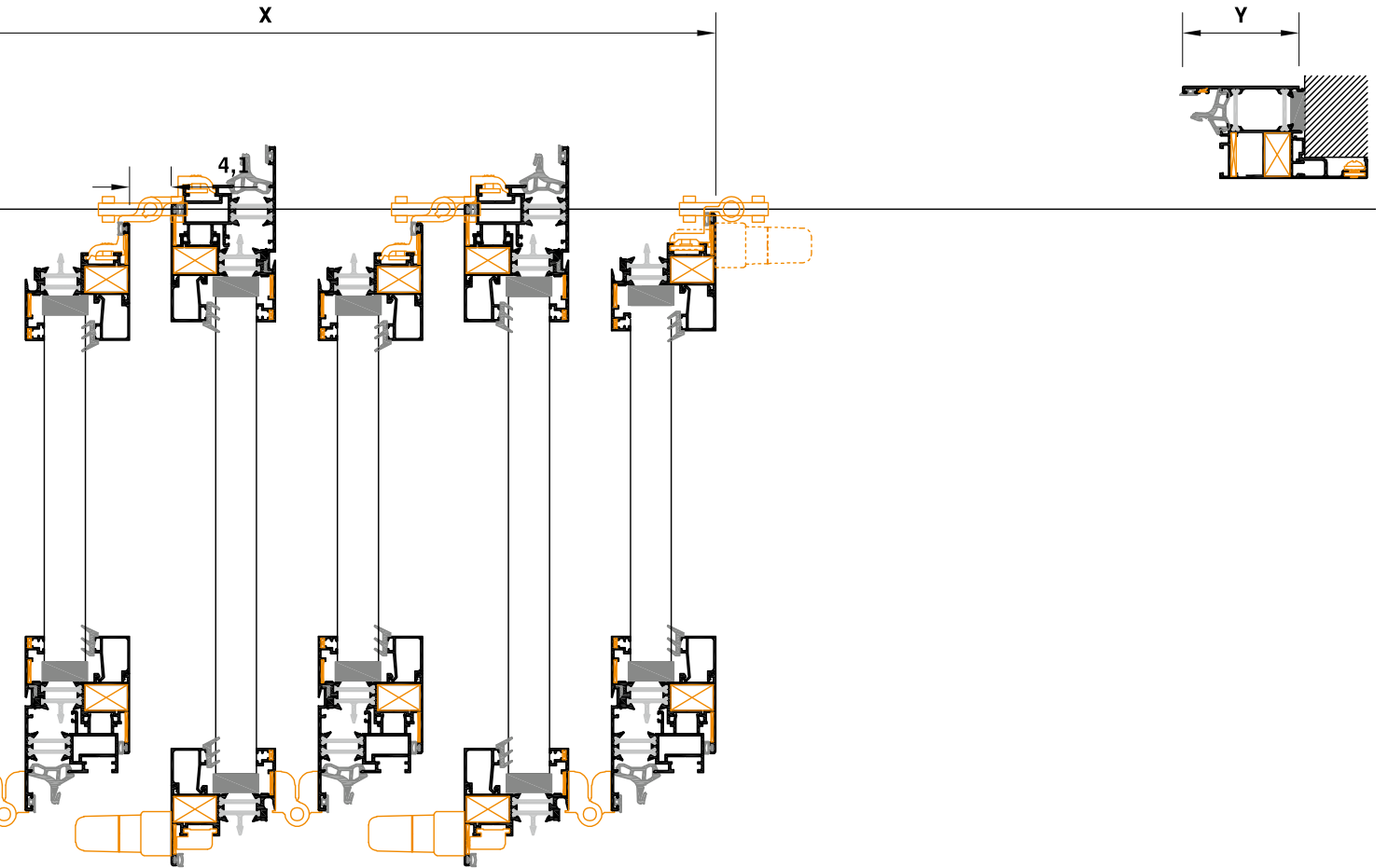
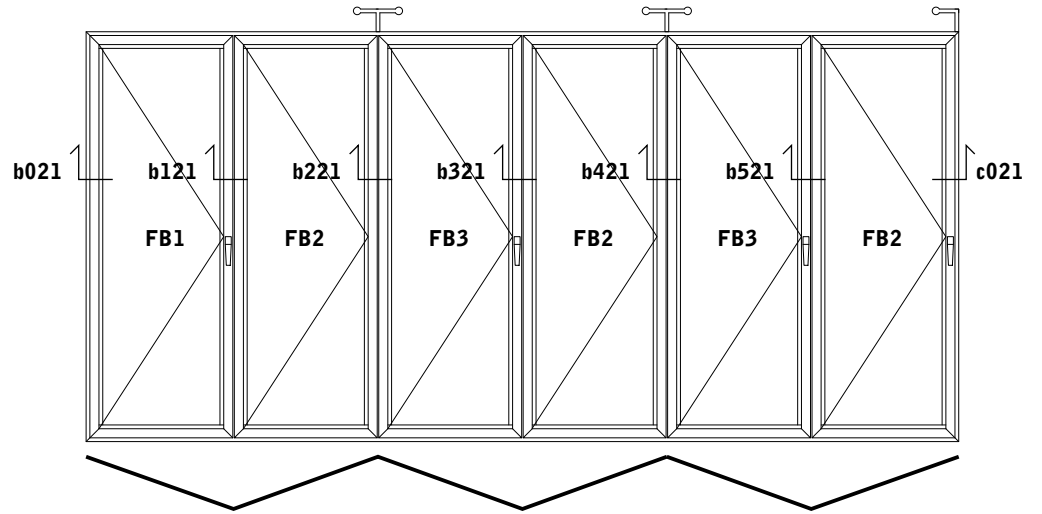

PLE
38



PLEGABLE APERTURA INTERIOR P600D1 (5 + 1)

MEDIDAS DE CORTE HOJAS Y MEDIDAS DE CRISTALES

PF43 ALFIL 45 HOJAS SISTEMA

	PF43-1190	PF43-1360/1990	PF43-1960/1990
--	-----------	----------------	----------------

MEDIDAS DE CORTE

FB1	(L/6)+7 mm	(L/6)+7 mm	(L/6)+7 mm
FB2	(L/6)-67,3 mm	(L/6)-67,3 mm	(L/6)-67,3 mm
FB3	(L/6)+9,9 mm	(L/6)+9,9 mm	(L/6)+9,9 mm

MEDIDAS DE CRISTALES

FB1	(L/6)-105,4 mm	(L/6)-155,4 mm	(L/6)-181 mm
FB2	(L/6)-179,7 mm	(L/6)-229,7 mm	(L/6)-255,3 mm
FB3	(L/6)-102,5 mm	(L/6)-152,5 mm	(L/6)-154,5 mm

PT45 / PT54 / PT80 HOJAS SISTEMA

	PTXX-1170 / 1190	PTXX-1360 / 1390	PTXX-1990
--	------------------	------------------	-----------

MEDIDAS DE CORTE

FB1	(L/6)+5 mm	(L/6)+5 mm	(L/6)+5 mm
FB2	(L/6)-69,3 mm	(L/6)-69,3 mm	(L/6)-69,3 mm
FB3	(L/6)+7,9 mm	(L/6)+7,9 mm	(L/6)+7,9 mm

MEDIDAS DE CRISTALES

FB1	(L/6)-107 mm	(L/6)-157,4 mm	(L/6)-181 mm
FB2	(L/6)-181,3 mm	(L/6)-231,7 mm	(L/6)-255,3 mm
FB3	(L/6)-104,1 mm	(L/6)-128,7 mm	(L/6)-154,5 mm

GROSOR HOJAS PLEGADAS

	PF43	PT45	PT54	PT80
X	394,3 mm	400,5 mm	446,5 mm	575,5 mm
Y	85,9 mm	92,1 mm	101,3 mm	127,1 mm

PESOS MÁXIMOS RECOMENDADOS POR HOJA

Tipología plegable (*)	ANCHURA / DIMENSIÓN HOJA			
	800 mm	700 mm	600 mm	500 mm
P600D1 (5 + 1) kg/hoja	25	35	45	50

(*) Para alturas mayores de 1800 mm recomendable utilizar hojas de puerta

LEYENDA: Manilla Pasador hoja pasiva Carros superiores

(1) Para hojas apertura exterior utilizar WOOR-1005 + CPAF-0651 + CPA0-9232

(2) Para hojas de puerta utilizaremos WOOR-9827H

ACCESORIOS SISTEMA

	REF	UD	H<1700 MM	H>1700 MM
MANILLAS (1)	CRAS-0760	3		
	CRAS-1760D / E	3		
	CRAS-9232	3		
PASADORES	CPAF-1508	1		
BISAGRAS	WOOR-9826		4	6
	WOOR-9826T		0	2
	WOOR-9827 (2)		4	6
JUEGO CARROS	WOOR-1352	2		
	WOOR-1352T	0		
	WOOR-1352H	0		

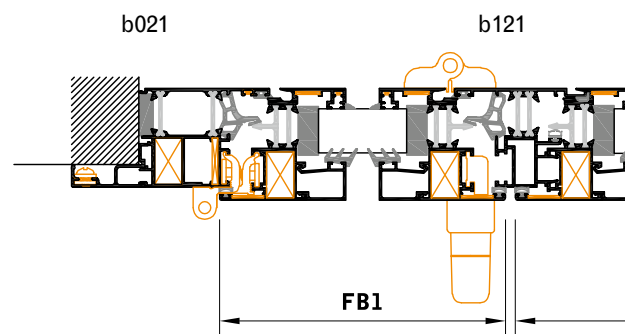
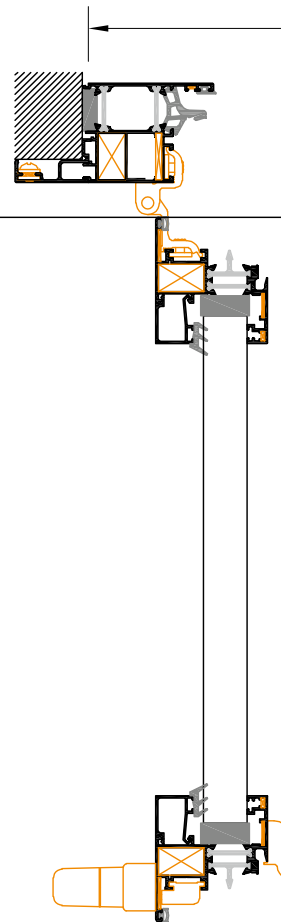

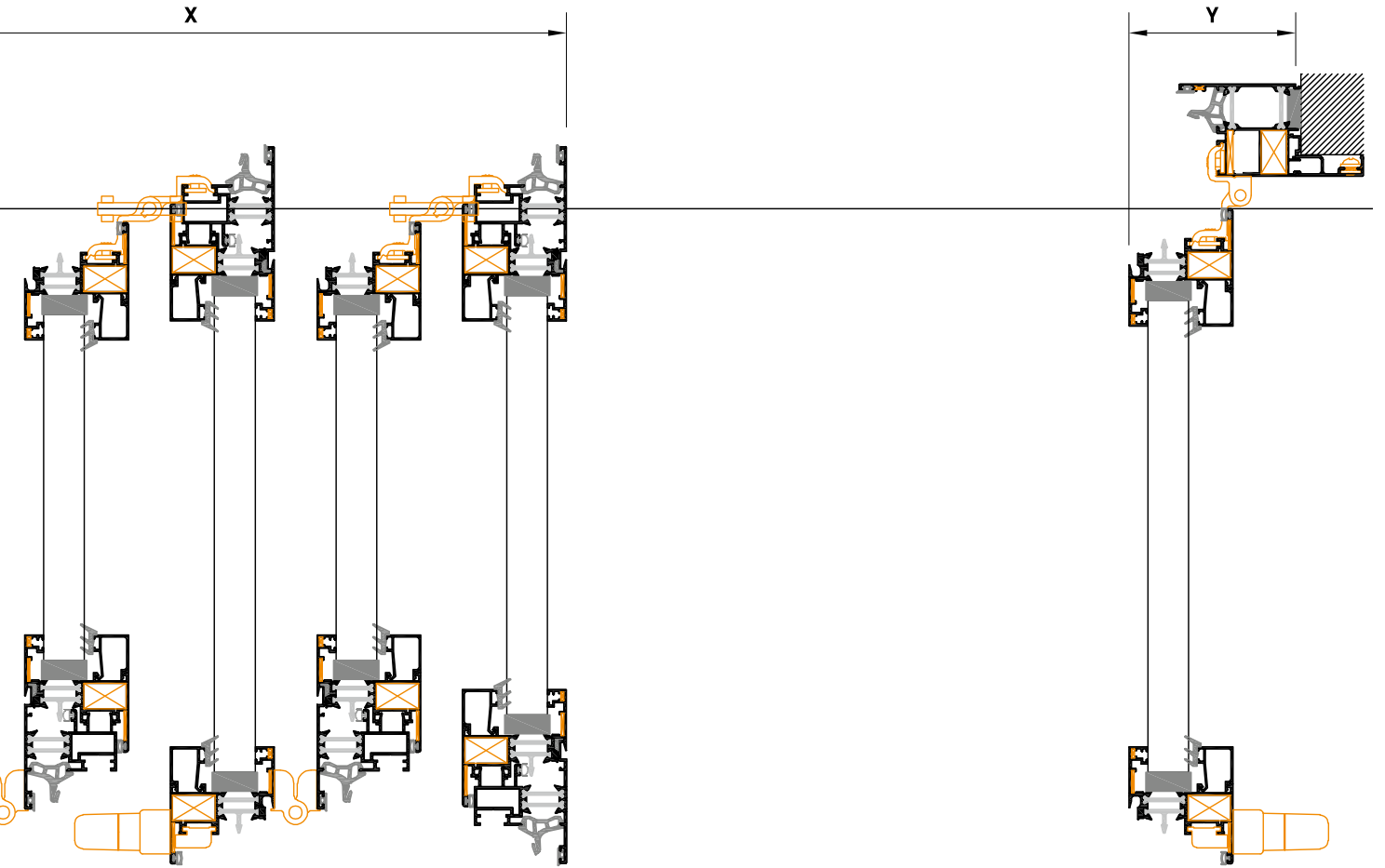
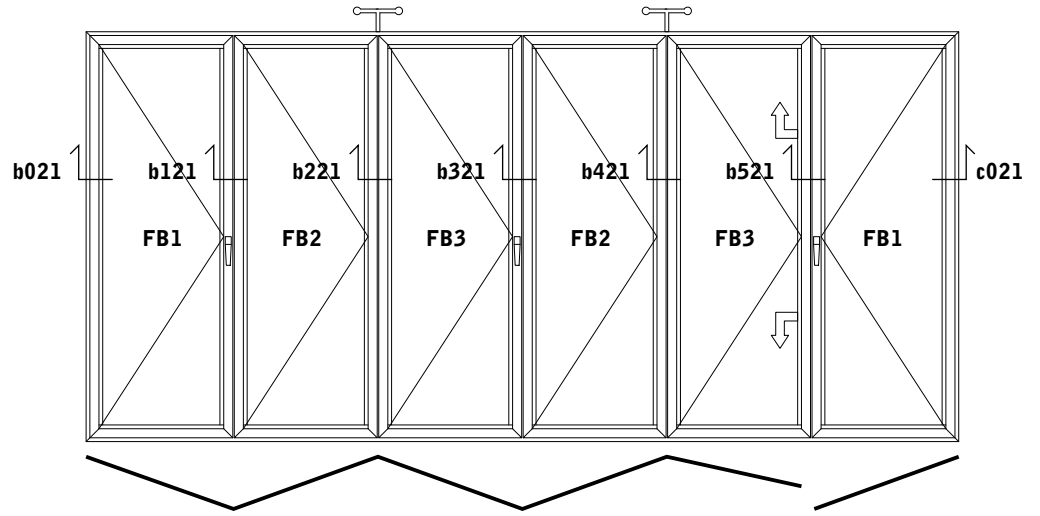

PLE
40

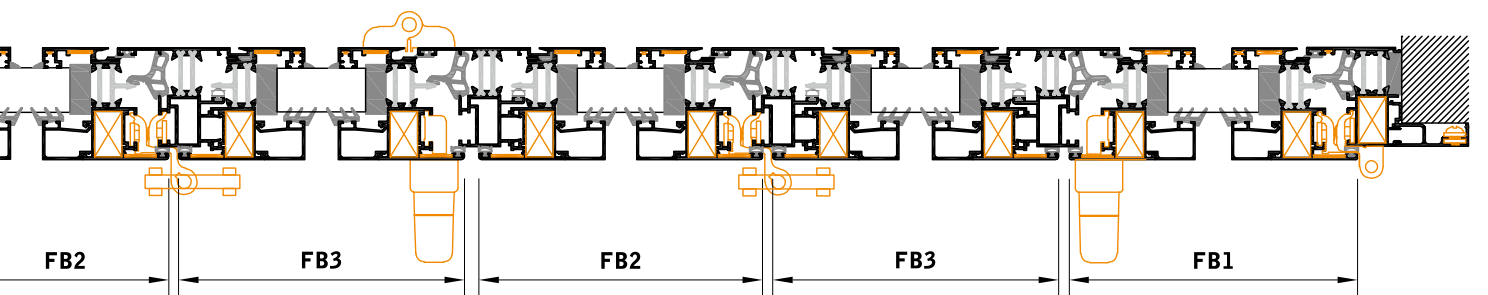



PLEGABLE APERTURA INTERIOR P600D3 (3 + 3)

MEDIDAS DE CORTE HOJAS Y MEDIDAS DE CRISTALES
PF43 ALFIL 45 HOJAS SISTEMA

	PF43-1190	PF43-1360/1990	PF43-1960/1990
--	-----------	----------------	----------------

MEDIDAS DE CORTE

FB1	(L/6)+7 mm	(L/6)+7 mm	(L/6)+7 mm
FB2	(L/6)-67,3 mm	(L/6)-67,3 mm	(L/6)-67,3 mm
FB3	(L/6)+9,9 mm	(L/6)+9,9 mm	(L/6)+9,9 mm

MEDIDAS DE CRISTALES

FB1	(L/6)-105,4 mm	(L/6)-155,4 mm	(L/6)-181 mm
FB2	(L/6)-179,7 mm	(L/6)-229,7 mm	(L/6)-255,3 mm
FB3	(L/6)-102,5 mm	(L/6)-152,5 mm	(L/6)-154,5 mm

PT45 / PT54 / PT80 HOJAS SISTEMA

	PTXX-1170 / 1190	PTXX-1360 / 1390	PTXX-1990
--	------------------	------------------	-----------

MEDIDAS DE CORTE

FB1	(L/6)+5 mm	(L/6)+5 mm	(L/6)+5 mm
FB2	(L/6)-69,3 mm	(L/6)-69,3 mm	(L/6)-69,3 mm
FB3	(L/6)+7,9 mm	(L/6)+7,9 mm	(L/6)+7,9 mm

MEDIDAS DE CRISTALES

FB1	(L/6)-107 mm	(L/6)-157,4 mm	(L/6)-181 mm
FB2	(L/6)-181,3 mm	(L/6)-231,7 mm	(L/6)-255,3 mm
FB3	(L/6)-104,1 mm	(L/6)-128,7 mm	(L/6)-154,5 mm

GROSOR HOJAS PLEGADAS

	PF43	PT45	PT54	PT80
X	240,1 mm	246,3 mm	273,9 mm	351,3 mm
Y	240,1 mm	246,3 mm	273,9 mm	351,3 mm

PESOS MÁXIMOS RECOMENDADOS POR HOJA

Tipología plegable (*)	ANCHURA / DIMENSIÓN HOJA			
	800 mm	700 mm	600 mm	500 mm
P600D3 (3 + 3) kg/hoja	35	45	50	55

(*) Para alturas mayores de 1800 mm recomendable utilizar hojas de puerta

LEYENDA: Manilla Pasador hoja pasiva Carros superiores

(1) Para hojas apertura exterior utilizar WOOR-1005 + CPAF-0651 + CPA0-9232

(2) Para hojas de puerta utilizaremos WOOR-9827H

ACCESORIOS SISTEMA

	REF	UD	H<1700 MM	H>1700 MM
MANILLAS (1)	CRAS-0760	3		
	CRAS-1760D / E	3		
	CRAS-9232	3		
PASADORES	CPAF-1508	1		
BISAGRAS	WOOR-9826		4	6
	WOOR-9826T		0	2
	WOOR-9827 (2)		4	6
JUEGO CARROS	WOOR-1352	2		
	WOOR-1352T	0		
	WOOR-1352H	0		

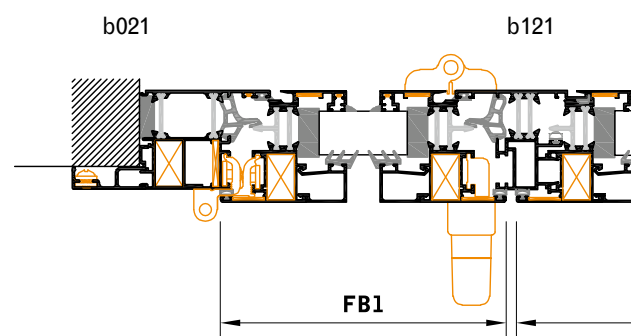
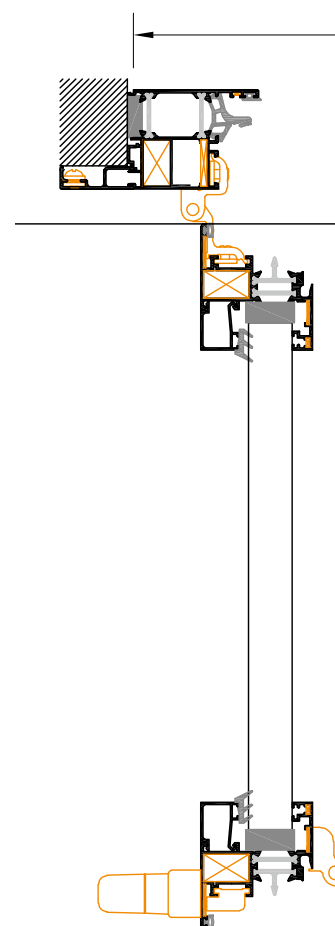

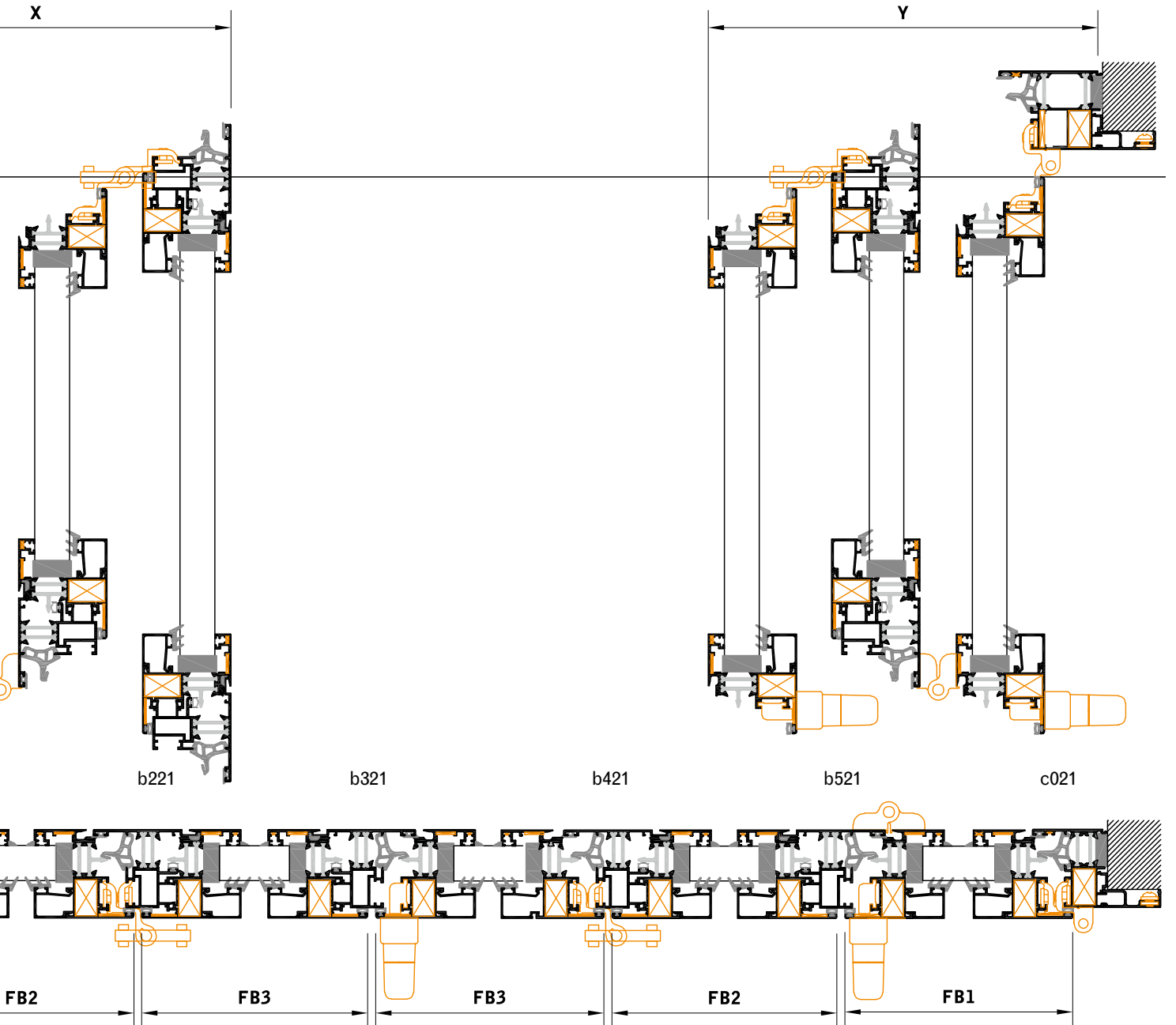
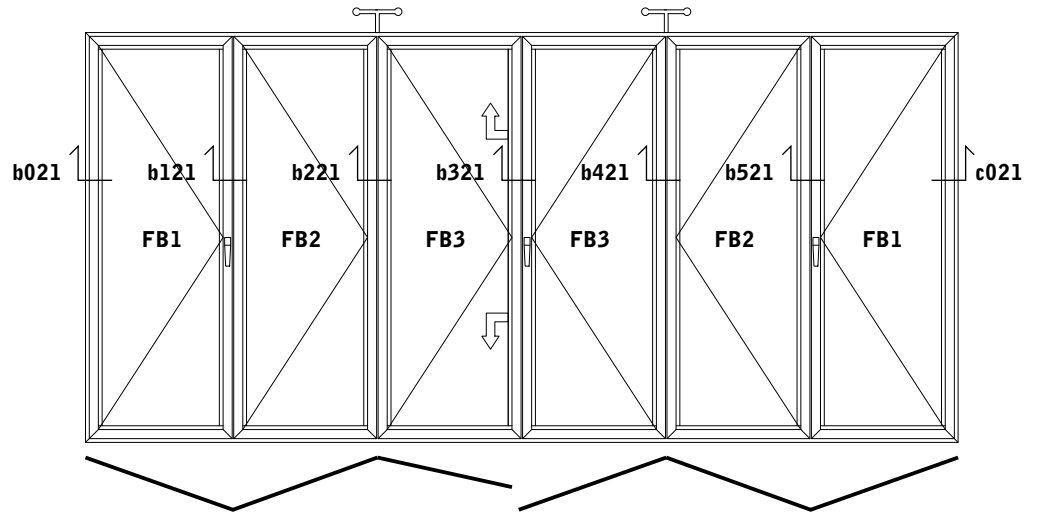

PLE
42



PLEGABLE APERTURA INTERIOR P700E7 (7 + 0)

MEDIDAS DE CORTE HOJAS Y MEDIDAS DE CRISTALES
PF43 ALFIL 45 HOJAS SISTEMA

	PF43-1190	PF43-1360/1990	PF43-1960/1990
MEDIDAS DE CORTE			
FB1	(L/7)+15,9 mm	(L/7)+15,9 mm	(L/7)+15,9 mm
FB2	(L/7)-58,4 mm	(L/7)-58,4 mm	(L/7)-58,4 mm
FB3	(L/7)+18,8 mm	(L/7)+18,8 mm	(L/7)+18,8 mm
MEDIDAS DE CRISTALES			
FB1	(L/7)-96,5 mm	(L/7)-146,5 mm	(L/7)-171,8 mm
FB2	(L/7)-170,8 mm	(L/7)-220,8 mm	(L/7)-246,1 mm
FB3	(L/7)-93,6 mm	(L/7)-143,6 mm	(L/7)-145,3 mm

PT45 / PT54 / PT80 HOJAS SISTEMA

	PTXX-1170 / 1190	PTXX-1360 / 1390	PTXX-1990
MEDIDAS DE CORTE			
FB1	(L/7)+14,2 mm	(L/7)+14,2 mm	(L/7)+14,2 mm
FB2	(L/7)-60,1 mm	(L/7)-60,1 mm	(L/7)-60,1 mm
FB3	(L/7)+17,1 mm	(L/7)+17,1 mm	(L/7)+17,1 mm
MEDIDAS DE CRISTALES			
FB1	(L/7)-97,8 mm	(L/7)-148,2 mm	(L/7)-171,8 mm
FB2	(L/7)-172,1 mm	(L/7)-222,5 mm	(L/7)-246,1 mm
FB3	(L/7)-94,9 mm	(L/7)-119,5 mm	(L/7)-145,3 mm

GROSOR HOJAS PLEGADAS

	PF43	PT45	PT54	PT80
X	548,5 mm	554,7 mm	619,1 mm	799,7 mm
Y	65,5 mm	71,7 mm	71,7 mm	75,5 mm

PESOS MÁXIMOS RECOMENDADOS POR HOJA

Tipología plegable (*)	ANCHURA / DIMENSIÓN HOJA			
	800 mm	700 mm	600 mm	500 mm
P700E7 (7 + 0) kg/hoja	20	30	40	45

(*) Para alturas mayores de 1800 mm recomendable utilizar hojas de puerta

LEYENDA: Manilla Pasador hoja pasiva Carros superiores
 (1) Para hojas apertura exterior utilizar WOOR-1005 + CPAF-0651 + CPA0-9232
 (2) Para hojas de puerta utilizaremos WOOR-9827H

ACCESORIOS SISTEMA

	REF	UD	H<1700 MM	H>1700 MM
MANILLAS (1)	CRAS-0760	4		
	CRAS-1760D / E	4		
	CRAS-9232	4		
PASADORES	CPAF-1508	0		
	WOOR-9826		2	3
BISAGRAS	WOOR-9826T		0	3
	WOOR-9827 (2)		6	9
	WOOR-1352		3	
JUEGO CARROS	WOOR-1352T		0	
	WOOR-1352H		0	

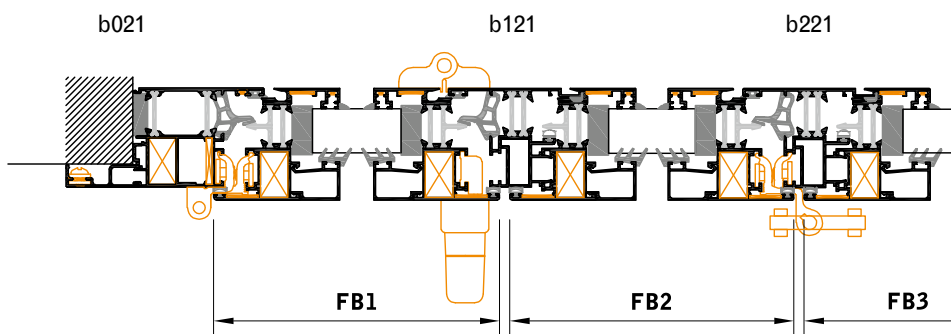
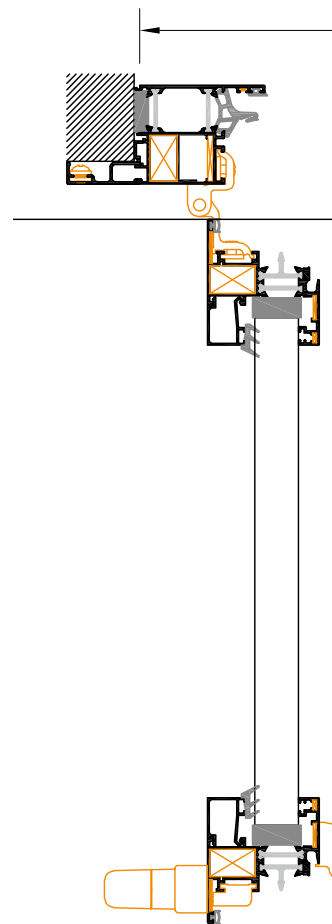

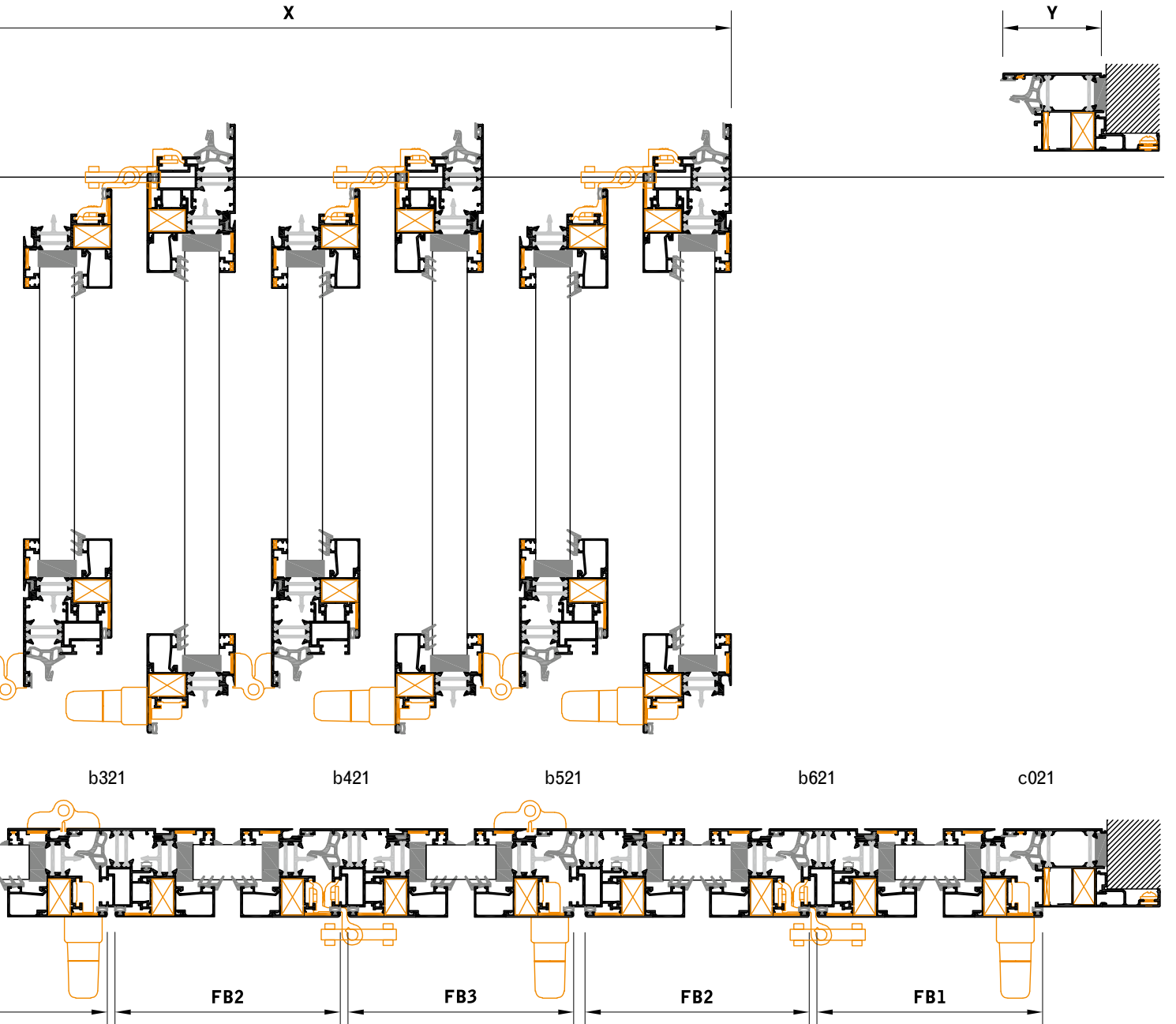
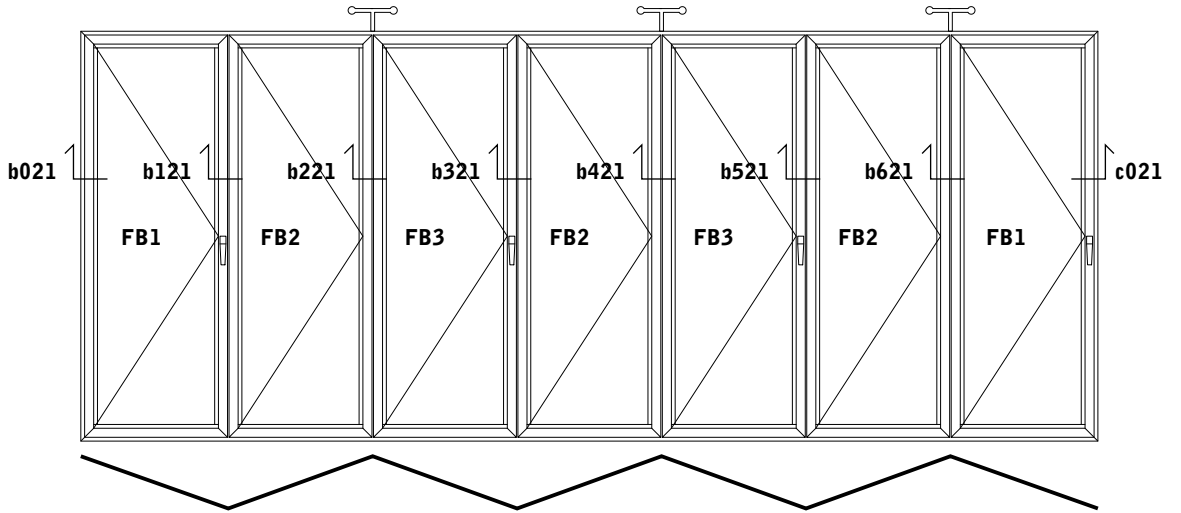

PLE
44

PLEGABLE APERTURA INTERIOR P700D1 (6 + 1)

MEDIDAS DE CORTE HOJAS Y MEDIDAS DE CRISTALES

PF43 ALFIL 45 HOJAS SISTEMA

	PF43-1190	PF43-1360/1990	PF43-1960/1990
MEDIDAS DE CORTE			
FB1	(L/7)+14,1 mm	(L/7)+14,1 mm	(L/7)+14,1 mm
FB2	(L/7)-60,2 mm	(L/7)-60,2 mm	(L/7)-60,2 mm
FB3	(L/7)+17 mm	(L/7)+17 mm	(L/7)+17 mm
FB4	(L/7)-49,2 mm	(L/7)-49,2 mm	(L/7)-49,2 mm
MEDIDAS DE CRISTALES			
FB1	(L/7)-98,3 mm	(L/7)-148,3 mm	(L/7)-173,6 mm
FB2	(L/7)-172,6 mm	(L/7)-222,6 mm	(L/7)-247,9 mm
FB3	(L/7)-95,4 mm	(L/7)-145,4 mm	(L/7)-147,1 mm
FB4	(L/7)-161,6 mm	(L/7)-211,6 mm	(L/7)-213,3 mm

PT45 / PT54 / PT80 HOJAS SISTEMA

	PTXX-1170 / 1190	PTXX-1360 / 1390	PTXX-1990
MEDIDAS DE CORTE			
FB1	(L/7)+12,4 mm	(L/7)+12,4 mm	(L/7)+12,4 mm
FB2	(L/7)-61,9 mm	(L/7)-61,9 mm	(L/7)-61,9 mm
FB3	(L/7)+15,3 mm	(L/7)+15,3 mm	(L/7)+15,3 mm
FB4	(L/7)-50,9 mm	(L/7)-50,9 mm	(L/7)-50,9 mm
MEDIDAS DE CRISTALES			
FB1	(L/7)-99,6 mm	(L/7)-150 mm	(L/7)-173,6 mm
FB2	(L/7)-173,9 mm	(L/7)-224,3 mm	(L/7)-247,9 mm
FB3	(L/7)-96,7 mm	(L/7)-121,3 mm	(L/7)-147,1 mm
FB4	(L/7)-162,9 mm	(L/7)-187,5 mm	(L/7)-213,3 mm



GROSOR HOJAS PLEGADAS

	PF43	PT45	PT54	PT80
X	471,4 mm	477,6 mm	532,8 mm	687,6 mm
Y	85,9 mm	92,1 mm	101,3 mm	127,1 mm

PESOS MÁXIMOS RECOMENDADOS POR HOJA

Tipología plegable (*)	ANCHURA / DIMENSIÓN HOJA			
	800 mm	700 mm	600 mm	500 mm
P700D1 (6 + 1) kg/hoja	30	50	55	60

(*) Para alturas mayores de 1800 mm recomendable utilizar hojas de puerta

LEYENDA:  Manilla  Pasador hoja pasiva  Carros superiores

(1) Para hojas apertura exterior utilizar WOOR-1005 + CPAF-0651 + CPA0-9232
(2) Para hojas de puerta utilizaremos WOOR-9827H

ACCESORIOS SISTEMA

	REF	UD	H<1700 MM	H>1700 MM
MANILLAS (1)	CRAS-0760	4		
	CRAS-1760D / E	4		
	CRAS-9232	4		
PASADORES	CPAF-1508	0		
BISAGRAS	WOOR-9826		4	6
	WOOR-9826T		0	2
	WOOR-9827 (2)		6	9
JUEGO CARROS	WOOR-1352	2		
	WOOR-1352T	1		
	WOOR-1352H	0		

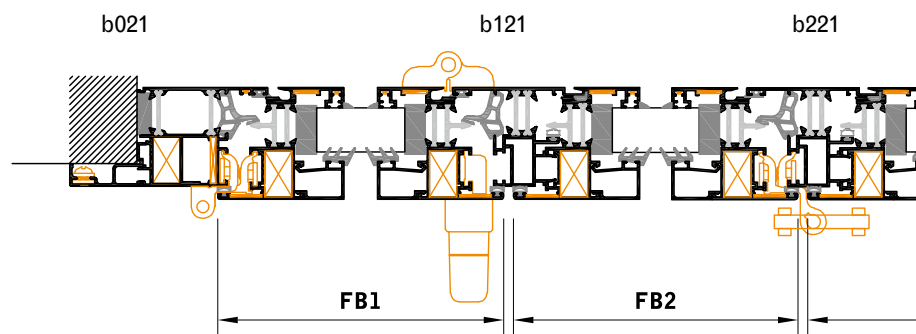
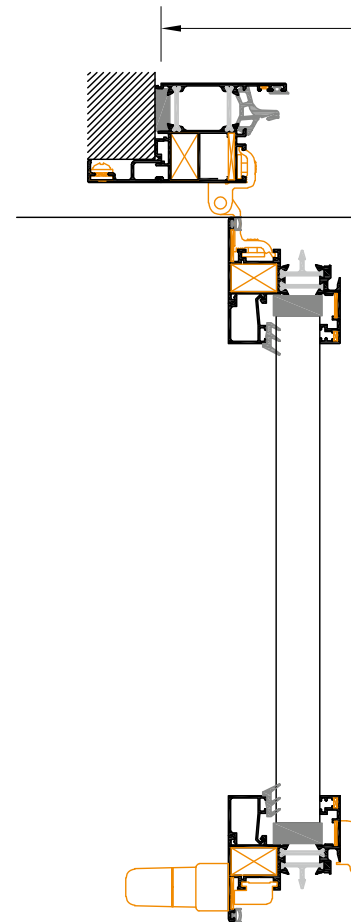

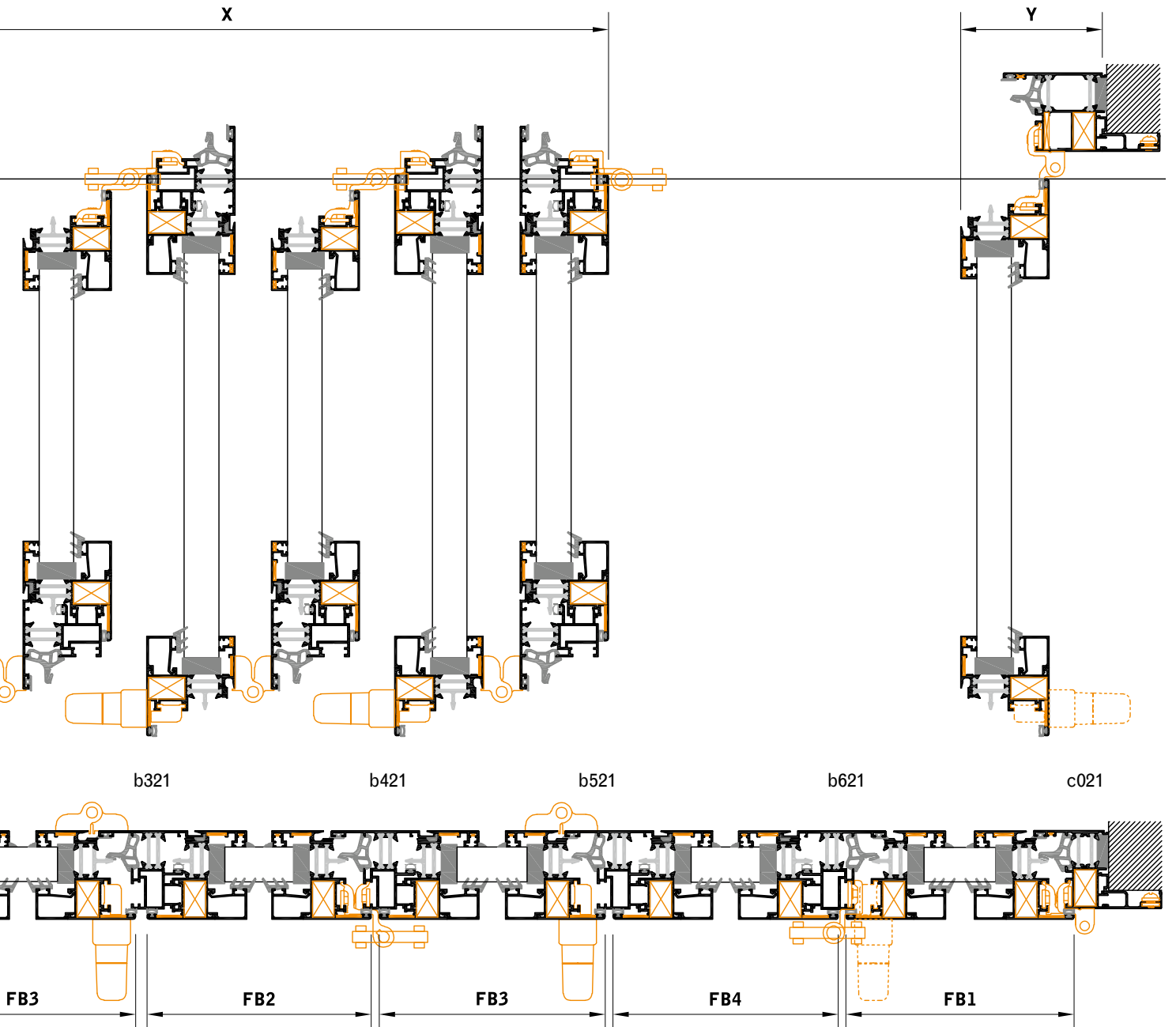
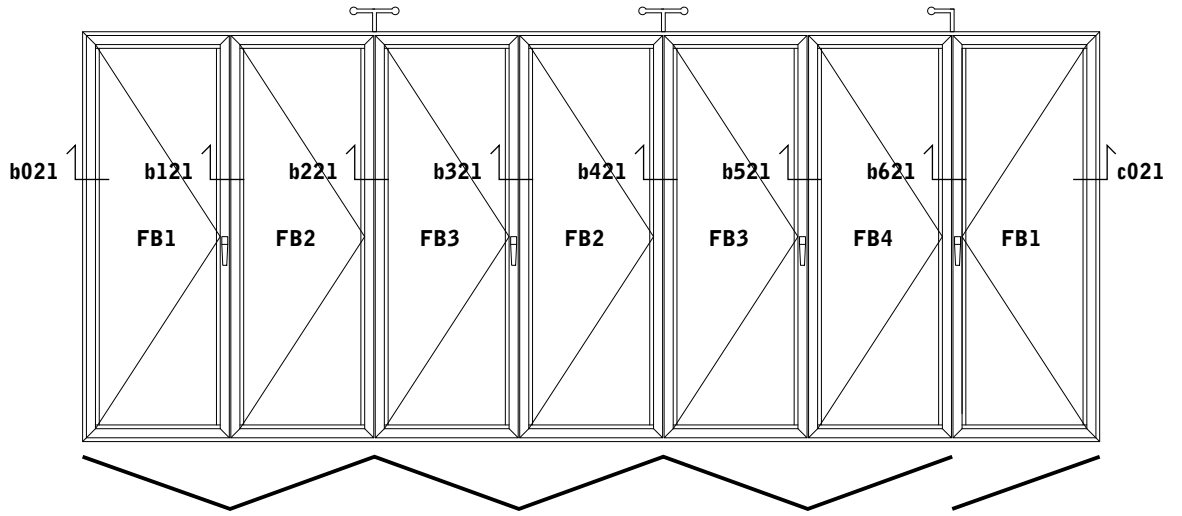

PLE
46



PLEGABLE APERTURA INTERIOR P700D2 (5 + 2)

MEDIDAS DE CORTE HOJAS Y MEDIDAS DE CRISTALES

PF43 ALFIL 45 HOJAS SISTEMA

	PF43-1190	PF43-1360/1990	PF43-1960/1990
MEDIDAS DE CORTE			
FB1	(L/7)+14,1 mm	(L/7)+14,1 mm	(L/7)+14,1 mm
FB2	(L/7)-60,2 mm	(L/7)-60,2 mm	(L/7)-60,2 mm
FB3	(L/7)+17 mm	(L/7)+17 mm	(L/7)+17 mm
FB4	(L/7)-49,2 mm	(L/7)-49,2 mm	(L/7)-49,2 mm
MEDIDAS DE CRISTALES			
FB1	(L/7)-98,3 mm	(L/7)-148,3 mm	(L/7)-173,6 mm
FB2	(L/7)-172,6 mm	(L/7)-222,6 mm	(L/7)-247,9 mm
FB3	(L/7)-95,4 mm	(L/7)-145,4 mm	(L/7)-147,1 mm
FB4	(L/7)-161,6 mm	(L/7)-211,6 mm	(L/7)-213,3 mm

PT45 / PT54 / PT80 HOJAS SISTEMA

	PTXX-1170 / 1190	PTXX-1360 / 1390	PTXX-1990
MEDIDAS DE CORTE			
FB1	(L/7)+12,4 mm	(L/7)+12,4 mm	(L/7)+12,4 mm
FB2	(L/7)-61,9 mm	(L/7)-61,9 mm	(L/7)-61,9 mm
FB3	(L/7)+15,3 mm	(L/7)+15,3 mm	(L/7)+15,3 mm
FB4	(L/7)-50,9 mm	(L/7)-50,9 mm	(L/7)-50,9 mm
MEDIDAS DE CRISTALES			
FB1	(L/7)-99,6 mm	(L/7)-150 mm	(L/7)-173,6 mm
FB2	(L/7)-173,9 mm	(L/7)-224,3 mm	(L/7)-247,9 mm
FB3	(L/7)-96,7 mm	(L/7)-121,3 mm	(L/7)-147,1 mm
FB4	(L/7)-162,9 mm	(L/7)-187,5 mm	(L/7)-213,3 mm

GROSOR HOJAS PLEGADAS

	PF43	PT45	PT54	PT80
X	394,3 mm	400,5 mm	446,5 mm	575,5 mm
Y	163 mm	169,2 mm	187,6 mm	239,2 mm

PESOS MÁXIMOS RECOMENDADOS POR HOJA

Tipología plegable (*)	ANCHURA / DIMENSIÓN HOJA			
	800 mm	700 mm	600 mm	500 mm
P700D2 (5 + 2) kg/hoja	25	35	45	50

(*) Para alturas mayores de 1800 mm recomendable utilizar hojas de puerta

LEYENDA: Manilla Pasador hoja pasiva Carros superiores

(1) Para hojas apertura exterior utilizar WOOR-1005 + CPAF-0651 + CPA0-9232
(2) Para hojas de puerta utilizaremos WOOR-9827H

ACCESORIOS SISTEMA

	REF	UD	H<1700 MM	H>1700 MM
MANILLAS (1)	CRAS-0760	4		
	CRAS-1760D / E	4		
	CRAS-9232	4		
PASADORES	CPAF-1508	0		
BISAGRAS	WOOR-9826		4	6
	WOOR-9826T		0	2
	WOOR-9827 (2)		6	9
JUEGO CARROS	WOOR-1352	2		
	WOOR-1352T	1		
	WOOR-1352H	0		

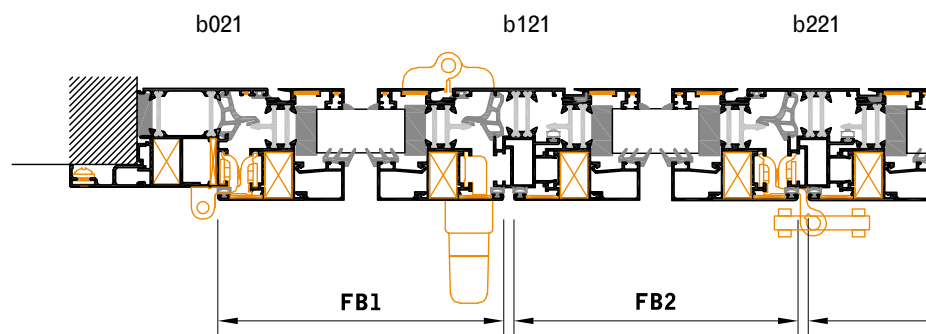
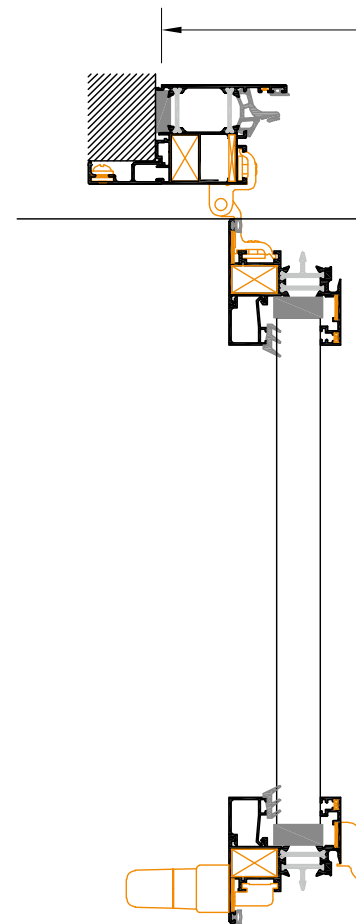

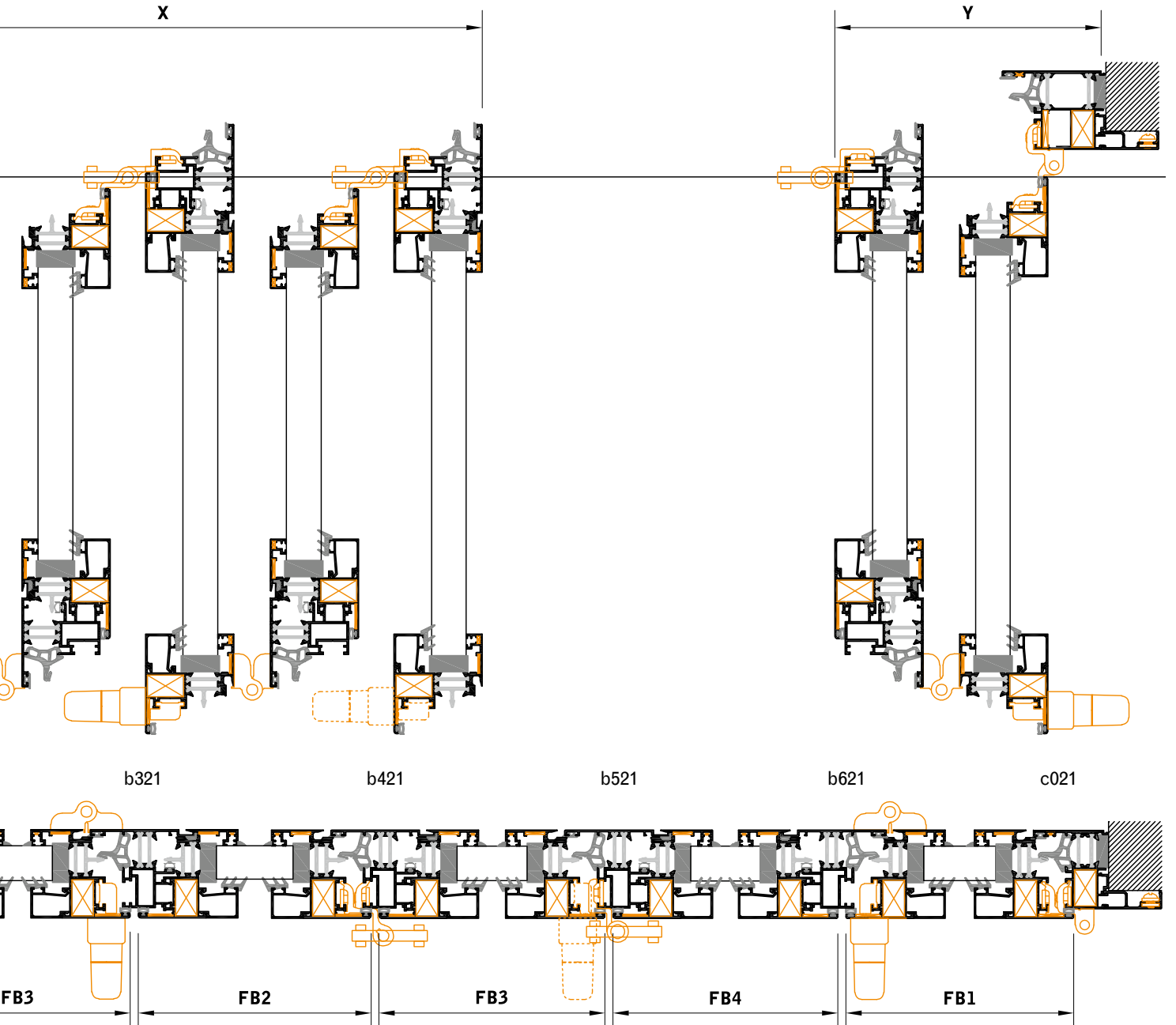
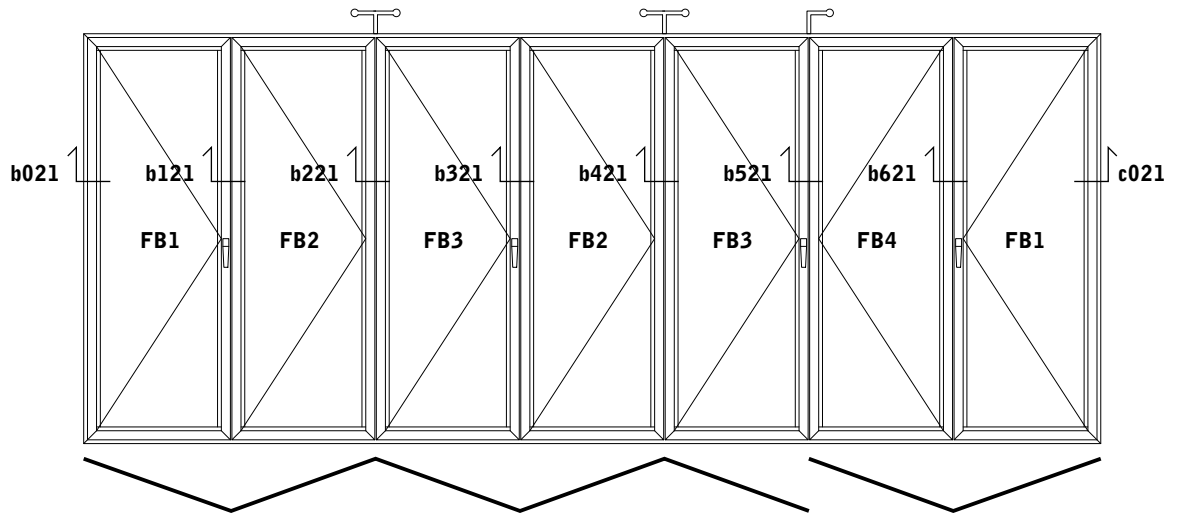

PLE
48

PLEGABLE APERTURA INTERIOR P700D3 (4 + 3)

MEDIDAS DE CORTE HOJAS Y MEDIDAS DE CRISTALES

PF43 ALFIL 45 HOJAS SISTEMA

	PF43-1190	PF43-1360/1990	PF43-1960/1990
--	-----------	----------------	----------------

MEDIDAS DE CORTE

FB1	(L/7)+14,1 mm	(L/7)+14,1 mm	(L/7)+14,1 mm
FB2	(L/7)-60,2 mm	(L/7)-60,2 mm	(L/7)-60,2 mm
FB3	(L/7)+17 mm	(L/7)+17 mm	(L/7)+17 mm
FB4	(L/7)-49,2 mm	(L/7)-49,2 mm	(L/7)-49,2 mm

MEDIDAS DE CRISTALES

FB1	(L/7)-98,3 mm	(L/7)-148,3 mm	(L/7)-173,6 mm
FB2	(L/7)-172,6 mm	(L/7)-222,6 mm	(L/7)-247,9 mm
FB3	(L/7)-95,4 mm	(L/7)-145,4 mm	(L/7)-147,1 mm
FB4	(L/7)-161,6 mm	(L/7)-211,6 mm	(L/7)-213,3 mm

PT45 / PT54 / PT80 HOJAS SISTEMA

	PTXX-1170 / 1190	PTXX-1360 / 1390	PTXX-1990
--	------------------	------------------	-----------

MEDIDAS DE CORTE

FB1	(L/7)+12,4 mm	(L/7)+12,4 mm	(L/7)+12,4 mm
FB2	(L/7)-61,9 mm	(L/7)-61,9 mm	(L/7)-61,9 mm
FB3	(L/7)+15,3 mm	(L/7)+15,3 mm	(L/7)+15,3 mm
FB4	(L/7)-50,9 mm	(L/7)-50,9 mm	(L/7)-50,9 mm

MEDIDAS DE CRISTALES

FB1	(L/7)-99,6 mm	(L/7)-150 mm	(L/7)-173,6 mm
FB2	(L/7)-173,9 mm	(L/7)-224,3 mm	(L/7)-247,9 mm
FB3	(L/7)-96,7 mm	(L/7)-121,3 mm	(L/7)-147,1 mm
FB4	(L/7)-162,9 mm	(L/7)-187,5 mm	(L/7)-213,3 mm



GROSOR HOJAS PLEGADAS

	PF43	PT45	PT54	PT80
X	317,2 mm	323,4 mm	360,2 mm	463,4 mm
Y	240,1 mm	246,3 mm	273,9 mm	351,3 mm

PESOS MÁXIMOS RECOMENDADOS POR HOJA

Tipología plegable (*)	ANCHURA / DIMENSIÓN HOJA			
	800 mm	700 mm	600 mm	500 mm
P700D3 (4 + 3) kg/hoja	35	45	50	55

(*) Para alturas mayores de 1800 mm recomendable utilizar hojas de puerta

LEYENDA:  Manilla  Pasador hoja pasiva  Carros superiores

(1) Para hojas apertura exterior utilizar WOOR-1005 + CPAF-0651 + CPA0-9232
(2) Para hojas de puerta utilizaremos WOOR-9827H

ACCESORIOS SISTEMA

	REF	UD	H<1700 MM	H>1700 MM
MANILLAS (1)	CRAS-0760	4		
	CRAS-1760D / E	4		
	CRAS-9232	4		
PASADORES	CPAF-1508	0		
BISAGRAS	WOOR-9826		4	6
	WOOR-9826T		0	2
	WOOR-9827 (2)		6	9
JUEGO CARROS	WOOR-1352	2		
	WOOR-1352T	1		
	WOOR-1352H	0		

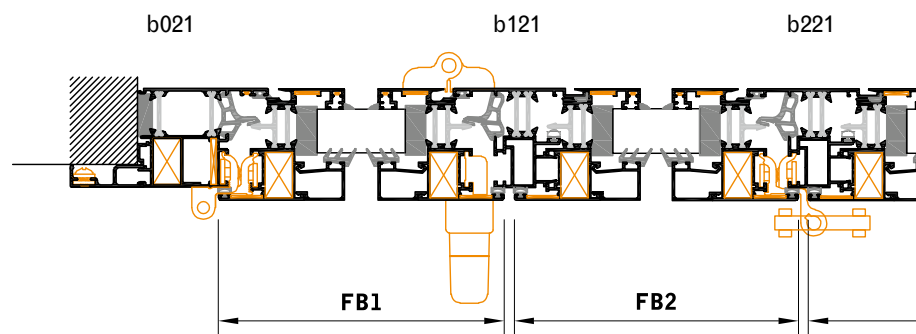
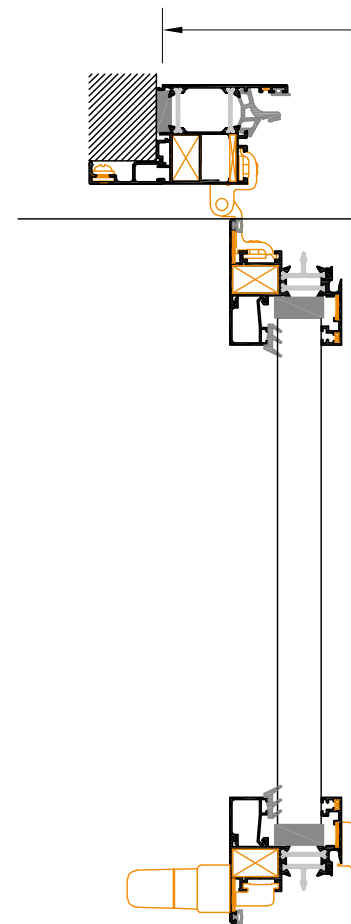

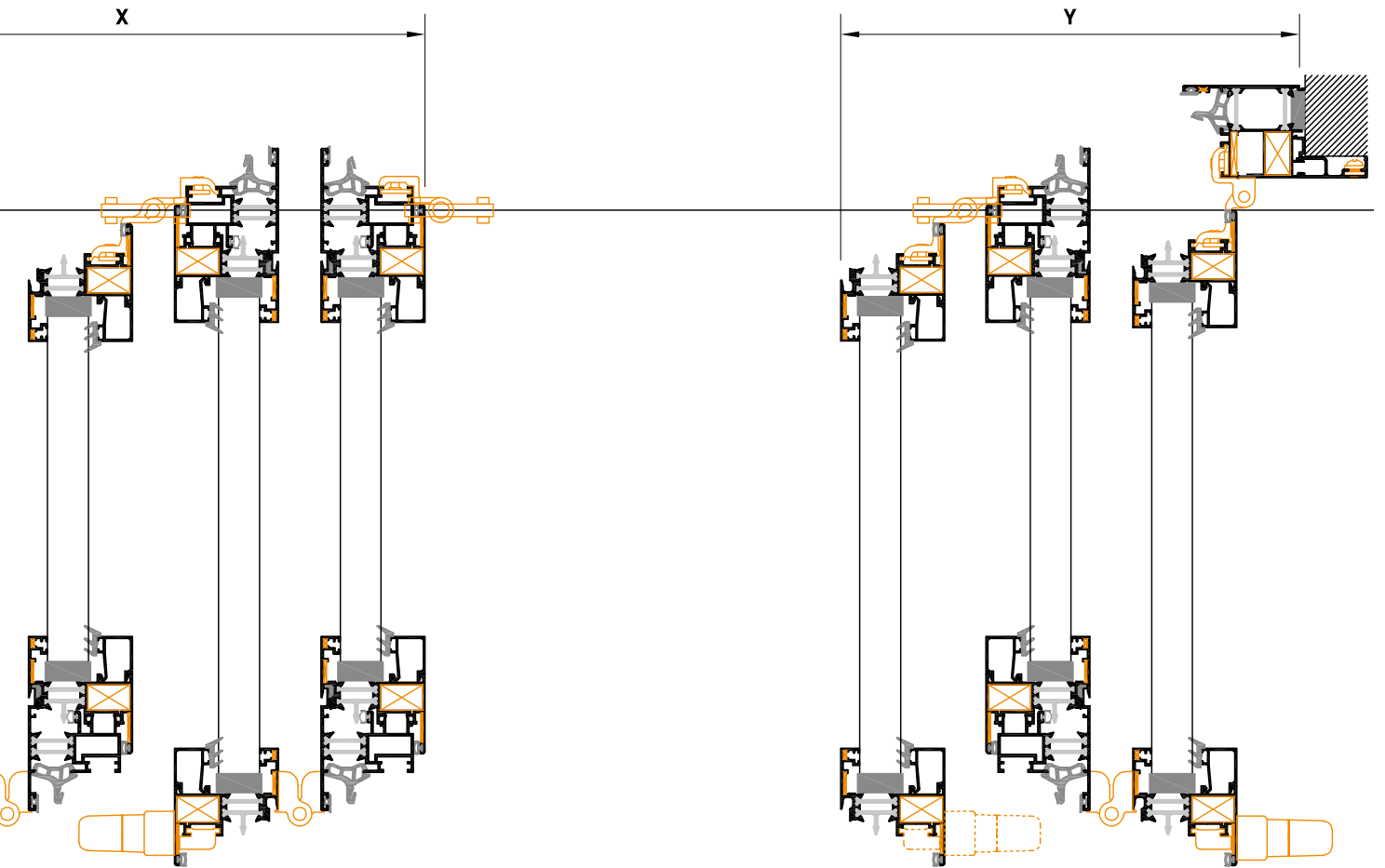
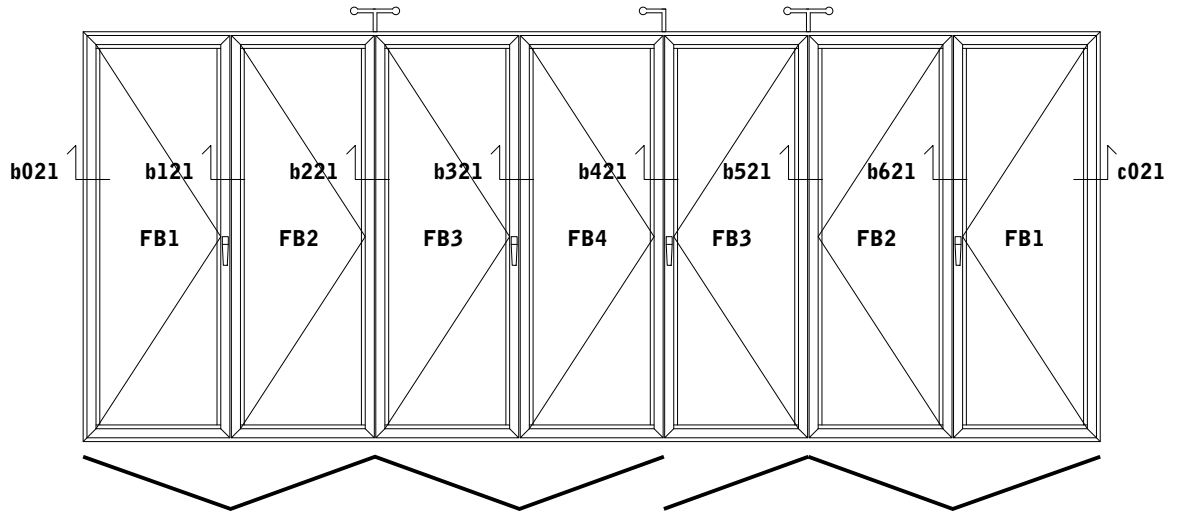

PLE
50

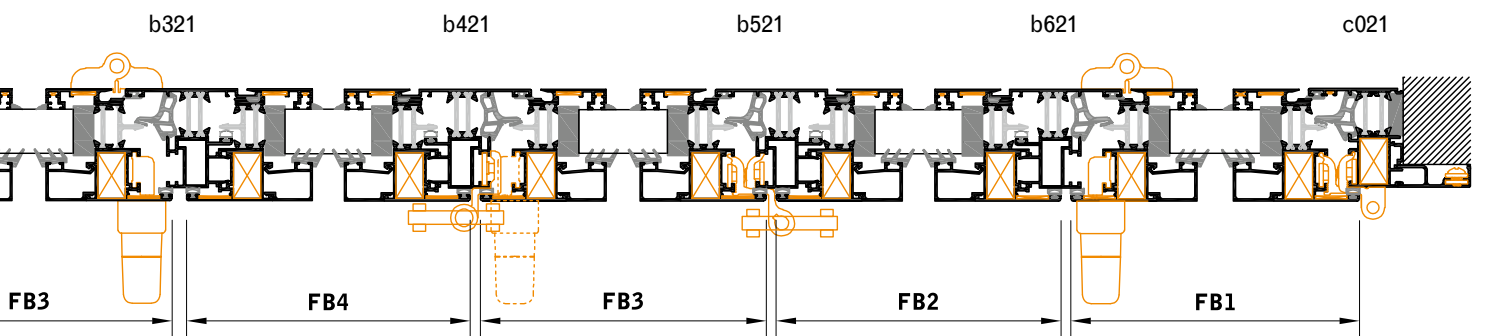



PLEGABLE APERTURA INTERIOR P900E9 (9 + 0)

MEDIDAS DE CORTE HOJAS Y MEDIDAS DE CRISTALES

PF43 ALFIL 45 HOJAS SISTEMA

	PF43-1190	PF43-1360/1990	PF43-1960/1990
--	-----------	----------------	----------------

MEDIDAS DE CORTE

FB1	(L/9)+19,1 mm	(L/9)+19,1 mm	(L/9)+19,1 mm
FB2	(L/9)-55,2 mm	(L/9)-55,2 mm	(L/9)-55,2 mm
FB3	(L/9)+22 mm	(L/9)+22 mm	(L/9)+22 mm

MEDIDAS DE CRISTALES

FB1	(L/9)-93,3 mm	(L/9)-143,3 mm	(L/9)-168,2 mm
FB2	(L/9)-167,6 mm	(L/9)-217,6 mm	(L/9)-242,5 mm
FB3	(L/9)-90,4 mm	(L/9)-140,4 mm	(L/9)-141,7 mm

PT45 / PT54 / PT80 HOJAS SISTEMA

	PTXX-1170 / 1190	PTXX-1360 / 1390	PTXX-1990
--	------------------	------------------	-----------

MEDIDAS DE CORTE

FB1	(L/9)+17,8 mm	(L/9)+17,8 mm	(L/9)+17,8 mm
FB2	(L/9)-56,5 mm	(L/9)-56,5 mm	(L/9)-56,5 mm
FB3	(L/9)+20,7 mm	(L/9)+20,7 mm	(L/9)+20,7 mm

MEDIDAS DE CRISTALES

FB1	(L/9)-94,2 mm	(L/9)-144,6 mm	(L/9)-168,2 mm
FB2	(L/9)-168,5 mm	(L/9)-218,9 mm	(L/9)-242,5 mm
FB3	(L/9)-91,3 mm	(L/9)-115,9 mm	(L/9)-141,7 mm

GROSOR HOJAS PLEGADAS

	PF43	PT45	PT54	PT80
X	702,7 mm	708,9 mm	791,7 mm	1023,9 mm
Y	65,5 mm	71,7 mm	71,7 mm	75,5 mm

PESOS MÁXIMOS RECOMENDADOS POR HOJA

Tipología plegable (*)	ANCHURA / DIMENSIÓN HOJA			
	800 mm	700 mm	600 mm	500 mm
P900E9 (9 + 0) kg/hoja	15	25	35	40

(*) Para alturas mayores de 1800 mm recomendable utilizar hojas de puerta

LEYENDA: Manilla Pasador hoja pasiva Carros superiores

(1) Para hojas apertura exterior utilizar WOOR-1005 + CPAF-0651 + CPA0-9232

(2) Para hojas de puerta utilizaremos WOOR-9827H

ACCESORIOS SISTEMA

	REF	UD	H<1700 MM	H>1700 MM
MANILLAS (1)	CRAS-0760	5		
	CRAS-1760D / E	5		
	CRAS-9232	5		
PASADORES	CPAF-1508	0		
	WOOR-9826		2	3
BISAGRAS	WOOR-9826T		0	4
	WOOR-9827 (2)		8	12
	WOOR-1352		4	
JUEGO CARROS	WOOR-1352T		0	
	WOOR-1352H		0	

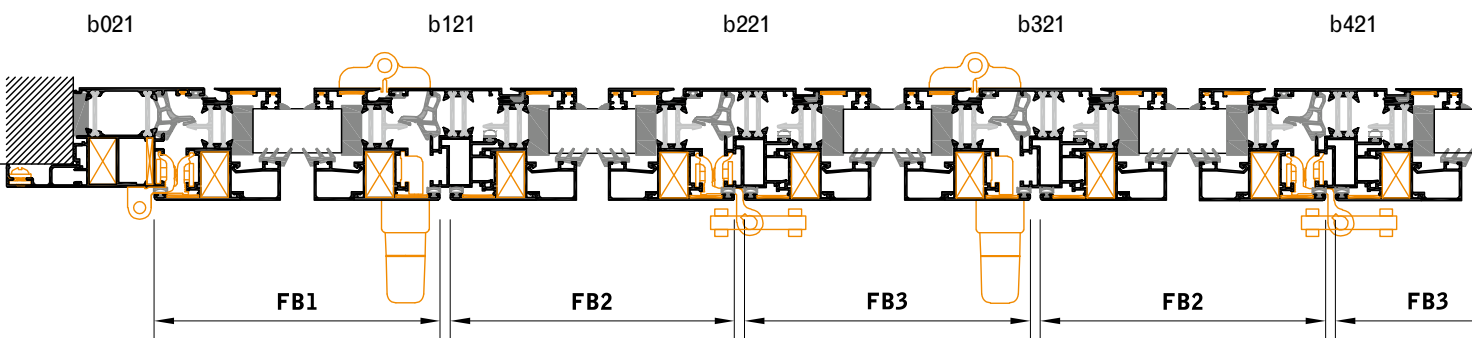
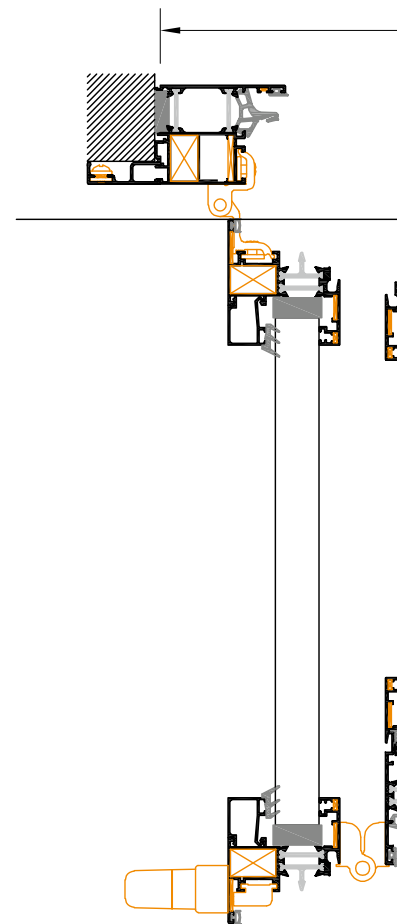

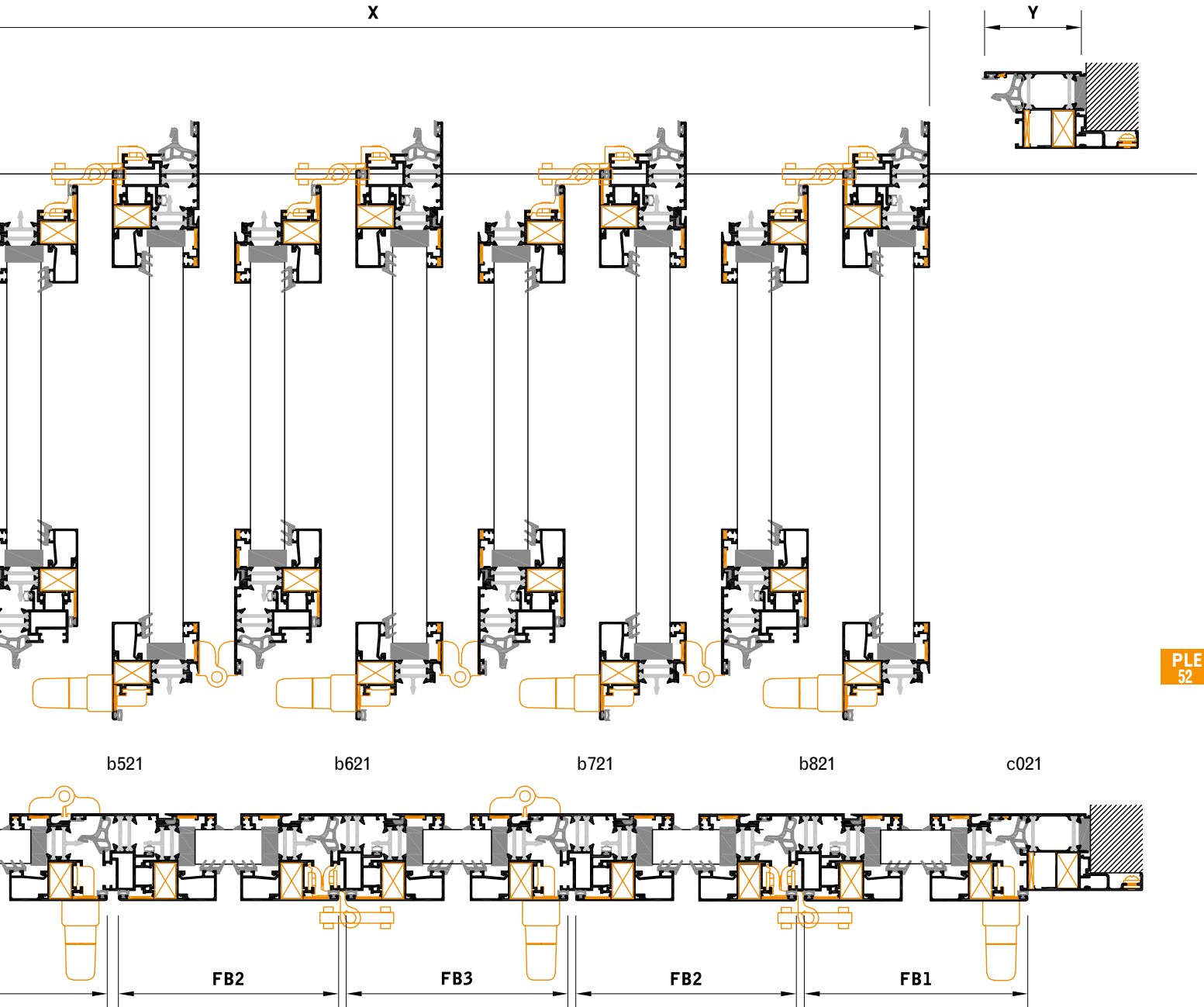
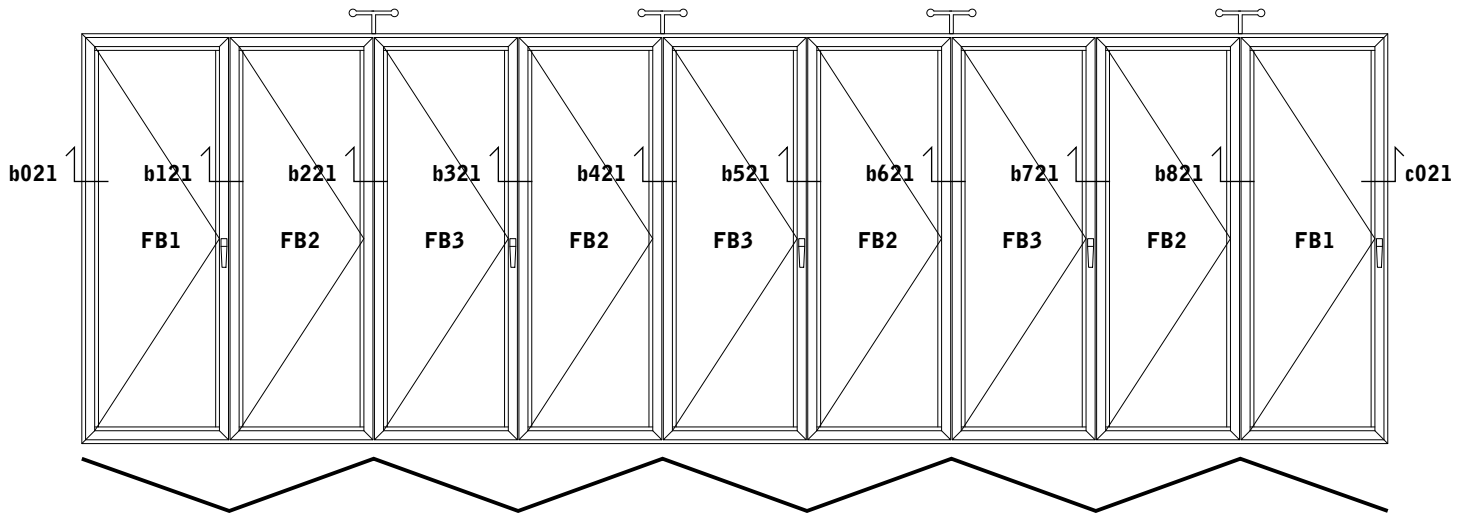

PLE
52



PLEGABLE APERTURA INTERIOR P900D1 (8 + 1)

MEDIDAS DE CORTE HOJAS Y MEDIDAS DE CRISTALES

PF43 ALFIL 45 HOJAS SISTEMA

	PF43-1190	PF43-1360/1990	PF43-1960/1990
MEDIDAS DE CORTE			
FB1	(L/9)+17,8 mm	(L/9)+17,8 mm	(L/9)+17,8 mm
FB2	(L/9)-56,5 mm	(L/9)-56,5 mm	(L/9)-56,5 mm
FB3	(L/9)+20,7 mm	(L/9)+20,7 mm	(L/9)+20,7 mm
FB4	(L/9)-45,5 mm	(L/9)-45,5 mm	(L/9)-45,5 mm
MEDIDAS DE CRISTALES			
FB1	(L/9)-94,6 mm	(L/9)-144,6 mm	(L/9)-169,5 mm
FB2	(L/9)-168,9 mm	(L/9)-218,9 mm	(L/9)-243,8 mm
FB3	(L/9)-91,7 mm	(L/9)-141,7 mm	(L/9)-143 mm
FB4	(L/9)-157,9 mm	(L/9)-207,9 mm	(L/9)-209,2 mm

PT45 / PT54 / PT80 HOJAS SISTEMA

	PTXX-1170 / 1190	PTXX-1360 / 1390	PTXX-1990
MEDIDAS DE CORTE			
FB1	(L/9)+16,5 mm	(L/9)+16,5 mm	(L/9)+16,5 mm
FB2	(L/9)-57,8 mm	(L/9)-57,8 mm	(L/9)-57,8 mm
FB3	(L/9)+19,4 mm	(L/9)+19,4 mm	(L/9)+19,4 mm
FB4	(L/9)-46,8 mm	(L/9)-46,8 mm	(L/9)-46,8 mm
MEDIDAS DE CRISTALES			
FB1	(L/9)-95,5 mm	(L/9)-145,9 mm	(L/9)-169,5 mm
FB2	(L/9)-169,8 mm	(L/9)-220,2 mm	(L/9)-243,8 mm
FB3	(L/9)-92,6 mm	(L/9)-117,2 mm	(L/9)-143 mm
FB4	(L/9)-158,8 mm	(L/9)-183,4 mm	(L/9)-209,2 mm

GROSOR HOJAS PLEGADAS

	PF43	PT45	PT54	PT80
X	625,6 mm	631,8 mm	705,4 mm	911,8 mm
Y	85,9 mm	92,1 mm	101,3 mm	127,1 mm

PESOS MÁXIMOS RECOMENDADOS POR HOJA

Tipología plegable (*)	ANCHURA / DIMENSIÓN HOJA			
	800 mm	700 mm	600 mm	500 mm
P900D1 (8 + 1) kg/hoja	15	25	35	40

(*) Para alturas mayores de 1800 mm recomendable utilizar hojas de puerta

LEYENDA: Manilla Pasador hoja pasiva Carros superiores

(1) Para hojas apertura exterior utilizar WOOR-1005 + CPAF-0651 + CPA0-9232

(2) Para hojas de puerta utilizaremos WOOR-9827H

ACCESORIOS SISTEMA

	REF	UD	H<1700 MM	H>1700 MM
MANILLAS (1)	CRAS-0760	5		
	CRAS-1760D / E	5		
	CRAS-9232	5		
PASADORES	CPAF-1508	0		
	WOOR-9826		4	6
BISAGRAS	WOOR-9826T		0	3
	WOOR-9827 (2)		8	12
	WOOR-1352	3		
JUEGO CARROS	WOOR-1352T	1		
	WOOR-1352H	0		

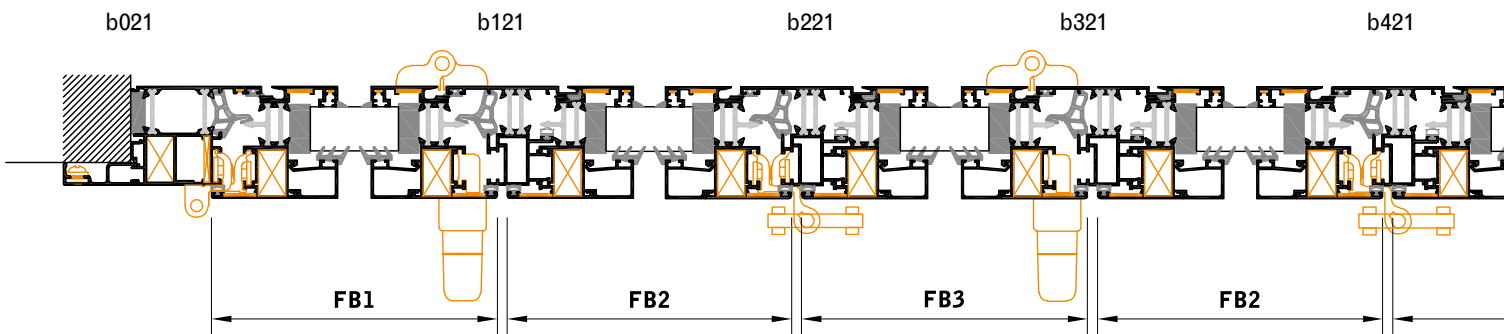
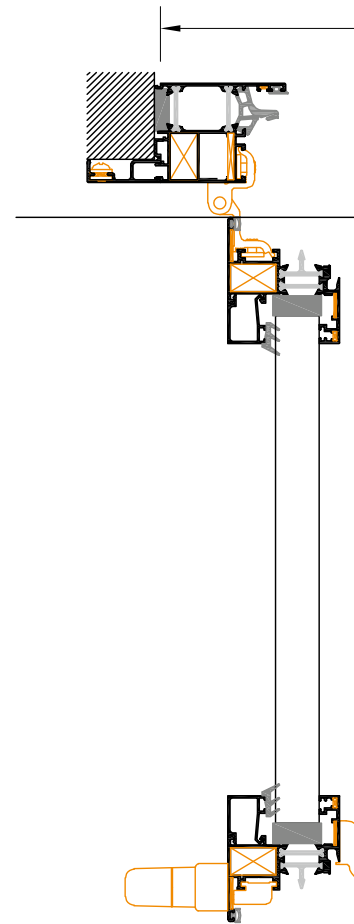

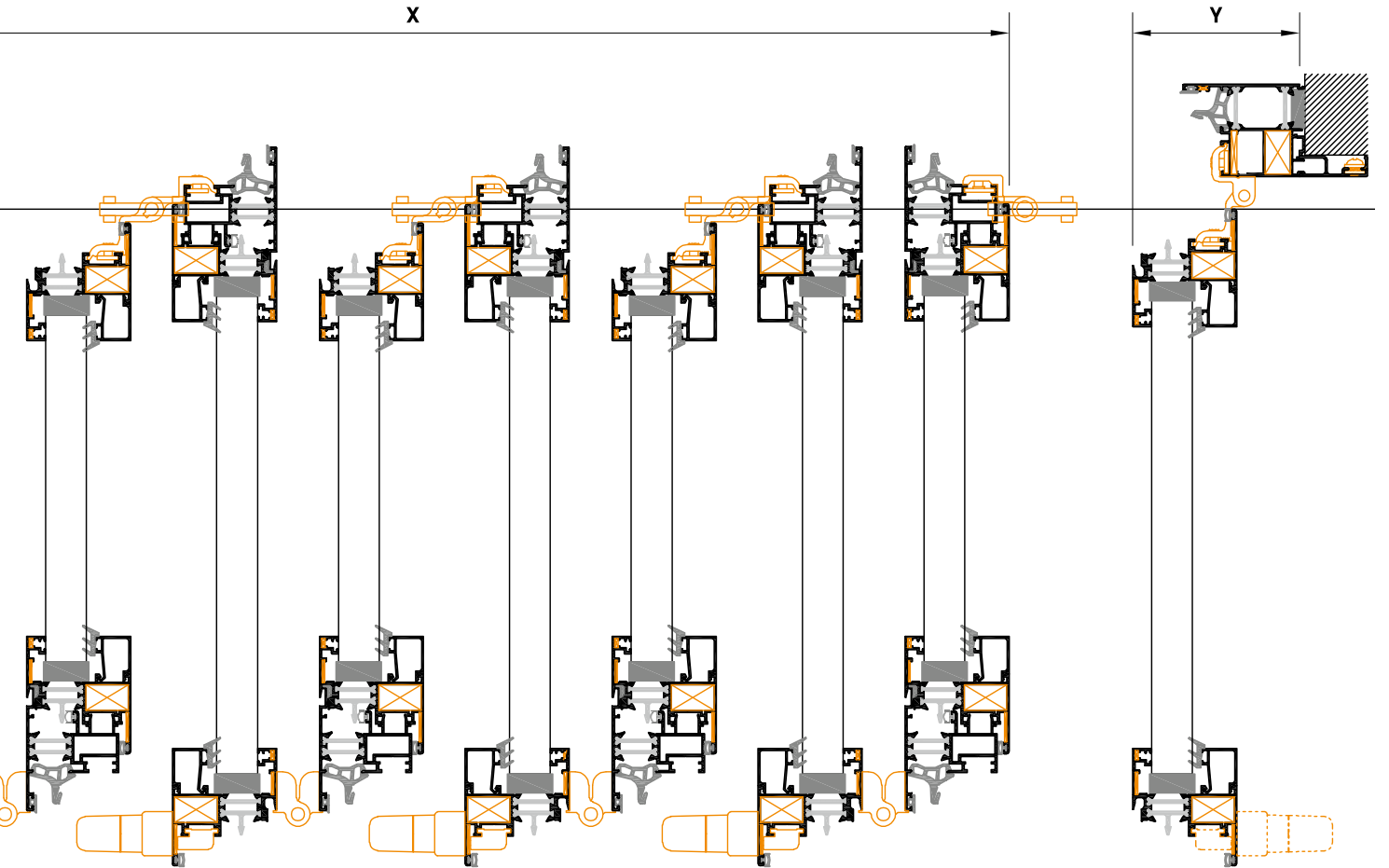
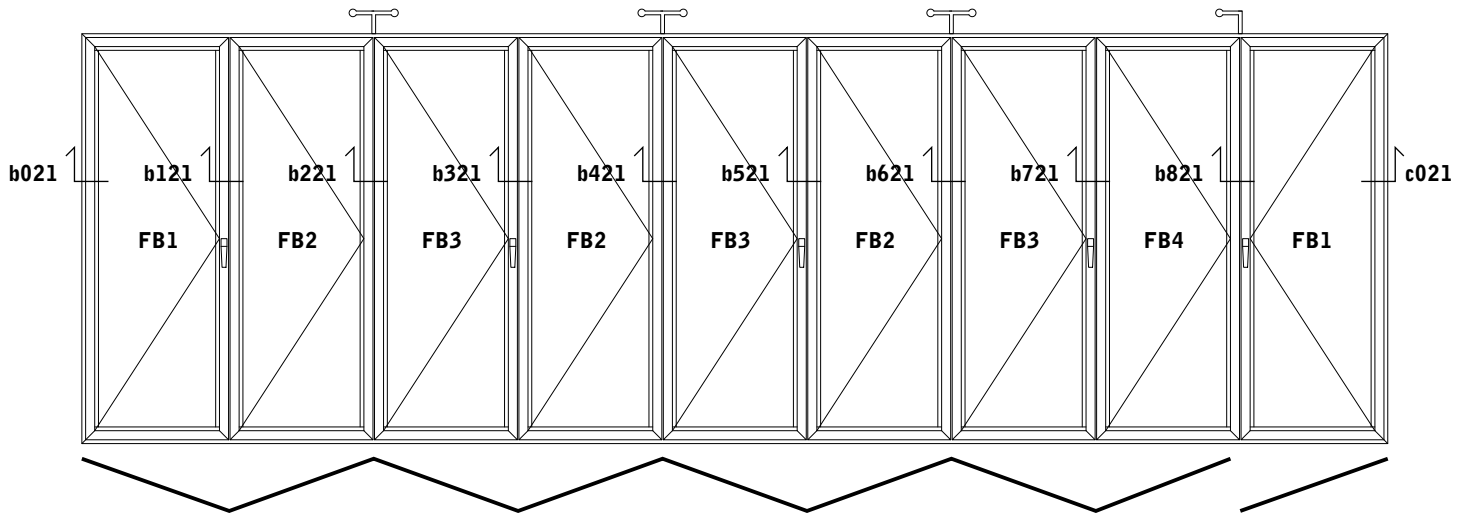

PLE
54

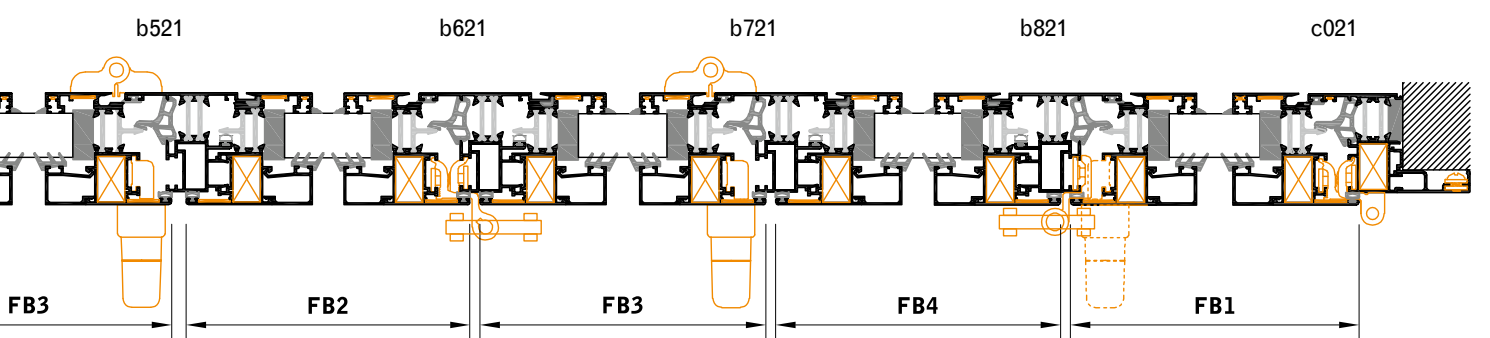



PLEGABLE APERTURA INTERIOR P900D2 (7 + 2)

MEDIDAS DE CORTE HOJAS Y MEDIDAS DE CRISTALES

PF43 ALFIL 45 HOJAS SISTEMA

	PF43-1190	PF43-1360/1990	PF43-1960/1990
MEDIDAS DE CORTE			
FB1	(L/9)+17,8 mm	(L/9)+17,8 mm	(L/9)+17,8 mm
FB2	(L/9)-56,5 mm	(L/9)-56,5 mm	(L/9)-56,5 mm
FB3	(L/9)+20,7 mm	(L/9)+20,7 mm	(L/9)+20,7 mm
FB4	(L/9)-45,5 mm	(L/9)-45,5 mm	(L/9)-45,5 mm
MEDIDAS DE CRISTALES			
FB1	(L/9)-94,6 mm	(L/9)-144,6 mm	(L/9)-169,5 mm
FB2	(L/9)-168,9 mm	(L/9)-218,9 mm	(L/9)-243,8 mm
FB3	(L/9)-91,7 mm	(L/9)-141,7 mm	(L/9)-143 mm
FB4	(L/9)-157,9 mm	(L/9)-207,9 mm	(L/9)-209,2 mm

PT45 / PT54 / PT80 HOJAS SISTEMA

	PTXX-1170 / 1190	PTXX-1360 / 1390	PTXX-1990
MEDIDAS DE CORTE			
FB1	(L/9)+16,5 mm	(L/9)+16,5 mm	(L/9)+16,5 mm
FB2	(L/9)-57,8 mm	(L/9)-57,8 mm	(L/9)-57,8 mm
FB3	(L/9)+19,4 mm	(L/9)+19,4 mm	(L/9)+19,4 mm
FB4	(L/9)-46,8 mm	(L/9)-46,8 mm	(L/9)-46,8 mm
MEDIDAS DE CRISTALES			
FB1	(L/9)-95,5 mm	(L/9)-145,9 mm	(L/9)-169,5 mm
FB2	(L/9)-169,8 mm	(L/9)-220,2 mm	(L/9)-243,8 mm
FB3	(L/9)-92,6 mm	(L/9)-117,2 mm	(L/9)-143 mm
FB4	(L/9)-158,8 mm	(L/9)-183,4 mm	(L/9)-209,2 mm

GROSOR HOJAS PLEGADAS

	PF43	PT45	PT54	PT80
X	548,5 mm	554,7 mm	619,1 mm	799,7 mm
Y	163 mm	169,2 mm <td 187,6 mm	239,2 mm	

PESOS MÁXIMOS RECOMENDADOS POR HOJA

Tipología plegable (*)	ANCHURA / DIMENSIÓN HOJA			
	800 mm	700 mm	600 mm	500 mm
P900D2 (7 + 2) kg/hoja	20	30	40	45

(*) Para alturas mayores de 1800 mm recomendable utilizar hojas de puerta

LEYENDA: Manilla Pasador hoja pasiva Carros superiores

(1) Para hojas apertura exterior utilizar WOOR-1005 + CPAF-0651 + CPA0-9232
(2) Para hojas de puerta utilizaremos WOOR-9827H

ACCESORIOS SISTEMA

	REF	UD	H<1700 MM	H>1700 MM
MANILLAS (1)	CRAS-0760	5		
	CRAS-1760D / E	5		
	CRAS-9232	5		
PASADORES	CPAF-1508	0		
BISAGRAS	WOOR-9826		4	6
	WOOR-9826T		0	3
	WOOR-9827 (2)		8	12
JUEGO CARROS	WOOR-1352	3		
	WOOR-1352T	1		
	WOOR-1352H	0		

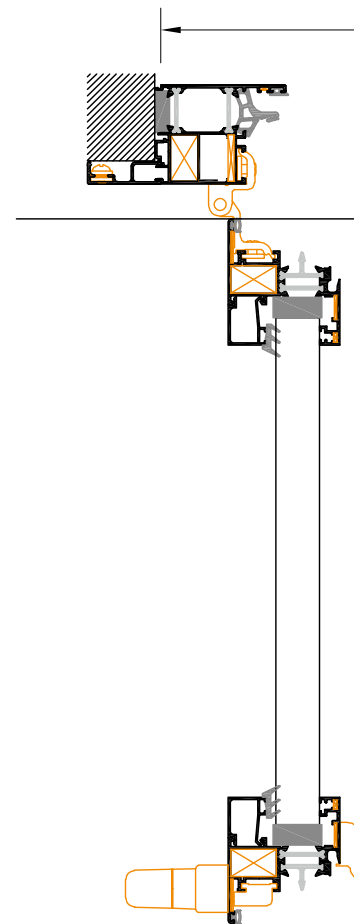

b021

b121

b221

b321

b421

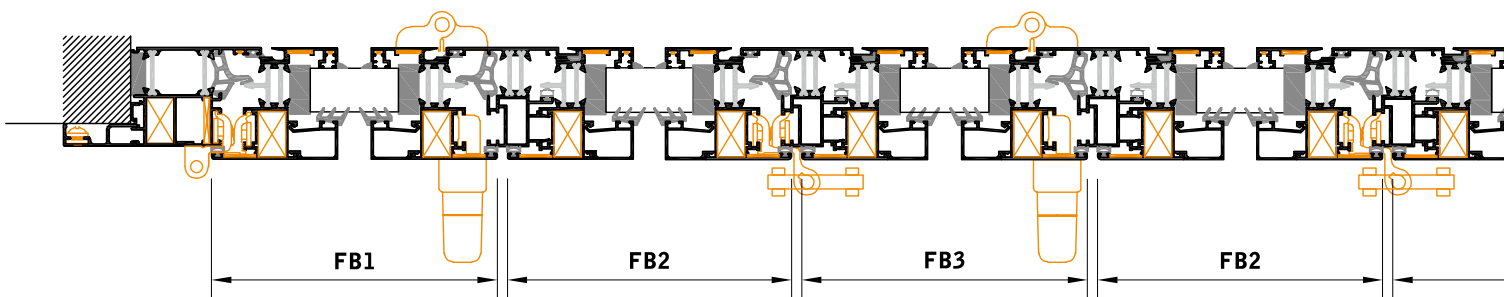

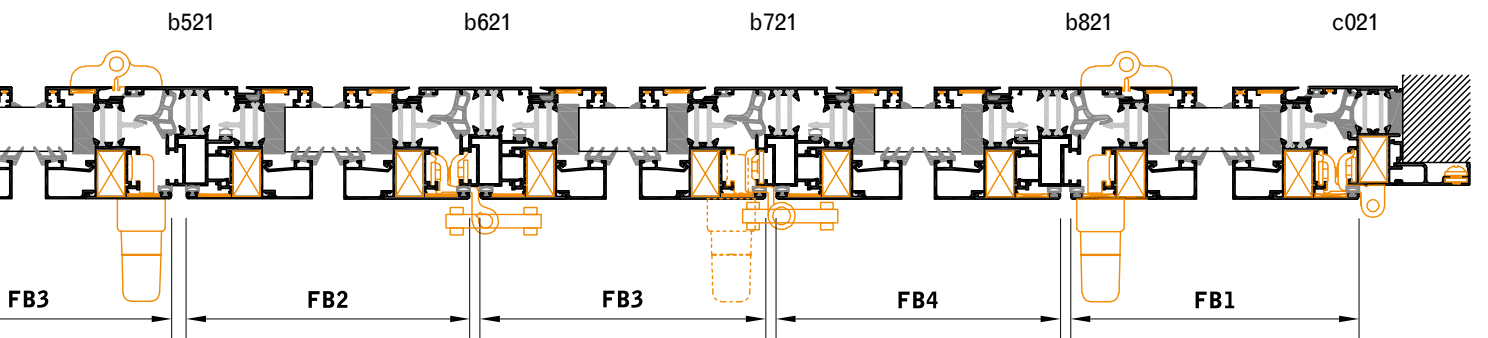
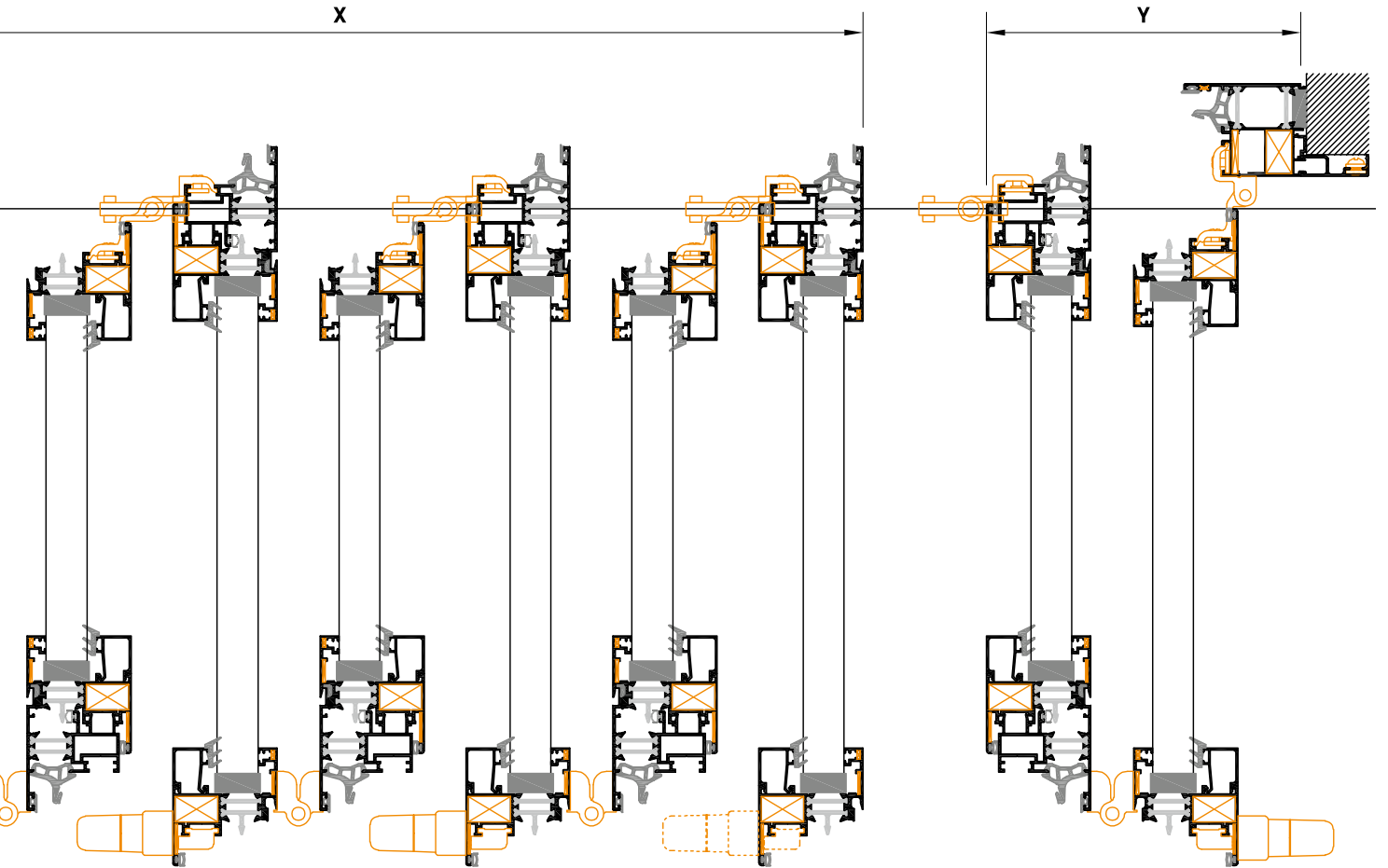
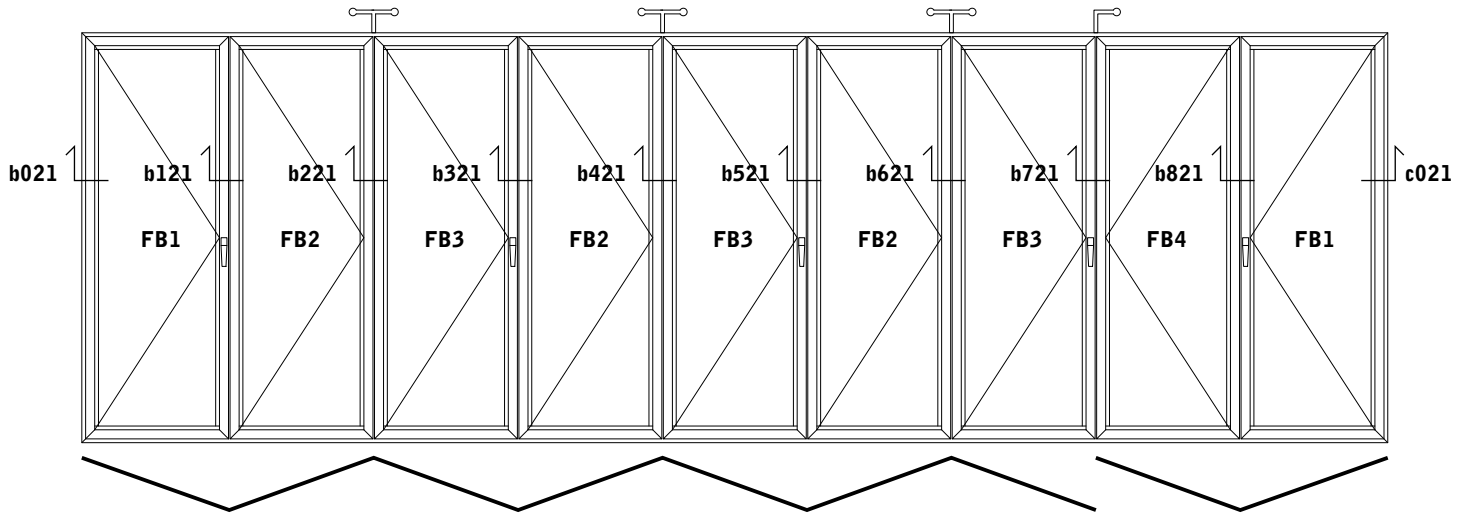

PLE
56



PLEGABLE APERTURA INTERIOR P900D3 (6 + 3)

MEDIDAS DE CORTE HOJAS Y MEDIDAS DE CRISTALES

PF43 ALFIL 45 HOJAS SISTEMA

	PF43-1190	PF43-1360/1990	PF43-1960/1990
MEDIDAS DE CORTE			
FB1	(L/9)+17,8 mm	(L/9)+17,8 mm	(L/9)+17,8 mm
FB2	(L/9)-56,5 mm	(L/9)-56,5 mm	(L/9)-56,5 mm
FB3	(L/9)+20,7 mm	(L/9)+20,7 mm	(L/9)+20,7 mm
FB4	(L/9)-45,5 mm	(L/9)-45,5 mm	(L/9)-45,5 mm
MEDIDAS DE CRISTALES			
FB1	(L/9)-94,6 mm	(L/9)-144,6 mm	(L/9)-169,5 mm
FB2	(L/9)-168,9 mm	(L/9)-218,9 mm	(L/9)-243,8 mm
FB3	(L/9)-91,7 mm	(L/9)-141,7 mm	(L/9)-143 mm
FB4	(L/9)-157,9 mm	(L/9)-207,9 mm	(L/9)-209,2 mm

PT45 / PT54 / PT80 HOJAS SISTEMA

	PTXX-1170 / 1190	PTXX-1360 / 1390	PTXX-1990
MEDIDAS DE CORTE			
FB1	(L/9)+16,5 mm	(L/9)+16,5 mm	(L/9)+16,5 mm
FB2	(L/9)-57,8 mm	(L/9)-57,8 mm	(L/9)-57,8 mm
FB3	(L/9)+19,4 mm	(L/9)+19,4 mm	(L/9)+19,4 mm
FB4	(L/9)-46,8 mm	(L/9)-46,8 mm	(L/9)-46,8 mm
MEDIDAS DE CRISTALES			
FB1	(L/9)-95,5 mm	(L/9)-145,9 mm	(L/9)-169,5 mm
FB2	(L/9)-169,8 mm	(L/9)-220,2 mm	(L/9)-243,8 mm
FB3	(L/9)-92,6 mm	(L/9)-117,2 mm	(L/9)-143 mm
FB4	(L/9)-158,8 mm	(L/9)-183,4 mm	(L/9)-209,2 mm

GROSOR HOJAS PLEGADAS

	PF43	PT45	PT54	PT80
X	471,4 mm	477,6 mm	532,8 mm	687,6 mm
Y	240,1 mm	246,3 mm	273,9 mm	351,3 mm

PESOS MÁXIMOS RECOMENDADOS POR HOJA

Tipología plegable (*)	ANCHURA / DIMENSIÓN HOJA			
	800 mm	700 mm	600 mm	500 mm
P900D3 (6 + 3) kg/hoja	30	45	50	55

(*) Para alturas mayores de 1800 mm recomendable utilizar hojas de puerta

LEYENDA: Manilla Pasador hoja pasiva Carros superiores

(1) Para hojas apertura exterior utilizar WOOR-1005 + CPAF-0651 + CPA0-9232

(2) Para hojas de puerta utilizaremos WOOR-9827H

ACCESORIOS SISTEMA

	REF	UD	H<1700 MM	H>1700 MM
MANILLAS (1)	CRAS-0760	5		
	CRAS-1760D / E	5		
	CRAS-9232	5		
PASADORES	CPAF-1508	0		
BISAGRAS	WOOR-9826		4	6
	WOOR-9826T		0	3
	WOOR-9827 (2)		8	12
JUEGO CARROS	WOOR-1352	3		
	WOOR-1352T	1		
	WOOR-1352H	0		

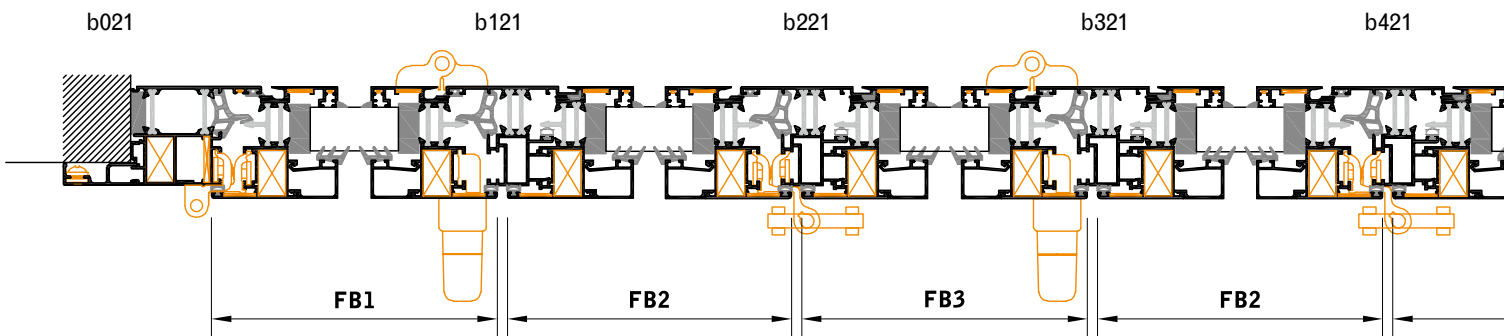
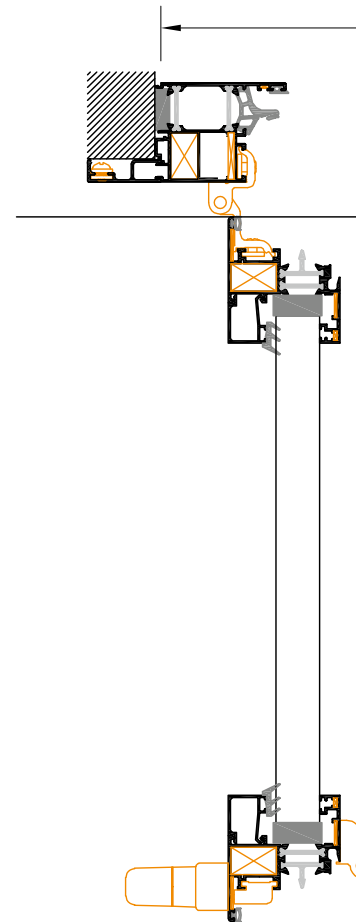

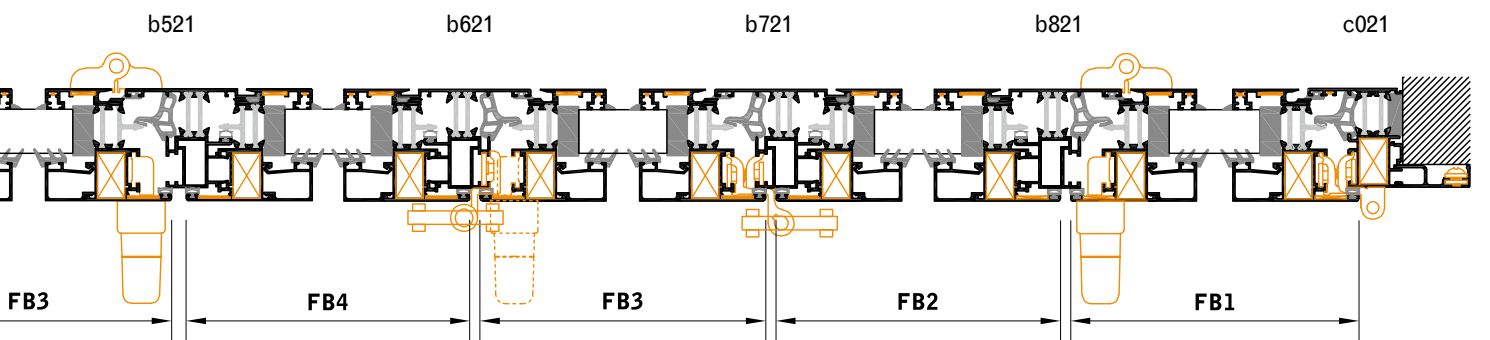
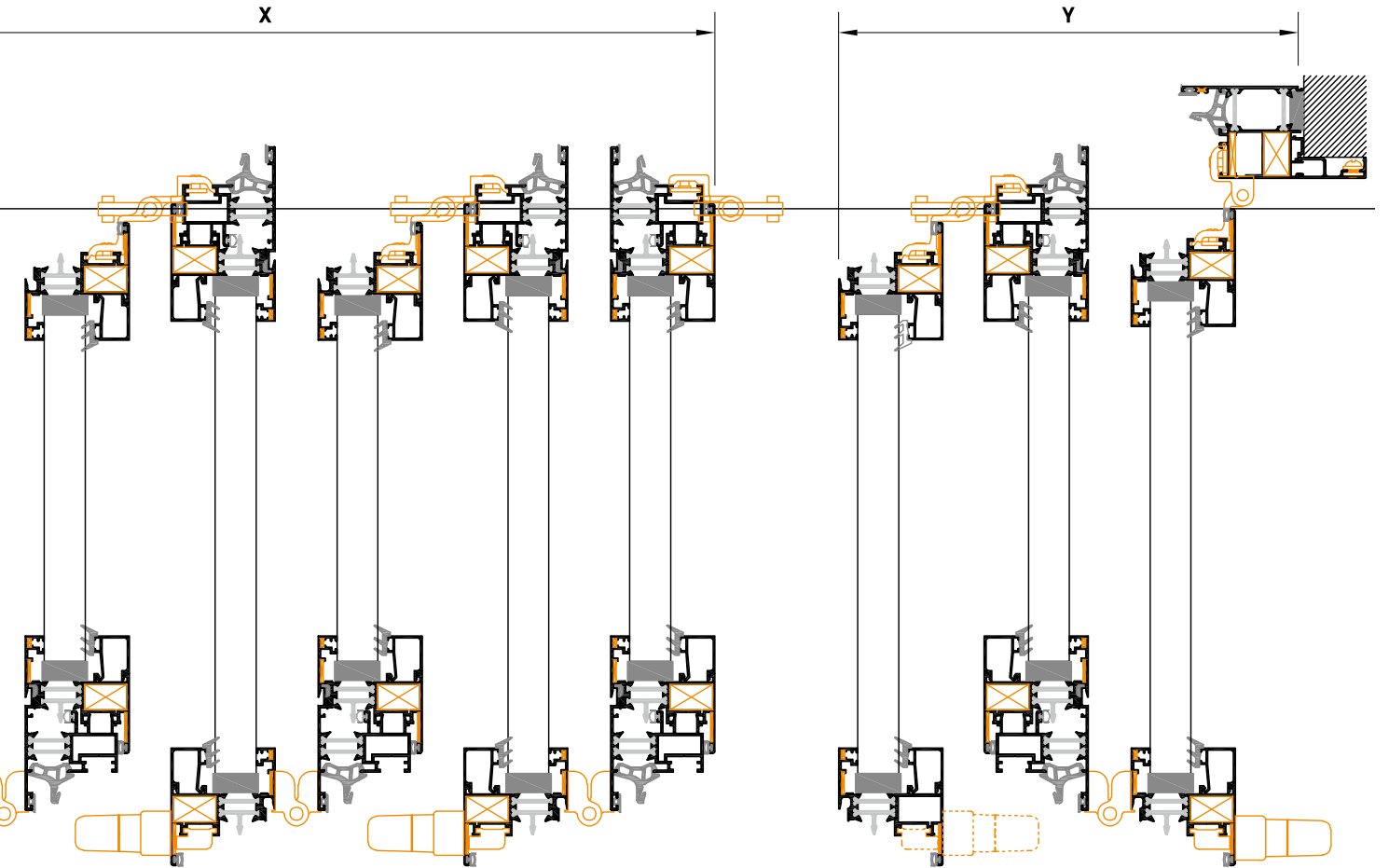
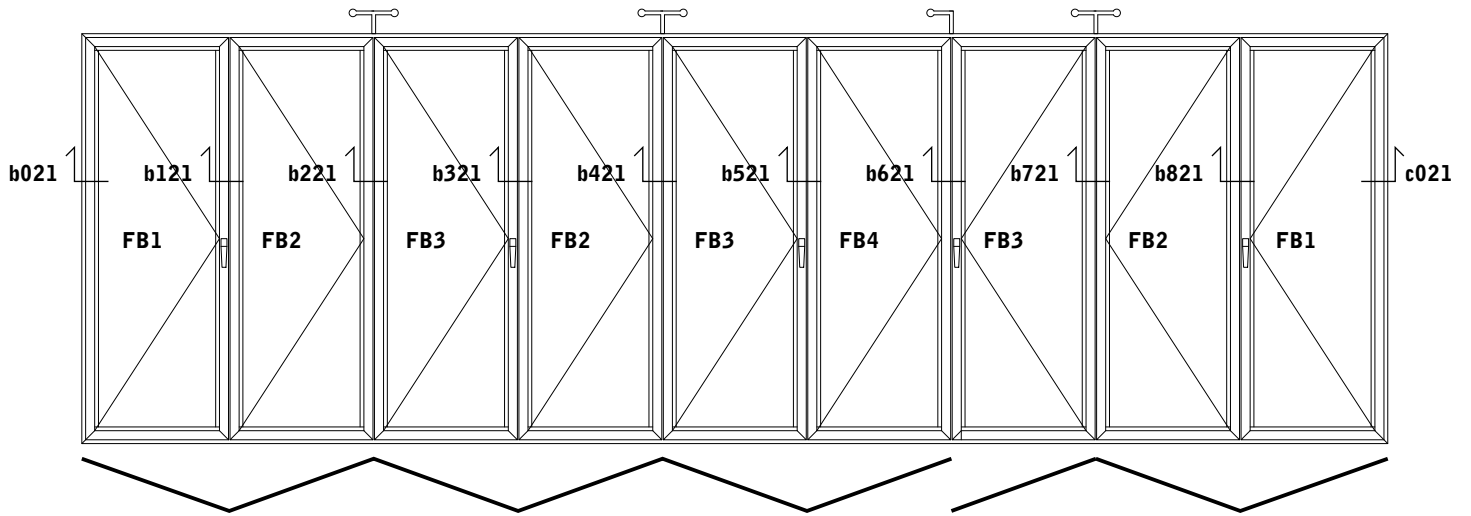

PLE
58



PLEGABLE APERTURA INTERIOR P900D4 (5 + 4)

MEDIDAS DE CORTE HOJAS Y MEDIDAS DE CRISTALES

PF43 ALFIL 45 HOJAS SISTEMA

	PF43-1190	PF43-1360/1990	PF43-1960/1990
MEDIDAS DE CORTE			
FB1	(L/9)+17,8 mm	(L/9)+17,8 mm	(L/9)+17,8 mm
FB2	(L/9)-56,5 mm	(L/9)-56,5 mm	(L/9)-56,5 mm
FB3	(L/9)+20,7 mm	(L/9)+20,7 mm	(L/9)+20,7 mm
FB4	(L/9)-45,5 mm	(L/9)-45,5 mm	(L/9)-45,5 mm
MEDIDAS DE CRISTALES			
FB1	(L/9)-94,6 mm	(L/9)-144,6 mm	(L/9)-169,5 mm
FB2	(L/9)-168,9 mm	(L/9)-218,9 mm	(L/9)-243,8 mm
FB3	(L/9)-91,7 mm	(L/9)-141,7 mm	(L/9)-143 mm
FB4	(L/9)-157,9 mm	(L/9)-207,9 mm	(L/9)-209,2 mm

PT45 / PT54 / PT80 HOJAS SISTEMA

	PTXX-1170 / 1190	PTXX-1360 / 1390	PTXX-1990
MEDIDAS DE CORTE			
FB1	(L/9)+16,5 mm	(L/9)+16,5 mm	(L/9)+16,5 mm
FB2	(L/9)-57,8 mm	(L/9)-57,8 mm	(L/9)-57,8 mm
FB3	(L/9)+19,4 mm	(L/9)+19,4 mm	(L/9)+19,4 mm
FB4	(L/9)-46,8 mm	(L/9)-46,8 mm	(L/9)-46,8 mm
MEDIDAS DE CRISTALES			
FB1	(L/9)-95,5 mm	(L/9)-145,9 mm	(L/9)-169,5 mm
FB2	(L/9)-169,8 mm	(L/9)-220,2 mm	(L/9)-243,8 mm
FB3	(L/9)-92,6 mm	(L/9)-117,2 mm	(L/9)-143 mm
FB4	(L/9)-158,8 mm	(L/9)-183,4 mm	(L/9)-209,2 mm

GROSOR HOJAS PLEGADAS

	PF43	PT45	PT54	PT80
X	394,3 mm	400,5 mm	446,5 mm	575,5 mm
Y	317,2 mm	323,4 mm	360,2 mm	463,4 mm

PESOS MÁXIMOS RECOMENDADOS POR HOJA

	ANCHURA / DIMENSIÓN HOJA			
Tipología plegable (*)	800 mm	700 mm	600 mm	500 mm
P900D4 (5 + 4) kg/hoja	25	35	45	50

(*) Para alturas mayores de 1800 mm recomendable utilizar hojas de puerta

LEYENDA: Manilla Pasador hoja pasiva Carros superiores

(1) Para hojas apertura exterior utilizar WOOR-1005 + CPAF-0651 + CPA0-9232

(2) Para hojas de puerta utilizaremos WOOR-9827H

ACCESORIOS SISTEMA

	REF	UD	H<1700 MM	H>1700 MM
MANILLAS (1)	CRAS-0760	5		
	CRAS-1760D / E	5		
	CRAS-9232	5		
PASADORES	CPAF-1508	0		
BISAGRAS	WOOR-9826		4	6
	WOOR-9826T		0	3
	WOOR-9827 (2)		8	12
JUEGO CARROS	WOOR-1352	3		
	WOOR-1352T	1		
	WOOR-1352H	0		

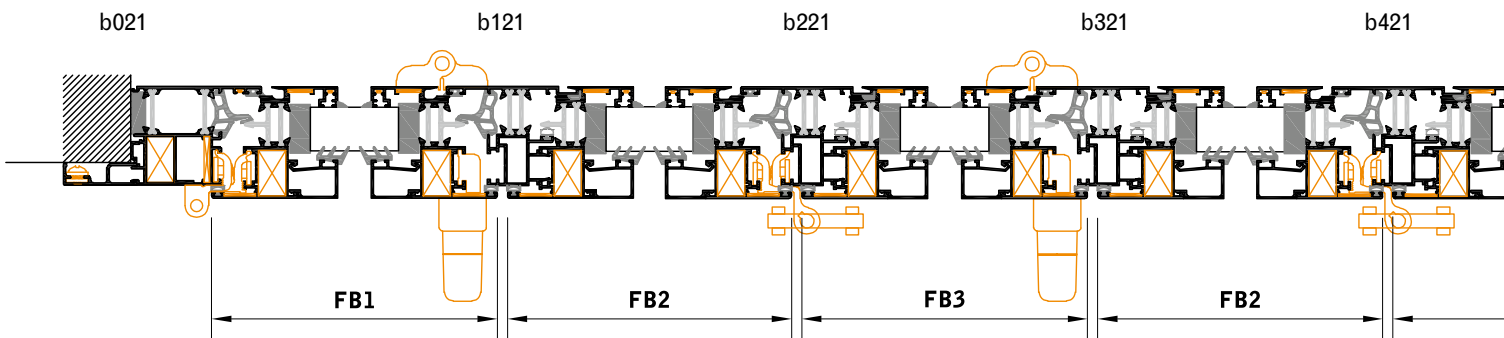
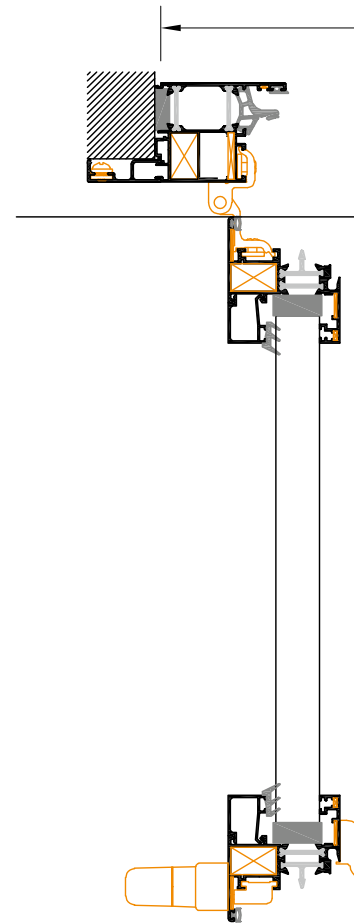

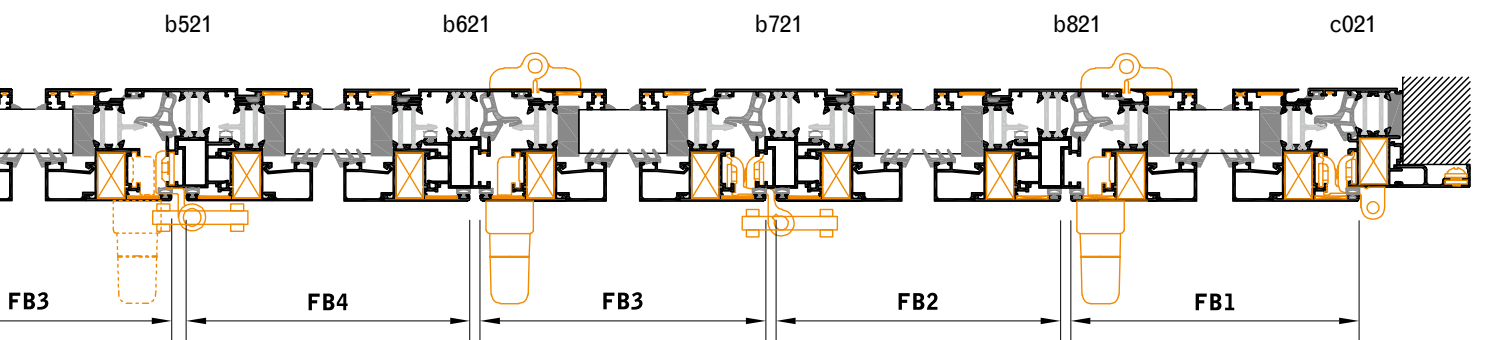
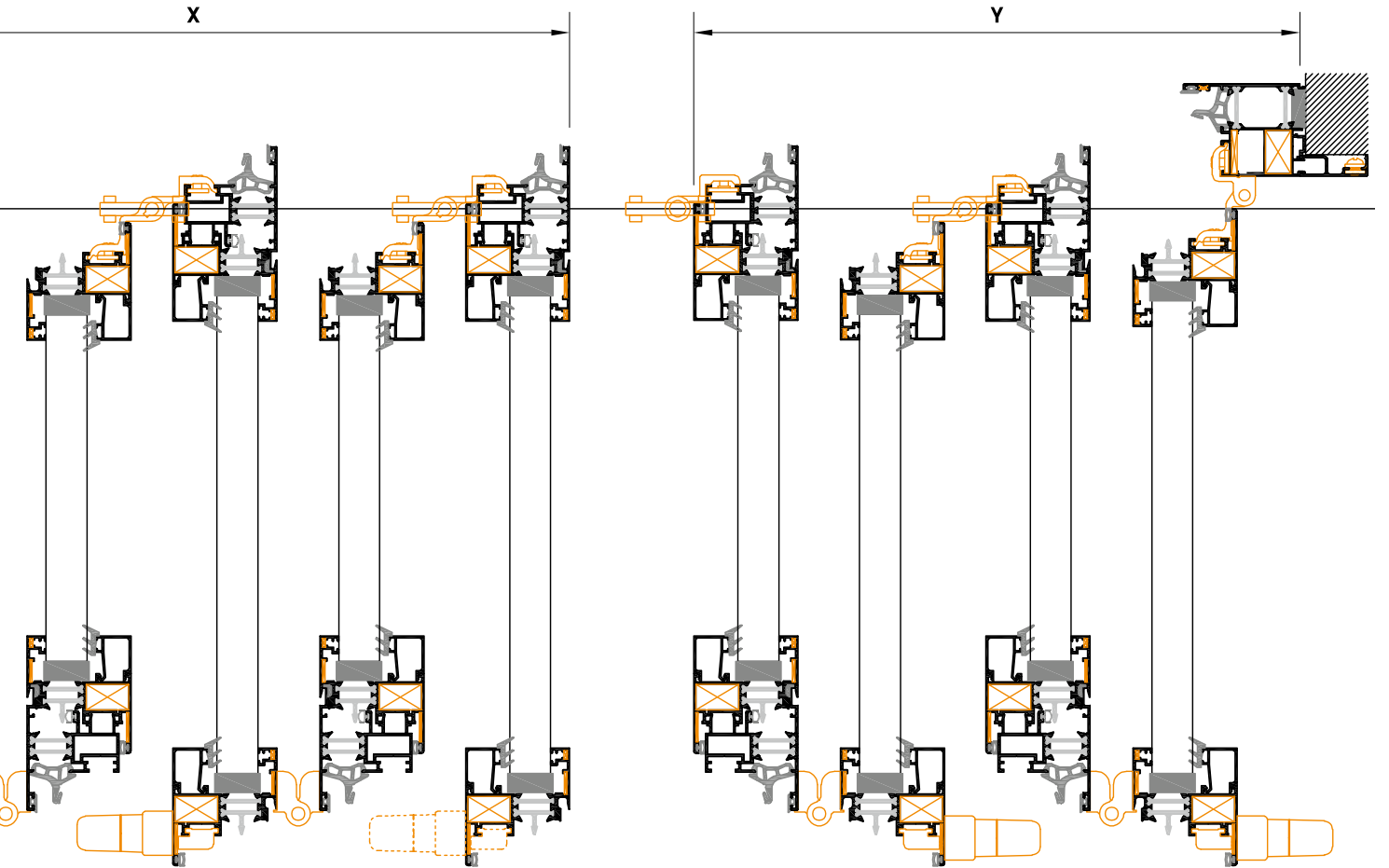
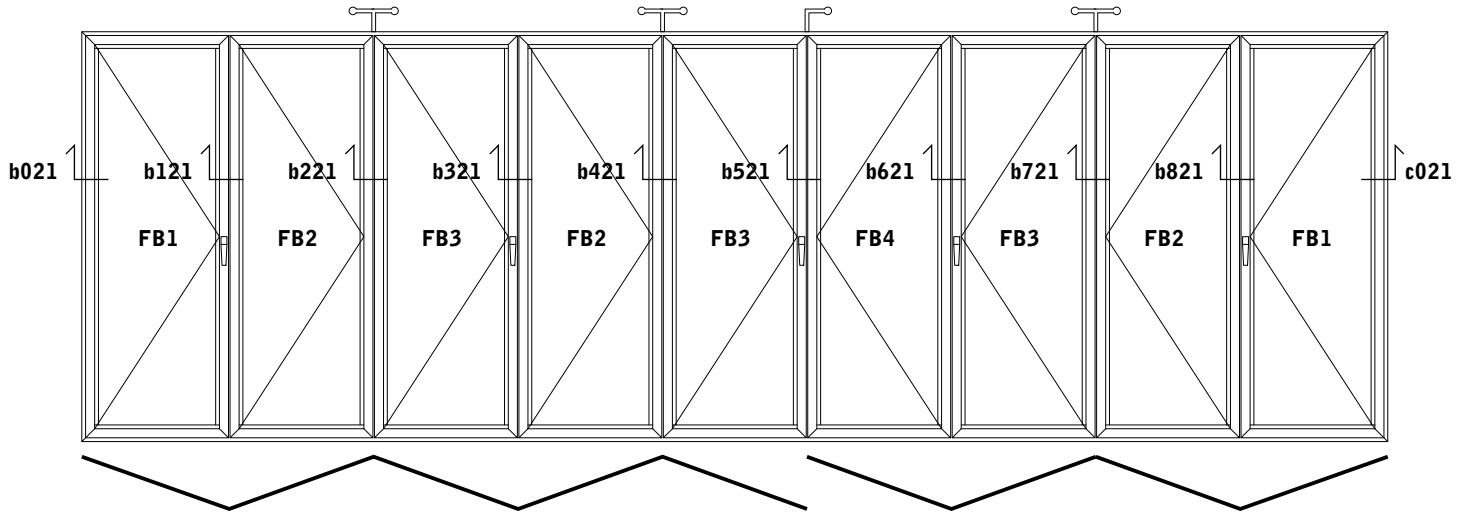

PLE
60

PLEGABLE CON MARCO CERRADOY GUÍA SOBREPUESTA

PF43 (WOOR-9092; WOOR-9091)

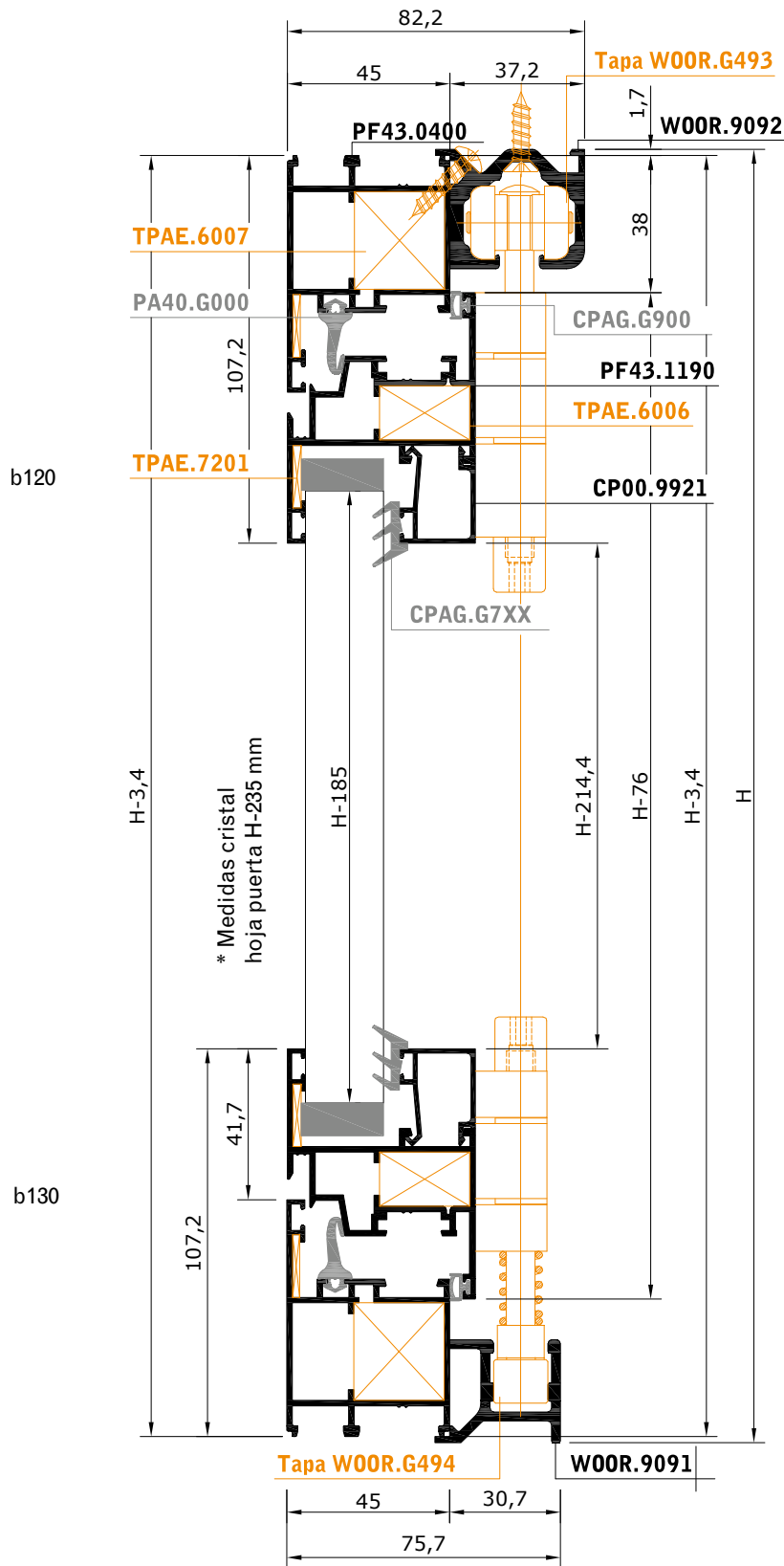

SECCIÓN VERTICAL b120-b130

PLEGABLE CON ZÓCALO Y GUÍA EMPOTRADA

PF43 (WOOR-9092; OM60-9091)

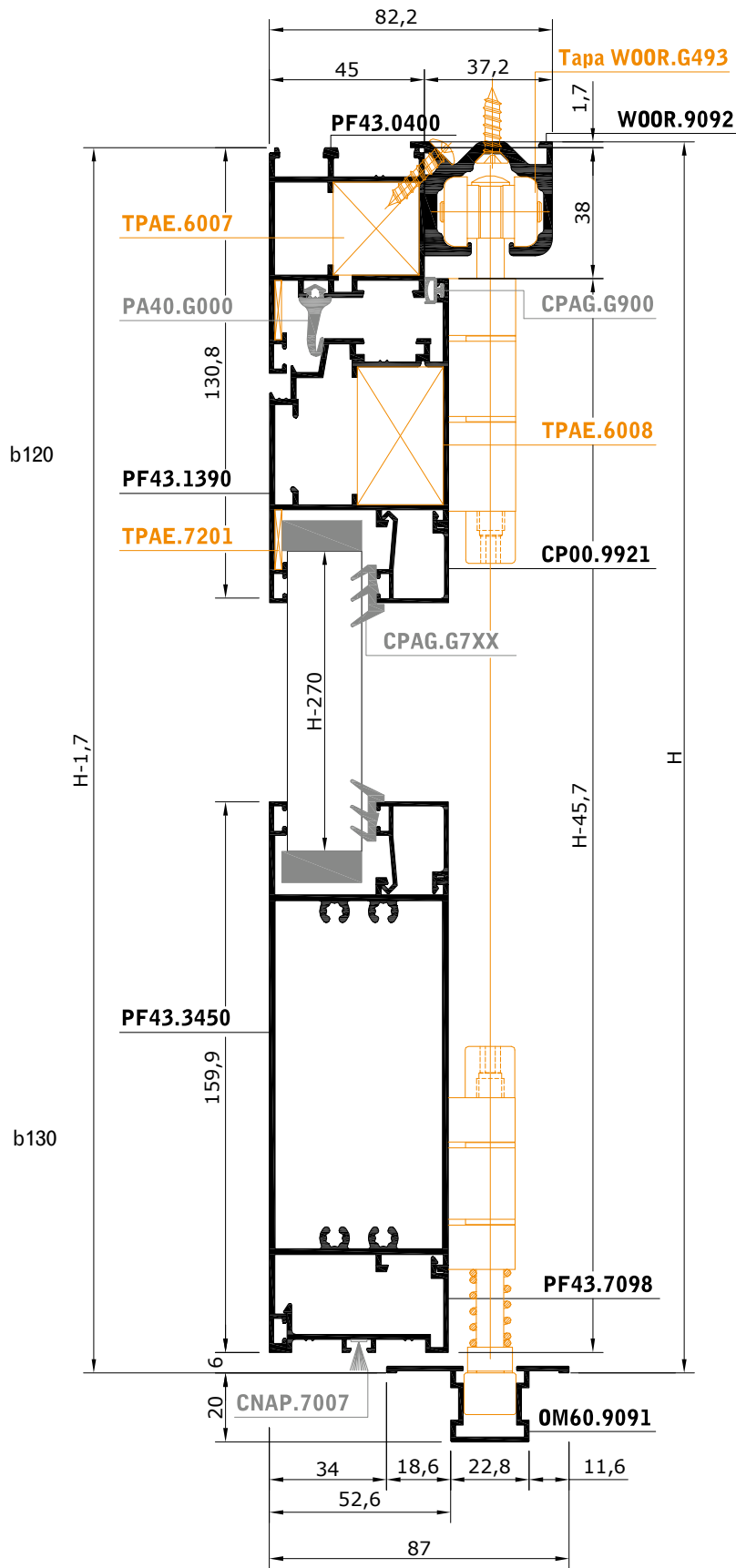

SECCIÓN VERTICAL b120-b130



PLEGABLE CON MARCO CERRADOY GUÍA SOBREPUESTA

PT45 (WOOR-9092;WOOR-9091)

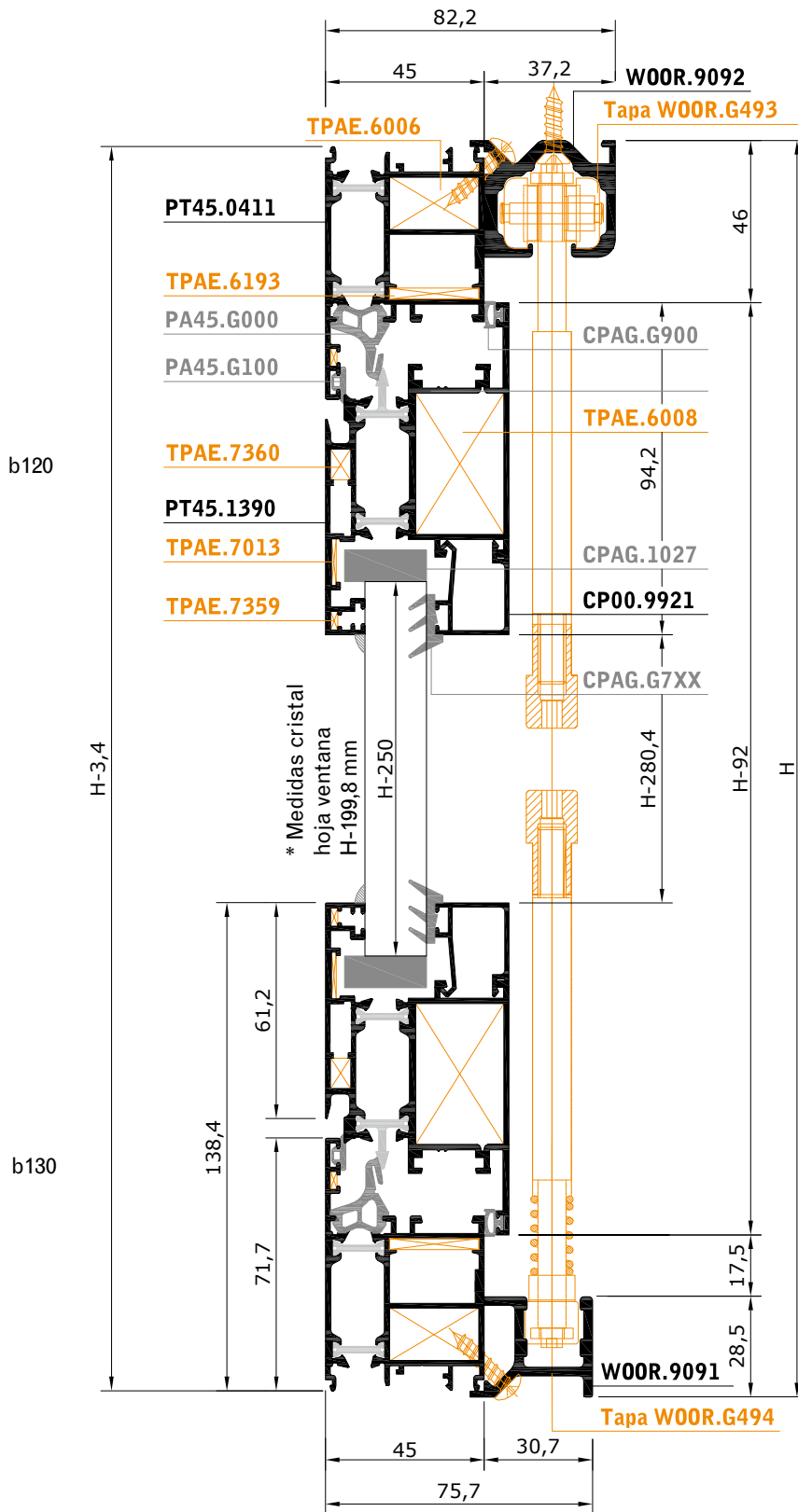

SECCIÓN VERTICAL b120-b130

PLEGABLE CON ZÓCALO Y GUÍA EMPOTRADA

PT45 (WOOR-9092;OM60-9091)

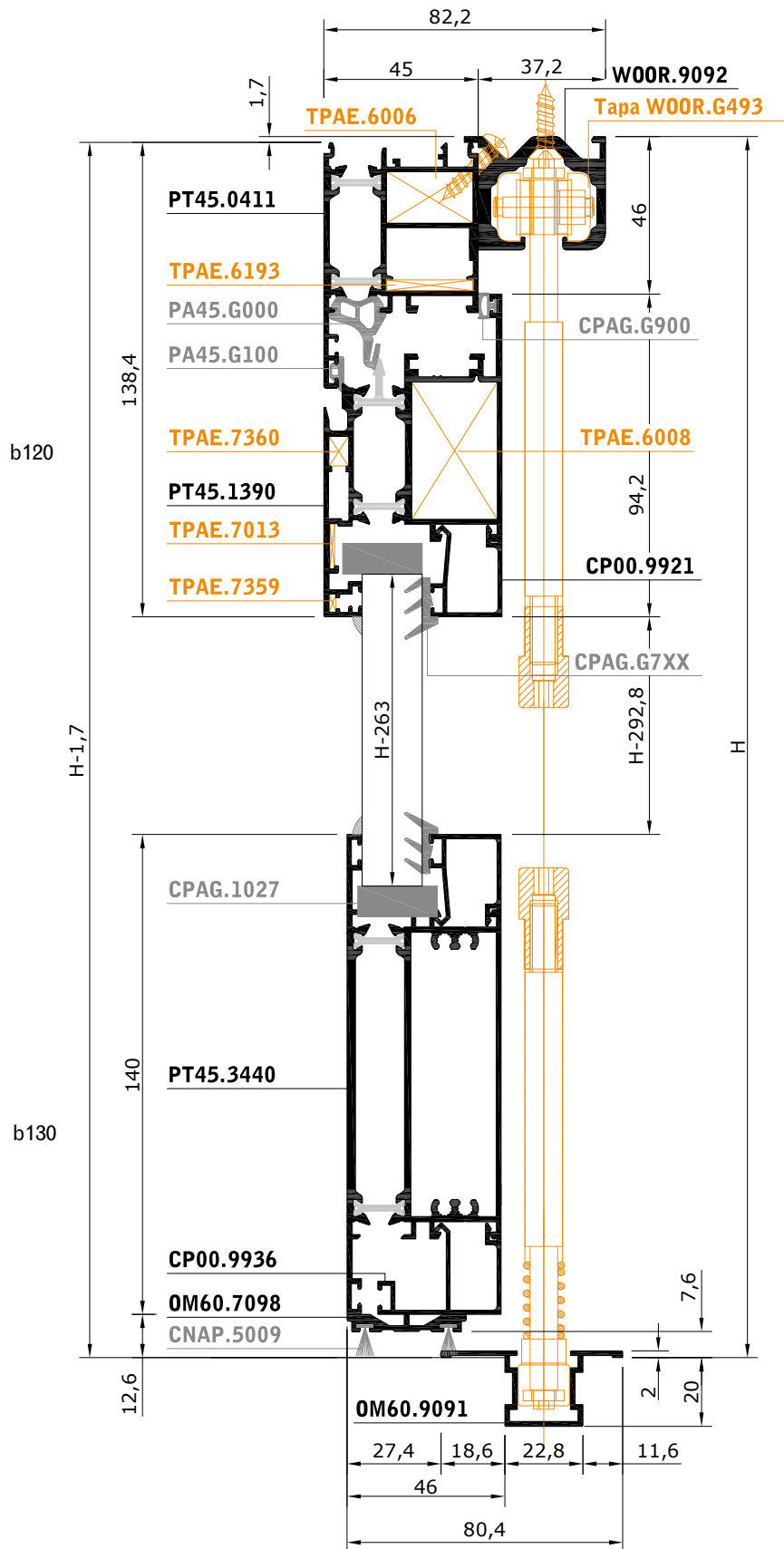

SECCIÓN VERTICAL b_{120} - b_{130}



PLEGABLE CON GUÍA EMPOTRADA

PT45 (WOOR-9092;OM60-9091)

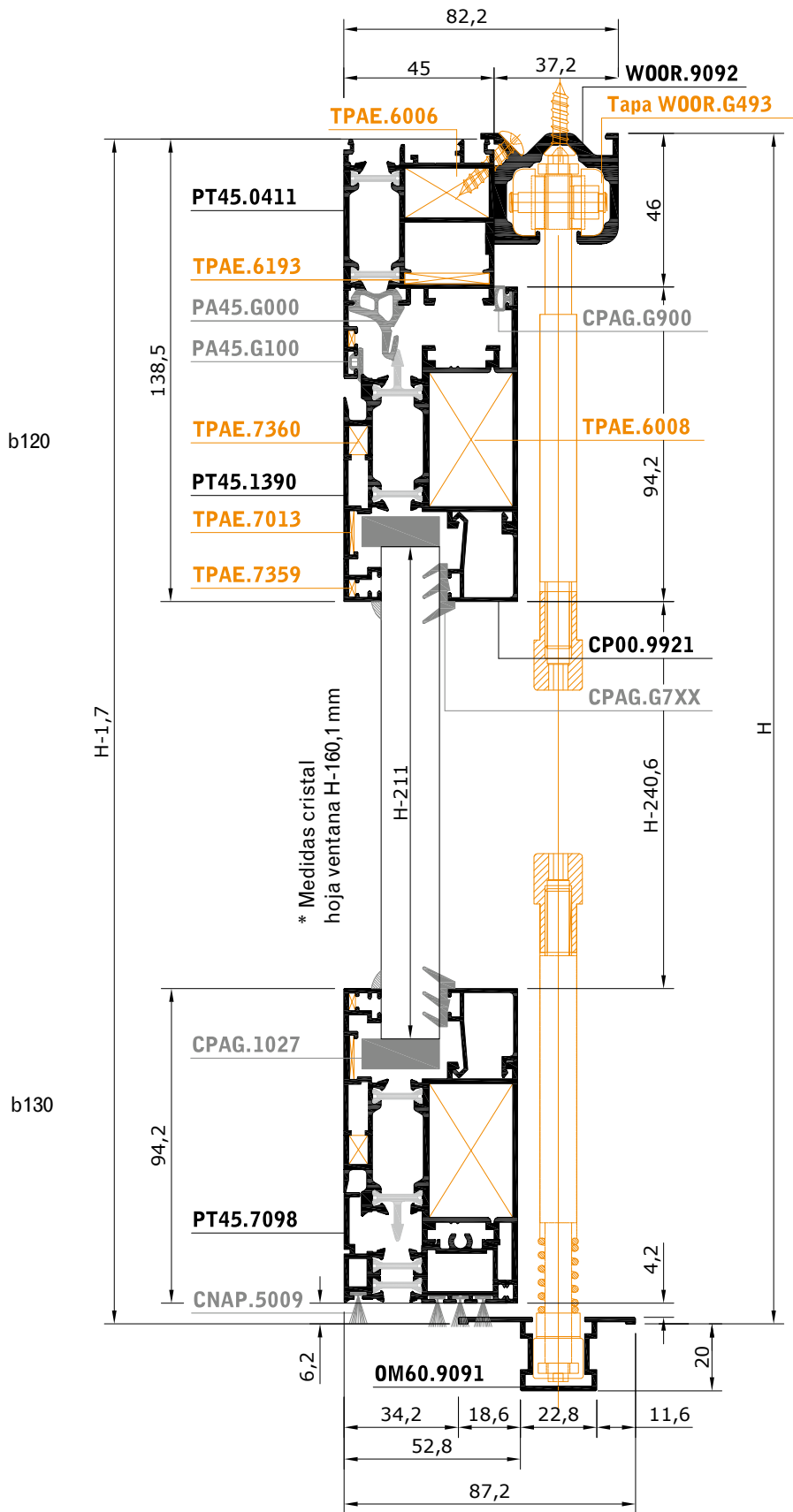

SECCIÓN VERTICAL b120-b130



PLEGABLE CON MARCO CERRADO Y GUÍA SOBREPUESTA

PT54 (WOOR-9092;WOOR-9091)

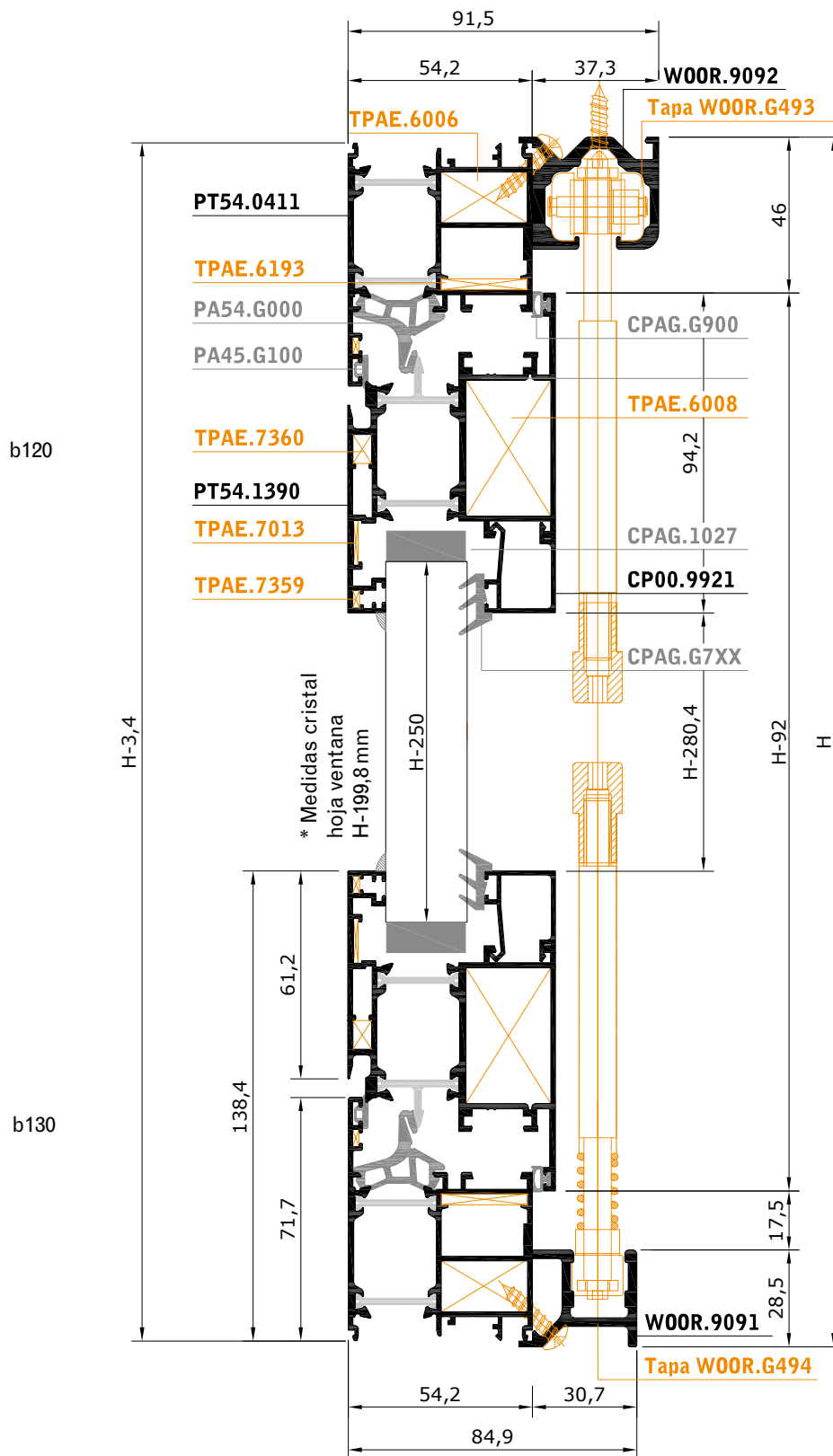

SECCIÓN VERTICAL b120-b130



PLEGABLE CON ZÓCALO Y GUÍA EMPOTRADA
PT54 (WOOR-9092;OM60-9091)

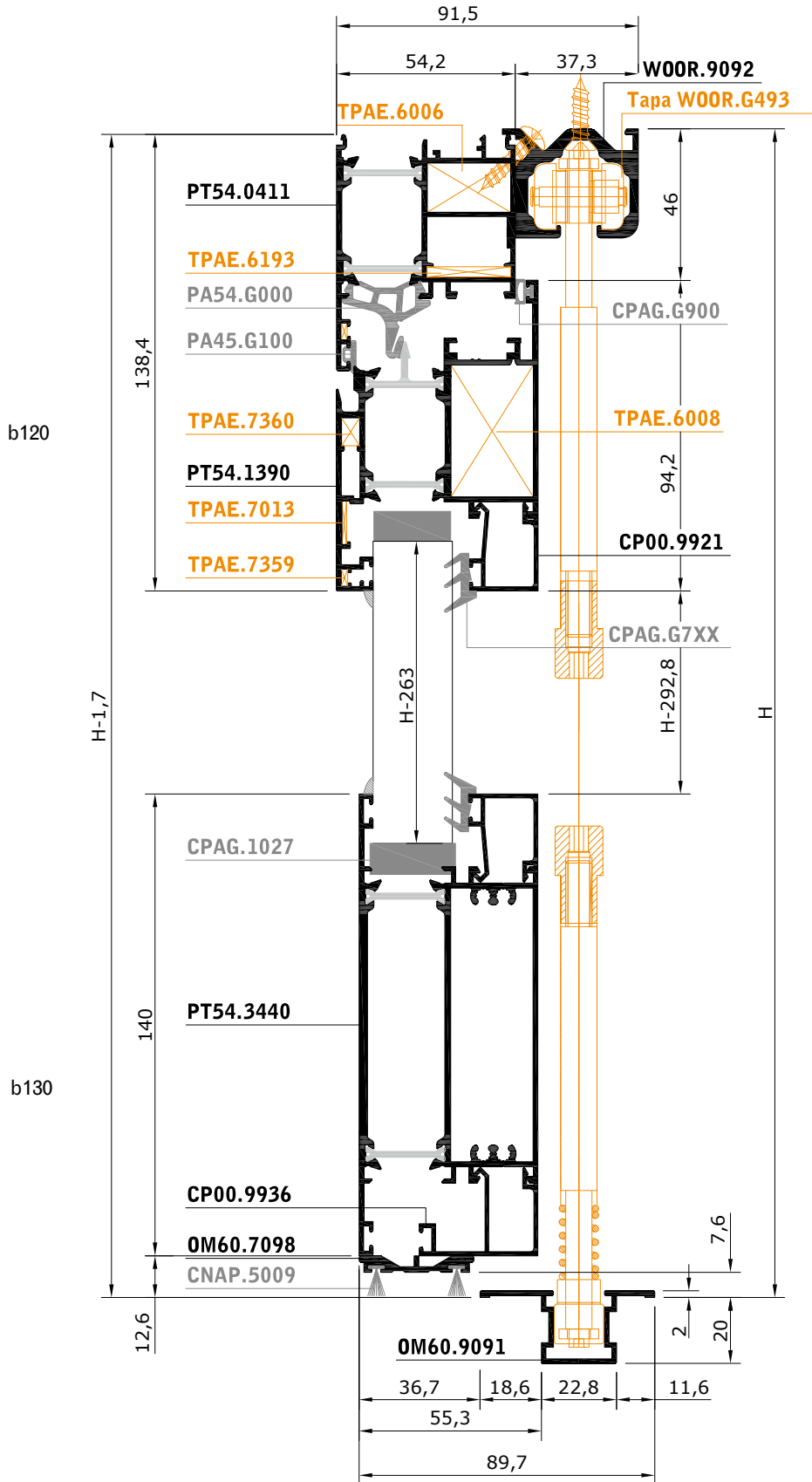

SECCIÓN VERTICAL b120-b130



PLEGABLE CON MARCO CERRADO Y GUÍA SOBREPUESTA

PT54 (WOOR.9092;OM60.0800)

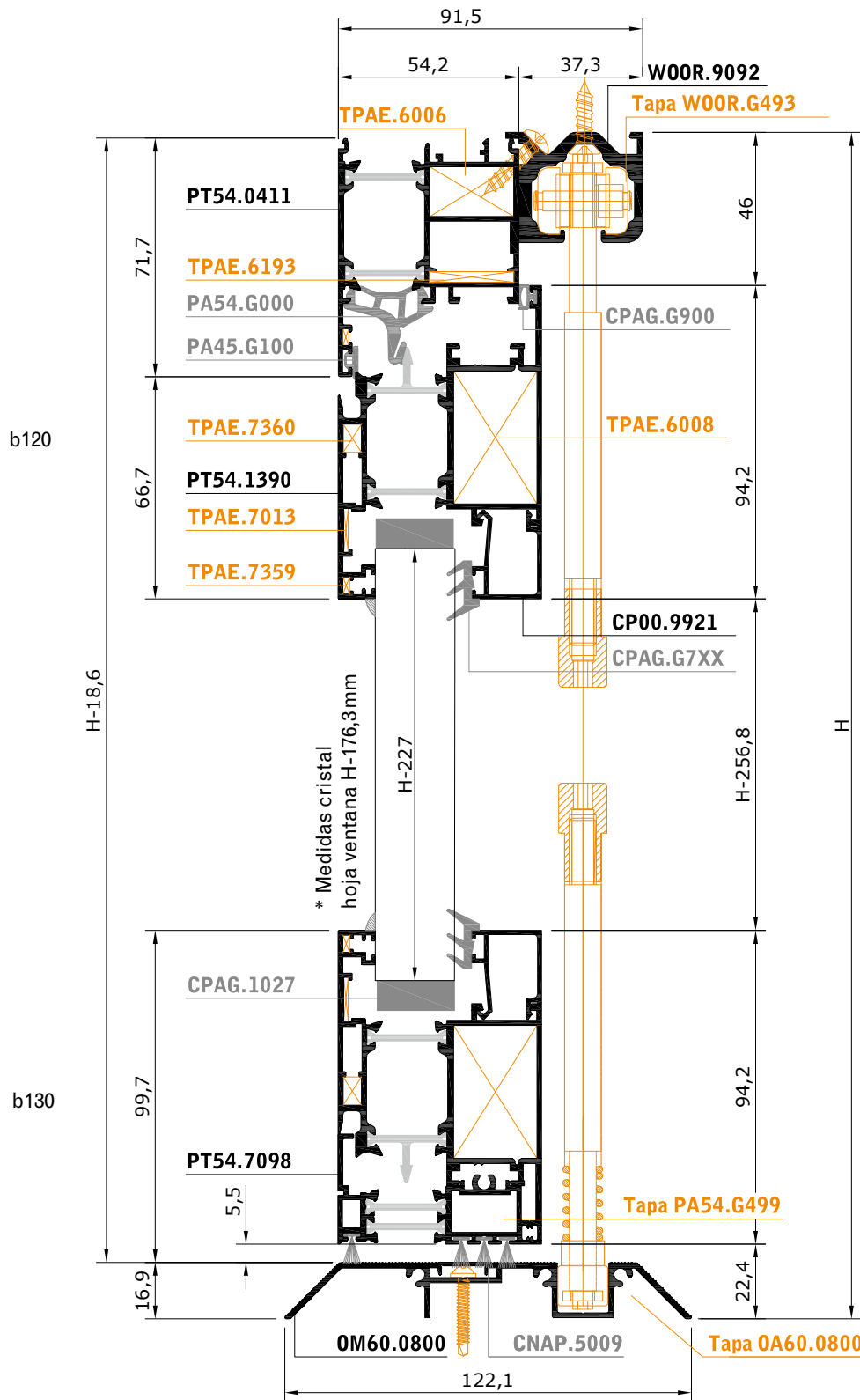

SECCIÓN VERTICAL b120-b130

PLE
70



PLEGABLE CON MARCO CERRADOY GUÍA SOBREPUESTA. APERTURA EXTERIOR
PF43 (WOOR-9092; WOOR-9091)

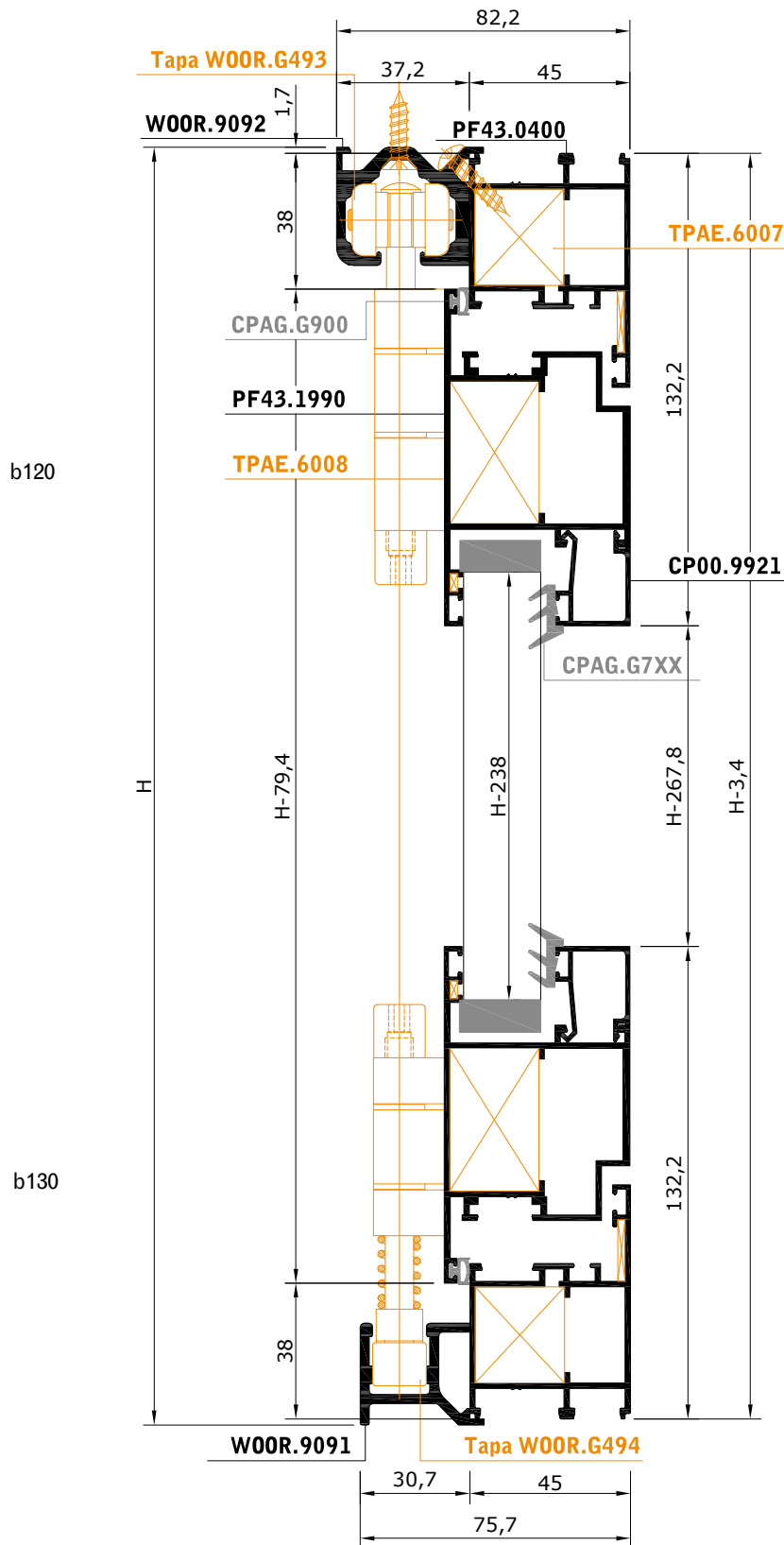

SECCIÓN VERTICAL b120-b130



PLEGABLE CON ZÓCALO Y GUÍA EMPOTRADA. APERTURA EXTERIOR

PF43 (WOOR-9092; OM60-9091)

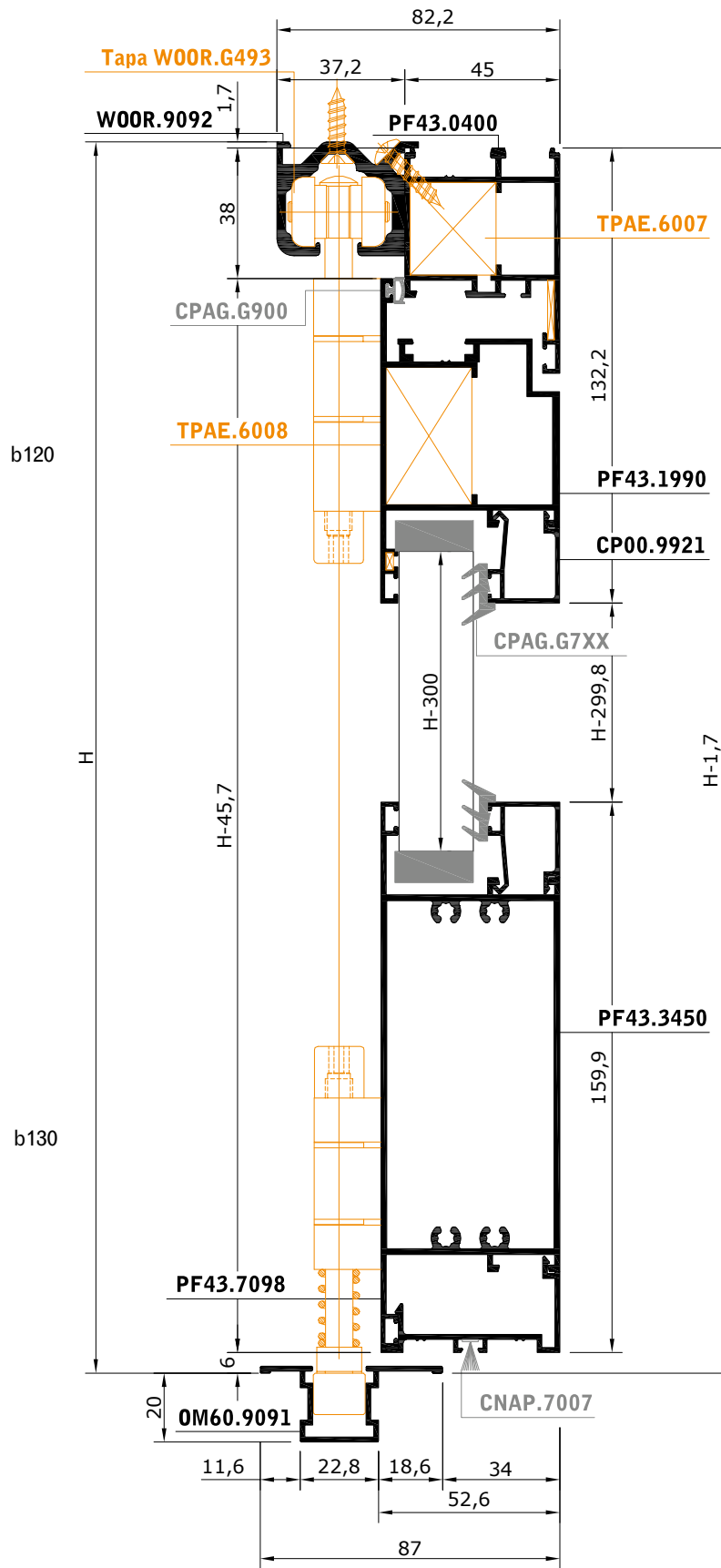

SECCIÓN VERTICAL b120-b130

PLE
72



PLEGABLE CON ZÓCALO Y GUÍA EMPOTRADA. APERTURA EXTERIOR
PT54 (WOOR-9092;OM60-9091)

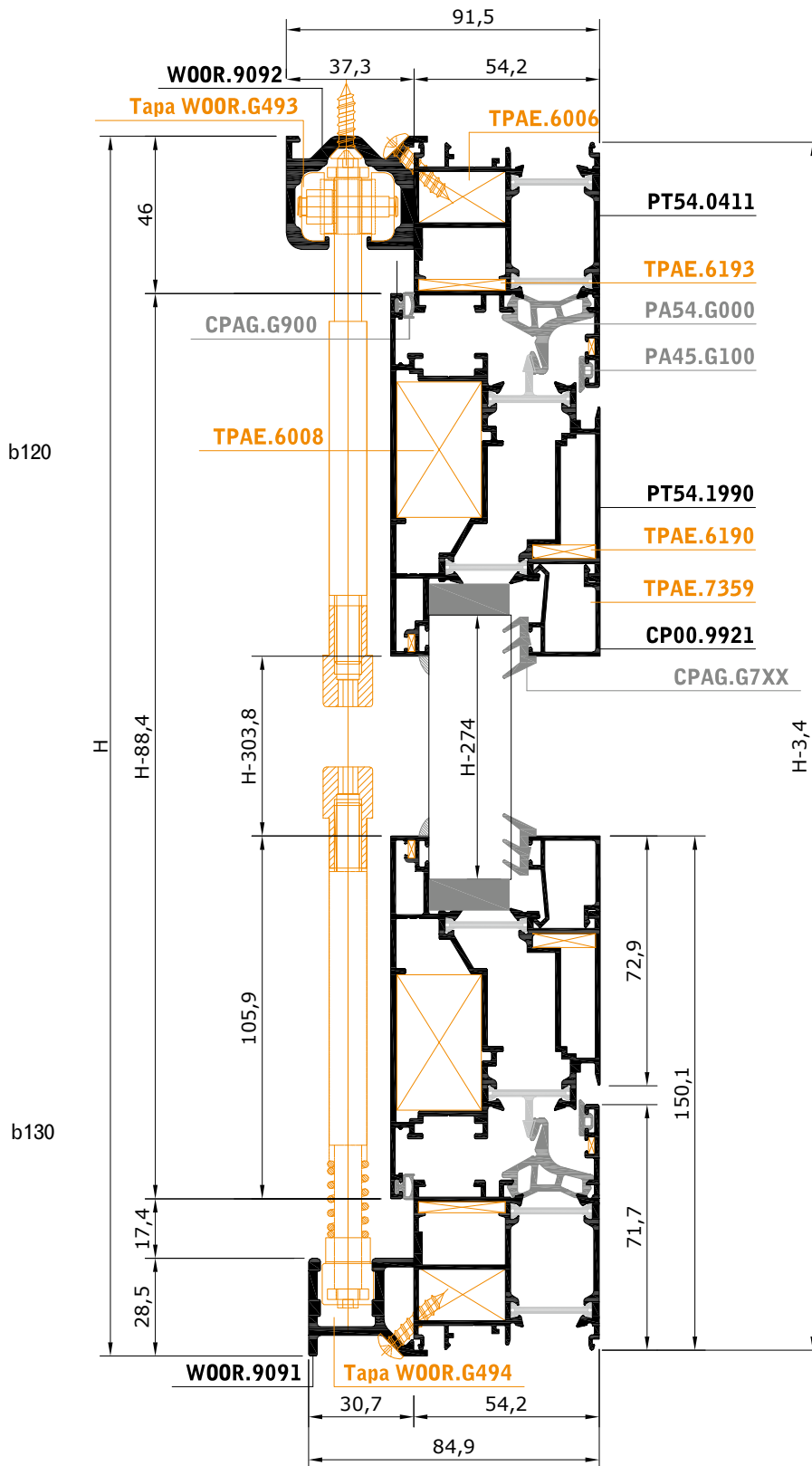

SECCIÓN VERTICAL b120-b130



PLEGABLE CON PEANA Y GUÍA EMPOTRADA. APERTURA EXTERIOR

PT54 (WOOR-9092;OM60-9091)

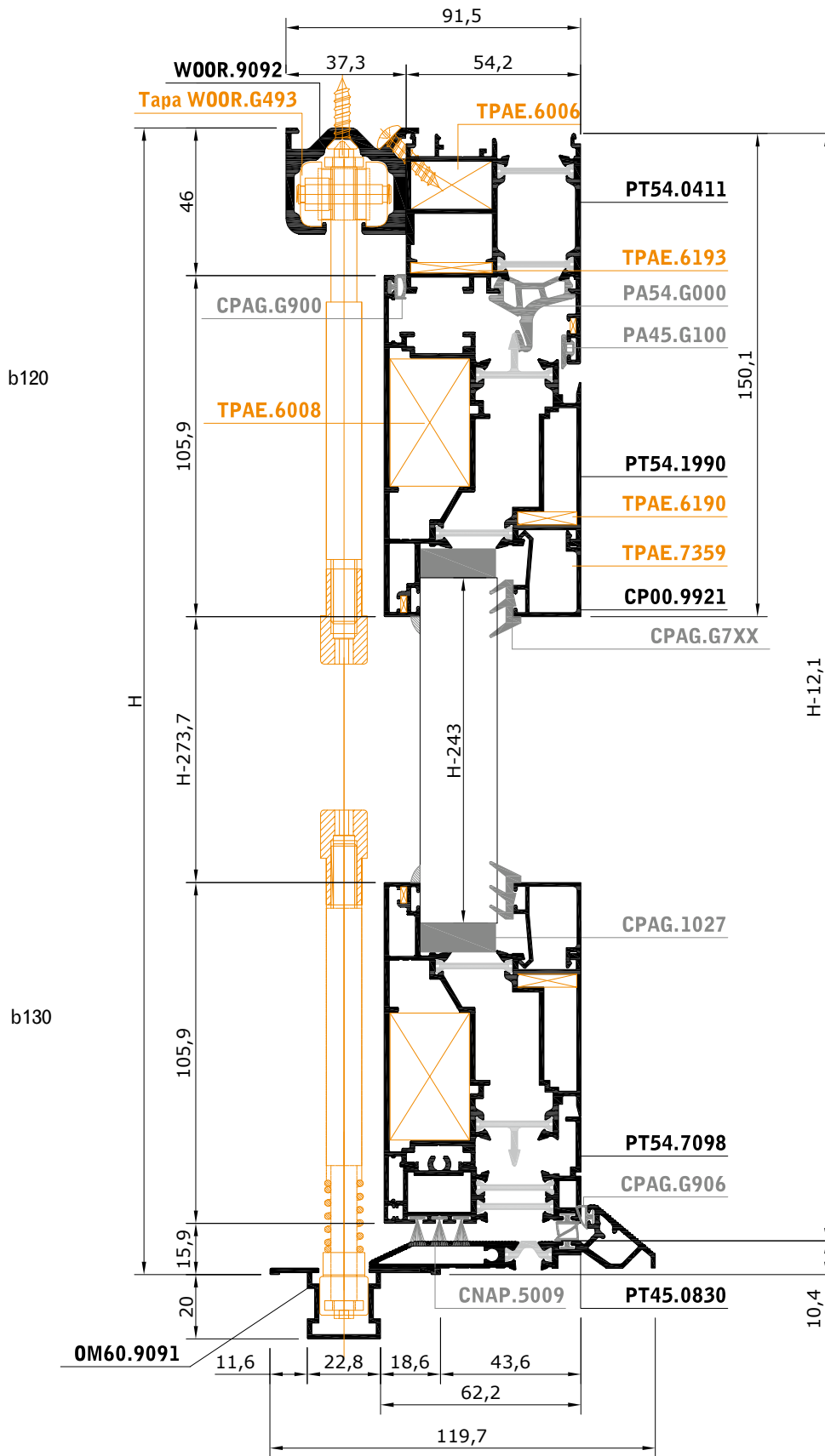

SECCIÓN VERTICAL b120-b130



PLEGABLE CON MARCO CERRADO Y GUÍA SOBREPUESTA. APERTURA EXTERIOR
PT54 (WOOR-9092;WOOR-9091)

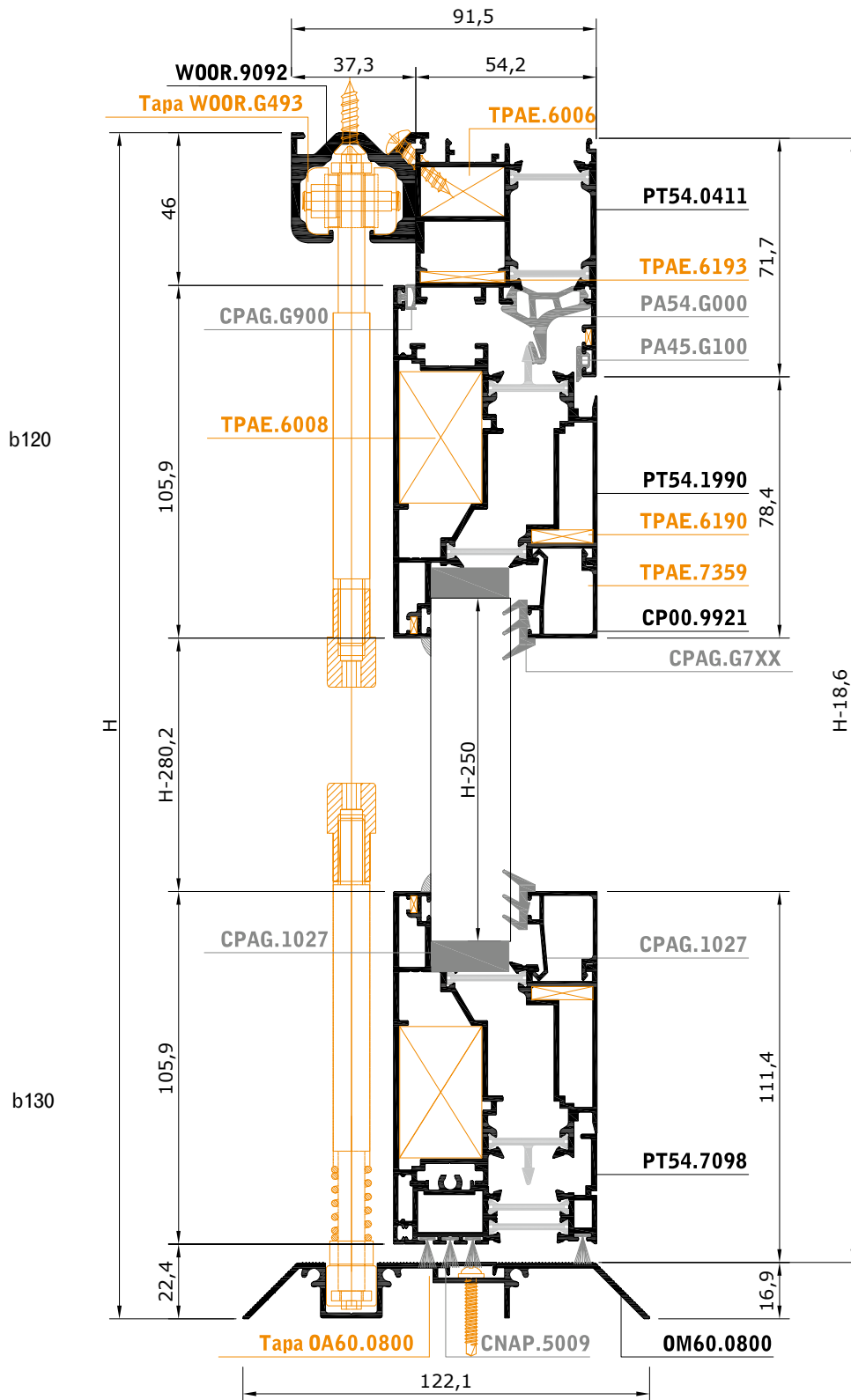

SECCIÓN VERTICAL b120-b130



BISAGRA WOOR-9826
MARCO / HOJA

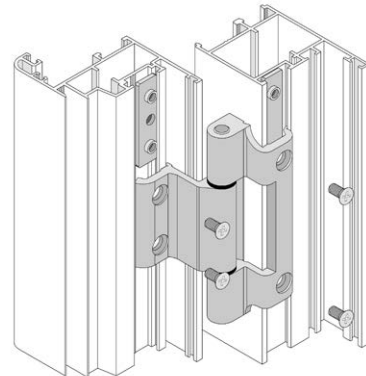

BISAGRA WOOR-9826T
INVERSOR / HOJA

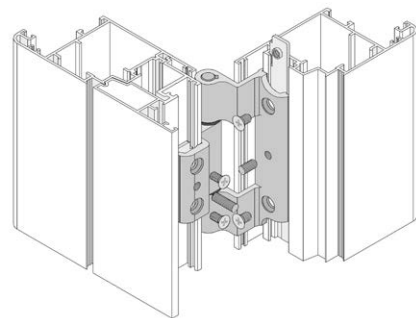

BISAGRA WOOR-9827
INVERSOR / HOJA SOBREPUESTA PARA HOJAS VENTANA PF43-1160;1190;PT45/54/5+/80-1160;1190

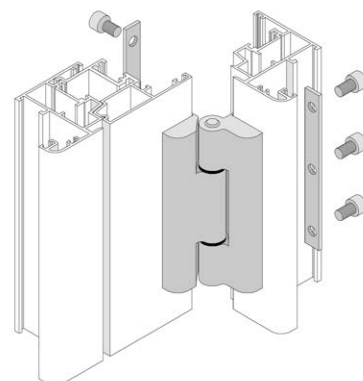



PROVISIONAL 16/10/2024

BISAGRA WOOR-9827H

INVERSOR / HOJA SOBREPUESTA PARA HOJAS DE PUERTA PF43-1360;1390;1960;1990:PT45/54/5+-1360;1390;1990

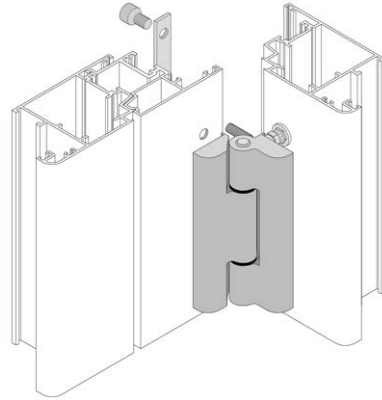

JUEGO DE CARROS SUPERIOR / INFERIOR WOOR-1352

HOJA / INVERSOR

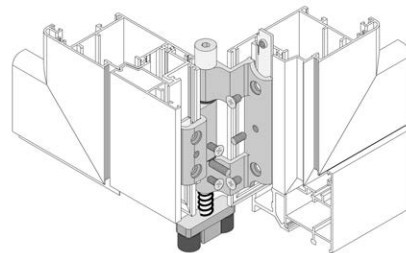
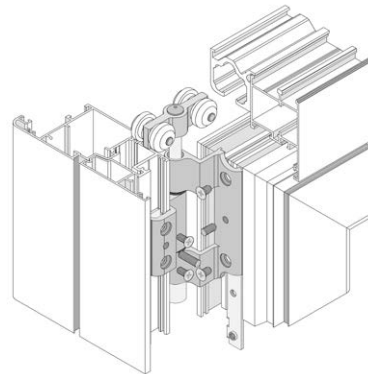



JUEGO DE CARROS SUPERIOR / INFERIOR WOOD-1352T
FINAL SOBRE INVERSOR

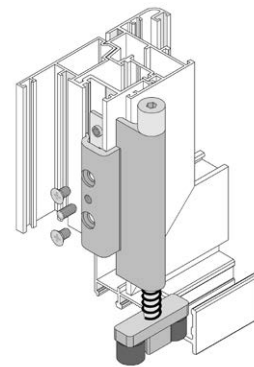
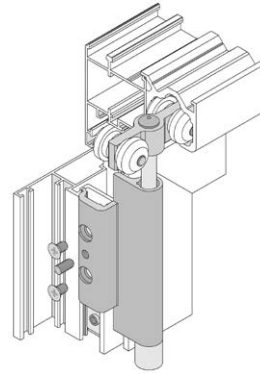

JUEGO DE CARROS SUPERIOR / INFERIOR WOOD-1352H
FINAL SOBRE HOJA

